

Practical Computing

60p

January 1981

Volume 4 Issue 1

**Chips in the
submicron age**

**Reviews:
WordPro 4
PetDOS
Sord
SBC-100**

**Estate agent
on a micro**

**Software
for maths
teaching**

**New—
Micromouse
page**

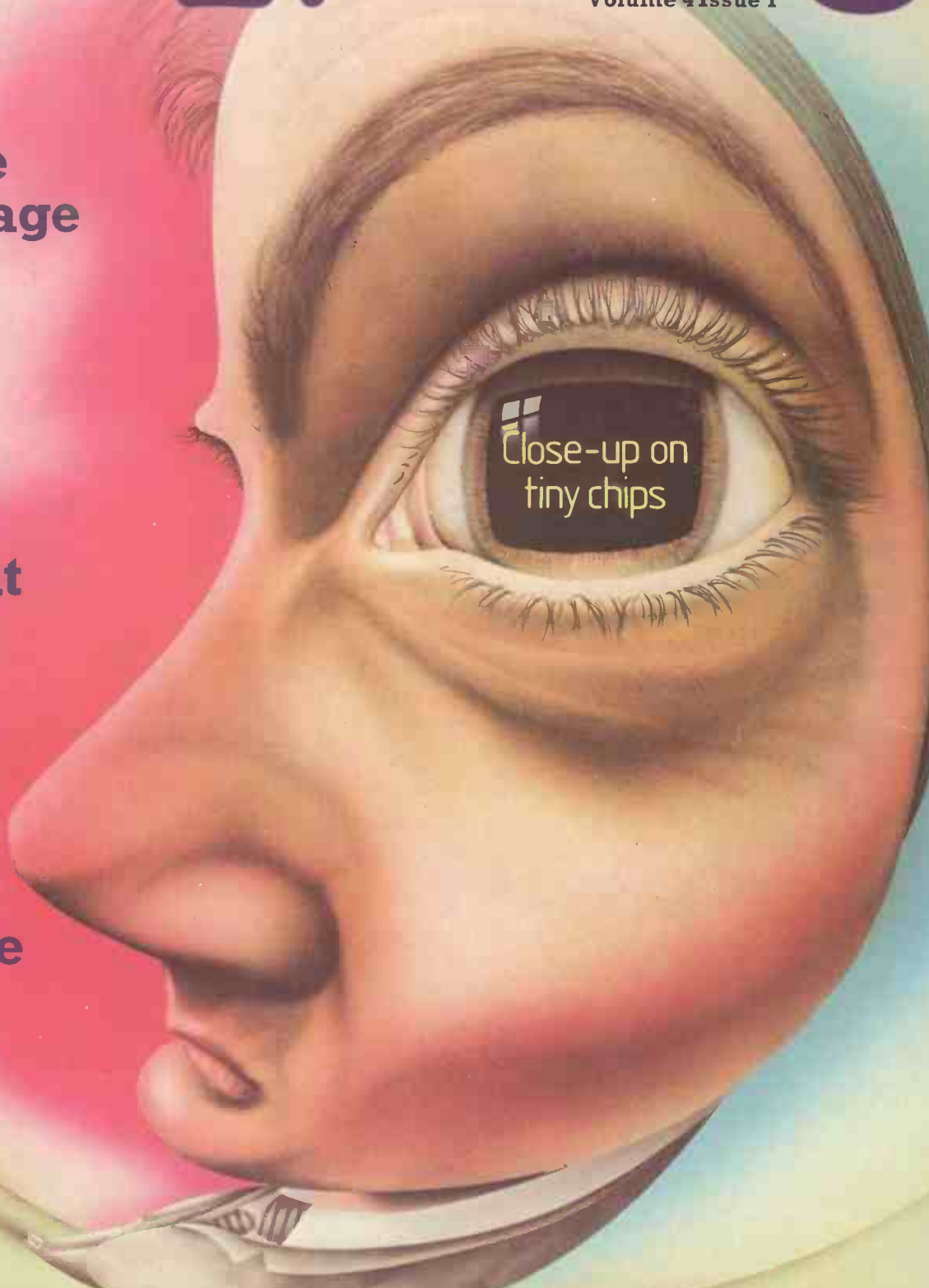

Close-up on
tiny chips

The best computers **PLUS** the best service

At MicroCentre, we're concentrating our resources on what we genuinely believe are the very best computers available today. . . . Cromemco computers, naturally. This way we can offer you the best deal possible.

What we don't do

What we don't do is spread our expertise thinly amongst umpteen different systems, or try to stock every S100 product on the market. We don't claim to offer "impartial" advice on the best buy. And we don't sell from price lists or catalogues.

The MicroCentre approach

Some micro-computer suppliers work like that, but we don't. Because we realise that when you're buying a computer you want more than the "brochures and boxes" approach. You want to see computers running; to try them out with different software products; to study the documentation; above all, you want expert answers to your most searching questions.

Cromemco specialists

That's why we've specialised in Cromemco systems. Not simply because we think Cromemco systems are the best serious computers available at the price.



Cromemco Model Z-2H hard disc computer. 10 megabyte hard disc, 2 floppy discs, Z-80 computer and 64K memory. MicroCentre price £5,326.

But because by doing so we can dedicate our time, energy and resources to giving you the highest standard of Cromemco support possible.

demonstration; expect the full range of Cromemco peripherals; single-user and multi-user systems; and interactive graphics.

Demonstrations

So when you visit MicroCentre expect to find Cromemco systems on permanent

Software

Expect a choice of operating systems and compilers to evaluate; expect complete documentation; and expect the largest collection of Cromemco systems software in the UK.

Expertise

Expect to find in-depth professional expertise at MicroCentre, the kind that is only acquired by installing Cromemco systems all over Britain. Expect a thorough appreciation of how Cromemco systems can be applied . . . in business, scientific research, industrial engineering, medicine and education.

Support

Expect to get frank, accurate answers to your questions at MicroCentre. Above all, once you've bought a Cromemco system from us, expect to get a very high standard of technical support with your hardware enhancements and continuing software needs.

At MicroCentre, simply expect the best.



MicroCentre's Cromemco demonstration room, with the full range of Cromemco computers, peripherals, operating systems and software products on permanent exhibition. Why not pay us a visit? We're only an hour's Shuttle flight from Heathrow!

For  **Cromemco... call the experts**

**NOW IN SPACIOUS
NEW SHOWROOMS**

Tel. 031-556 7354

MicroCentre

**STILL IN
CENTRAL EDINBURGH**

Complete Micro Systems Ltd., 30 Dundas Street, Edinburgh EH3 6JN

● Circle No. 101

Practical Computing

Chips in the submicron age

Reviews:
WordPro 4
PetDOS
Sord
SBC-100

Estate agent on a micro
Software for maths teaching

new mouse

Close-up on chips — page 68

Editor

Peter Laurie

Assistant Editor

Duncan Scot

Production Editor

Toby Wolpe

Prestel Editor

Martin Hayman

Editorial Secretary

Tracy Ebbetts

Consultants

Technical **Nick Hampshire**

Software **Mike McDonald**

Editorial: 01-661 3144

Advertisement Manager

Tom Moloney

Advertisement Executives

David Lake

Philip Kirby

Advertising: 01-661 3500

Midlands office:

David Harvett 021-356 4838

Northern office:

Ron Southall 061-872 8861

Publisher

Chris Hipwell

Published by IPC Electrical Electronic Press Ltd, Quadrant House, The Quadrant, Sutton, Surrey, SM25AS. Tel: 01-661 3500. Telex/grams 892084 BIPRESG.

Typesetting and artwork by Bow-Towning Ltd, London EC1
Printed by Eden Fisher Ltd, Southend-on-Sea

Distributed by IPC Sales and Distribution Ltd, 40 Bowling Green Lane, London EC1R 0NE

Subscriptions: U.K., £8 per annum; Overseas £14 per annum; airmail rates available on application to Subscription Manager, IPC Business Press (S & D) Ltd, Oakfield House, Perrymount Road, Haywards Heath, Sussex RH16 3DH, tel 0444 59188

© IPC Business Press Ltd 1981

ISSN 0141-5433

Would-be authors are welcome to send articles to the Editor but PC cannot undertake to return them. Payment is at £30 per published page. Programs intended for publication should ideally be justified to 22 or 44 or 66 characters per line.

Submissions should be typed or computer-printed. Hand-written material is liable to delay and error.

Every effort is made to check articles and listings but PC cannot guarantee that programs will run and can accept no responsibility for any errors.

CONTENTS

- 41** Editorial/The advancing frontier
- 42** Feedback/Currency interest; Basic burial; challenge of ZX-80
- 46** Printout/New Rair Black Box III range; MUSE advice centre; Comart Communicator
- 55** Printout extra/We look at the latest developments in the nebulous area of software copyright
- 57** WordPro 4/Nick Hampshire's view of the word-processing package from Professional Software
- 60** SCDS PetDOS / A complete disc-operating system and assembler for Pet reviewed by Andrew and David Trott
- 64** Sord / The M223 mark II from Japan put through its paces by David Martland
- 66** SBC-100 / An evaluation by Andrew Stephenson of the Z-80 computer
- 68** Chips in the submicron age / Peter Laurie on how microprocessors are made and how the wondermachines of the 1990s will be powered
- 76** Applications / Estate agent on a micro
- 83** Run-stop key / Two programs from Jonathan Dick to generate control characters
- 84** Education / MP Thorne looks at the quality of maths packages
- 86** Invoices, circulars and letters / Programs for the Commodore printer presented by Rex Tingey
- 93** TRS-80 and printers / How to put the Tandy on-line by Ian Sinclair
- 96** Mobile display / Displays on memory-mapped screens by GJ Marshall
- 102** Three-dimensional games / A 3D noughts and crosses program
- 104** Hamming code / John and Timothy Lee discuss error detection and correction
- 106** Intelligent design / Mark Josephs explains the ways in which game positions may be represented
- 109** Z-80 Zodiac
- 111** ZX-80 Line-up
- 114** Tandy Forum
- 119** 6502 Special
- 121** Apple Pie
- 122** Pet Corner
- 125** Micromouse
- 126** Book Reviews
- 129** Machine code / The ninth part of David Peckett's series
- 136** Microcomputer Buyers' Guide
- 148** The Hexadecimal Kid / Page 4 of the parable in eight virtual pages
- Prestel page number 45631

PROFESSIONAL SUPERBRAIN SOFTWARE

COMPILERS & UTILITIES

Microfocus CIS COBOL:	
— Standard Compiler	£425
— Forms-2 utility	£100
CIS COBOL Report Generator	£250

N.B. We are the approved UK distributors of Microfocus products on the SUPERBRAIN.

Microsoft:	
— MBASIC interpreter	£170
— BASIC 80 compiler	£210
— COBOL 80 compiler	£390
— FORTRAN 80 compiler	£270

Micropro:	
— WORDSTAR (word-processing)	£250
— Mailing list merge for above	£75
— DATASTAR (data management)	£175

CONSULTANCY/PROJECT WORK

We provide the full range of consultancy and project work services from initial systems analysis through programming to final implementation. Ask us for a quotation.

APPLICATIONS SOFTWARE

The Micro Solution Ltd (CIS COBOL):	
— Bill of Materials	£450
— Stock Control	£450
— Report Generator	£250

Bell Business Systems (BASIC):	
— Complete Integrated Accounting System (inc. 1 days onsite installation and training)	£1000

PR Daly (BASIC):	
— Stock Control	£350
— Sales Ledger	£350
— Purchase Ledger	£350
— Nominal Ledger	£500
— Payroll	£350
— Time Recording	£500
— Invoicing	£200

ROGIS Systems:	
— Stock Control	£475
— Estate Agents System	£475

2% DISCOUNT FOR CASH WITH ORDER
WE PROVIDE 24 HR TURNROUND ON MOST PRODUCTS PLUS TELEPHONE SUPPORT
ADD VAT AT STANDARD RATE TO ALL PRICES

Contact:



Park Farm House
Heythrop
Chipping Norton
OXFORDSHIRE
OX7 5TW

telephone:
CHIPPING NORTON (0608) 3256
ask for: Bill Whaley
or
Bede Dunlop

• Circle No. 102

The  Cromemco

Z-2H

THE
MARKET
LEADER



**11 Megabytes of hard disc storage in a fast,
new, table-top computer.**

- Fast Z80A 4MHz processor
- 11-megabyte hard disc drive
- Two floppy disc drives
- 64K RAM memory
- RS-232 serial interface
- Printer interface
- Extensive software available

Camberley	Microbits, Camberley, Surrey 0276 34044
Cambridge	Cambridge Computer Store, Cambridge 0223 68155
Dublin	Lendac Data Systems Ltd., Dublin 372052
Ilford	The Byte Shop, Ilford, Essex 01-554 2177 also at Tottenham Court Road, London 01-636 0647
Leeds	Holdene Ltd., Leeds 0532 459459 also at Wilmslow, Cheshire 0625 529486
London	Digitus Ltd., London W1 01-636 0105
Manchester	Computer Workshop, Manchester 061-832 2269 also at West Park, Leeds 0532 788466
Newbury	Newbear Computing Store, Newbury, Berks 0635 30505
Newport	Micromedia Systems, Newport, Gwent 0633 50528
Nottingham	Computerland Ltd., Nottingham 0602 40576 also at Birmingham 021-622 7149; Manchester 061-236 4737; Glasgow 041-332 2468
Sheffield	Hallam Computer Systems, Sheffield 0742 663125
Southampton	Xitan Systems Ltd., Southampton 0703 38740
St. Austell	Benchmark Computer Systems Ltd., St. Austell 0726 61000



comart specialists in microcomputers

Comart Ltd., P.O. Box 2, St. Neots, Huntingdon, Cambs, PE19 4NY. Tel: (0480) 215005 Telex: 32514

● Circle No. 103

The b



TRS-80 Model I
from £379
4K Level I
£559
16K Level II
(illustrated).

£559.00*
(16K Level II)

TRS 80 Model I Microcomputer Here's the push button brain, the entertainer, the tutor, the timesaver. Fun for the children, a helper for the businessman and the teacher, a catalogue for the housewife, an analyser for the investor and an informer for the salesman. Run Maths, English, Chess, Draughts and video game programmes for educational fun. Easy to learn and operate — you can even write your own programmes. Suddenly you have a ready and reliable source of brainpower — put it to work immediately.



TRS 80 Model I C.P.U.'s Complete and ready to run from your TV monitor. Just plug in and start computing. The lowest priced 4 K level I CPU contains 4096 bytes of user memory and can be expanded to 16K within the keyboard unit. The 16K level II CPU is a more powerful and flexible version using an additional 12K ROM. Level II also incorporates a calculator style numeric keypad for faster data entry.

rains.



TRS 80 Model II Microcomputer A bigger, more powerful brother to Model I. Designed for more data storage and versatility. Like Model I it is completely modular allowing easy, plug-in expansion. It's available memory will allow maximum use of future languages.

TRS-80 COMPUTER CENTRES NOW OPEN AT—
Birmingham—Edgbaston Shopping Precinct, Hagley Road.
Bradford—214, Forster Square.
Bristol—Colston Centre, Colston Avenue.
London—1-2, Seacoal Lane, Ludgate Hill, EC4.
Manchester—30, Market Place, Deansgate.
Southampton—East Street Centre.

FULL COMPUTER FACILITIES AVAILABLE AT—
Dowend—5, Badminton Road, Downend, Bristol.
Leeds—72, Merrion Centre.
Liverpool—168, Market Way, St. Johns Centre.
Wednesbury—Bilston Road.
Wimbledon—124-126, The Broadway, London, SW19.

*All prices include VAT.

IT'S POSSIBLE, ONLY AT Tandy

Better Equipment. Lower Prices. No Middlemen.

• Circle No. 104

NANOCOMPUTER[®]

THE COMPUTER FOR LEARNING ALL ABOUT COMPUTERS.

The microprocessor boom has left in its wake a scarcity of engineers who need to know how to realise to the full the potential of these powerful devices.

SGS-ATES, who have been producing microprocessors longer than any other European manufacturer, are now producing the NANOCOMPUTER, a professional and complete educational microcomputer system specially designed for learning all about microcomputers.

Teaching and Learning: two facets of a single problem.

All learning must be a blend of teaching reinforced with practical training.



NBZ80-S. CPU board, experiment board, keyboard, card frame/power supply, connecting wires, training books Vol. 1 and 3, Technical Manual.

The NANOCOMPUTER has been designed to be both tutor and training aid.

It is the result of SGS-ATES many years experience not just in component and systems production but also in the training of both design and production engineers at the very highest level.

The NANOCOMPUTER, based on the powerful Z80 microprocessor produced by SGS-ATES, is not just a microcomputer but rather a complete, modular educational system designed to grow with the student.

It comes complete with text books in the major European languages, technical manuals and experiment kits.

All these features make the NANO-

COMPUTER an obvious choice not only for supervised courses in schools but also for the engineer who wants to learn in a more personal way all about micro-computers.

NANO-COMPUTER: a modular system.

The conceptual design of the NANOCOMPUTER, specially created for educational use, combines the exactness of science with the flexibility demanded by the learning process which must be at the same time both theoretical and practical.

The NANO-COMPUTER in its simplest form, NBZ80-B, allows even the newcomer to micro-processors to master programming techniques.

Further up the scale the NBZ80-S introduces him to logical circuits then takes him on to learning how to interface a microprocessor with external devices.

Each learning step taken by the stu-

dent is matched by the NANOCOMPUTER which has been designed for expansion, with a series of upgrade kits, from the simple NBZ80-B through to the NBZ80-S onto a final version with which he can learn not just about programming in the BASIC high-level language but how to use it as an integral part of a hardware system.



NBZ80-B. CPU board, keyboard, card frame/power supply, training book Vol. 1, Technical Manual.



NBZ80-HL. As NBZ80-S, with 16k bytes of RAM, expansion board with 8k BASIC ROM, video interface board, alphanumeric keyboard, book "BASIC Programming Primer". (TV monitor is optional).

Please send more information about your NANOCOMPUTER® PCI/81

Name _____ Address _____

City _____ Country _____

Profession _____

Send to: SGS-ATES (UK) Ltd.
Planar House - Walton Street
Aylesbury - Bucks.
Tel. (0296) 5977



SGS-ATES (UK) Ltd. - Planar House - Walton Street - Aylesbury - Bucks - Tel.: (0296) 5977 - Telex 83245. • SPECIALIST MICROPROCESSOR DISTRIBUTORS: Cambridge Microcomputers Ltd. - Cambridge Science Park - Milton Road - Cambridge - Tel. (0223) 314666 • Midwich Computer Company Ltd. - 9 Churchgate Street - Old Harlow - Essex CM17 0JS - Tel. (0279) 412605 • Distrionic Ltd. - 50/51, Burnt Mill - Elizabeth Way - Harlow - Essex - Tel. (0279) 32947 - Telex 81387 • Quarndon (Semiconductors) Electronics Ltd. - Slack Lane - Derby DE3 3ED - Tel. (0332) 32651 - Telex 37163.

"The salesman spoke very highly about our new computer."



At Micro-C we'll give you unbiased, honest advice about micro-computers. Not a sales pitch.

"Unfortunately, my guarantee only lasts 90 days."



At Micro-C, we guarantee micro-computers for one full year.

"My computer is printing out gibberish"



At Micro-C, we test all software. If it isn't easy to understand or free from errors, we won't stock it.

"Unfortunately, I didn't buy my computer from Currys!" or more of our micro systems can tackle your needs. Maybe it'll be the ITT 20 20 or the Apple II with which you can keep books, tackle incomplete accounts and through Visicalc, work on financial planning and modelling.

At Currys' Micro-C, before we talk about hardware or software, we'll talk about your business, or practice.

(It's the only way we know to make sure the micro you choose is the micro you want.)

Next, we'll demonstrate how one

less, the Commodore Pet might do the job for you.

Again, it'll handle book-keeping, word processing, and incomplete records.

If your business is more complex

"Service contracts,
what service contracts?"

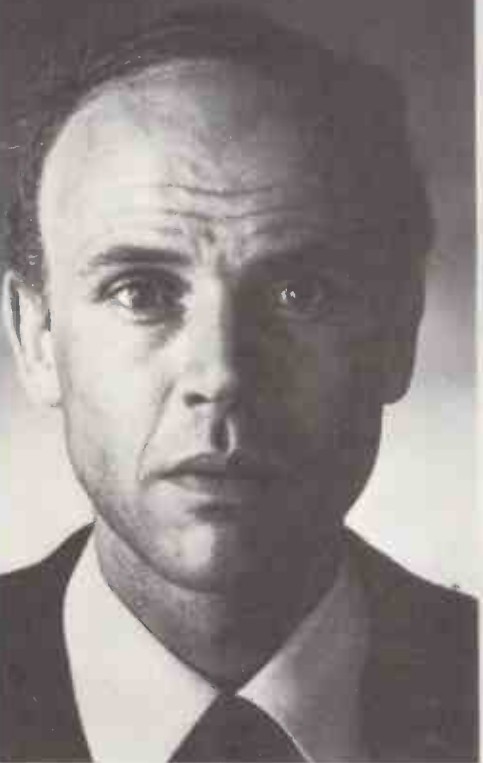

At Micro-C, we can maintain machines regularly. For a little extra, we'll guarantee to be there within one working day.

"The shop I bought it from has disappeared"

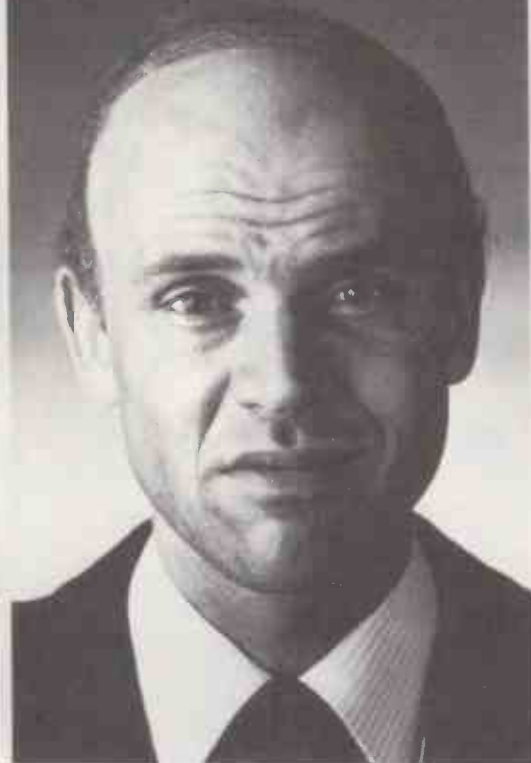

At Micro-C, we're part of the Currys Electrical Group. When you need us we'll be there.

"My boss says I'm fired."



we might talk about the National Panasonic JD800, or JD840, or our new Micro-C 2000. They do all that the others do and offer fully integrated accounting, stock control and management information facilities.

We'll back them all with the guarantees and promises you can read above, together with one or two you can't.

For example, we help with staff-training so that the change-over is smooth and easy.

At the same time, we'll offer any numbers of ways to buy or lease, starting at around £35 a week.

Come and see us for a free demonstration. Before our cautionary tale turns into a True Life story.

The new Micro-C shops.
At Birmingham, Bristol, Exeter, Leeds, New Malden, Nottingham, Luton, Manchester, Southampton.

To Currys Micro-Systems Limited, 653 London Road,
High Wycombe, Bucks HP11 1EZ

Please send me an information pack on your service and products

Please telephone to make an appointment

Name _____

Company _____

Address _____

Telephone _____

PC2



COMPUTERS EXPLAINED BY HUMAN BEINGS.

• Circle No. 106

In the microcomputer jungle The Sharp MZ-80 system now with



Since its introduction, the Sharp MZ-80 system has proved to be one of the most versatile systems in the micro jungle, for commerce, industry and enthusiasts alike.

Now the MZ-80 Computer system has even more versatility thanks to CP/M[™] giving greater adaptability to face the future. After all look what happened to the Dinosaur.



The MZ-80 system is made up of the MZ-80K computer with the powerful Z-80 microprocessor. MZ-80FD Floppy Disc storage unit, now with CP/M[™] for even greater versatility. MZ-80P3 dot printer producing ultra Sharp print out copy.

CP/M[™] is a Trade Mark of Digital Research Ltd and was developed by Crystal Electronics, Torquay.

survival depends on adaptability. CP/MTM has even greater versatility.



Your Sharp Microcomputer Dealers

• Circle No. 107

AVON
BCG SHOP EQUIPMENT LTD · BRISTOL ·
TEL: 0272 425338
DECIMAL BUSINESS M/CS LTD · BRISTOL ·
TEL: 0272 294591
BEDFORDSHIRE
SHERWOODS (H.B. COMPUTERS) LTD ·
LUTON · TEL: 0582 416202

BERKSHIRE
BCG SHOP EQUIPMENT LTD · READING · TEL: 0734 54015
NEWBEAR COMPUTING STORE LTD · NEWBURY ·
TEL: 0635 30505

BUCKINGHAMSHIRE
INTERFACE COMPONENTS LTD · AMERSHAM ·
TEL: 02403 22307

CHESHIRE
CASH REGISTER SERVICES · CHESTER · TEL: 0244 317549
FLETCHER WORTHINGTON LTD · HAILE · TEL: 061-928 8928
NEWBEAR COMPUTING STORE LTD · CHEADLE HEATH,
STOCKPORT · TEL: 061-491 2290

CLEVELAND
HUNTING COMPUTER SERVICES LTD · STOCKTON ·
TEL: 0642 613021

DEVON
BCG SHOP EQUIPMENT LTD · PAIGNTON · TEL: 0803 557711
CRYSTAL ELECTRONICS LTD · TORQUAY · TEL: 0803 226999
PETER SCOTT (EXETER) LTD · EXETER · TEL: EXETER 73309

DORSET
SOUTH COAST BUSINESS M/CS · FERNDOWN, DORSET ·
TEL: 0202 893040

ESSEX
PROROLE LTD · WESTCLIFFE ON SEA · TEL: 0702 335298

GLOUCESTER
GLOUCESTERSHIRE SHOP EQUIPMENT LTD ·
GLOUCESTER · TEL: 0452 36012

LANCASHIRE
B & B (COMPUTERS) LTD · BOLTON · TEL: 0204 26644
MICRODIGITAL LTD · LIVERPOOL · TEL: 051-227 2535
SUMITA ELECTRONICS LTD · PRESTON · TEL: 0772 55065
SUMLOCK SOFTWARE LTD · MANCHESTER ·
TEL: 061-228 3502
SOUND SERVICES · BURNLEY · TEL: 0282 38481

LEICESTERSHIRE
ARDEN DATA PROCESSING · LEICESTER · TEL: 0533 22255
GILBERT COMPUTERS · LUBENHAM · TEL: 0858 65894

LINCOLNSHIRE
HOWES ELECT. & AUTOM. SERVS. WASHINGTON ·
TEL: LINCOLN 32379

LONDON
C.S.S. BUSINESS EQUIPT LTD · LONDON · EB ·
TEL: 01-836 1176

CENTRAL CALCULATORS LTD · LONDON · EC2 ·
TEL: 01-729 5588
DIGITAL DESIGN & DEVELOPMENT · LONDON · W1 ·
TEL: 01-387 7388

EURO-CALC LTD · LONDON E C 2 · TEL: 01-729 4555
EURO-CALC LTD · LONDON W1 · TEL: 01-636 5560
EURO-CALC LTD · LONDON W C 1 · TEL: 01-405 3113
JAXREST LTD · LONDON EC1 · TEL: 01-403 1801
LION COMPUTER SHOPS LTD · LONDON W1 ·
TEL: 01-637 1601
PERSONAL COMPUTERS LTD · LONDON · TEL: 01-626 8121
SCOPE · LONDON EC2M 4HX · TEL: 01-247 8506
SUMLOCK BONDAIN LTD · LONDON EC1R 0AA ·
TEL: 01-253 2447
VIDEO SERVICES (BROMLEY) · TEL: 01-460 8833
CREAM COMPUTER SHOP · HARROW · TEL: 01-380 0833

NORFOLK
SUMLOCK BONDAIN (EAST ANGLIA) LTD · NORWICH ·
TEL: 0603 26259

NORTHAMPTONSHIRE
HB COMPUTERS LTD · KETTERING · TEL: 0536 83922

NOTTINGHAMSHIRE
KEEN COMPUTERS · NOTTINGHAM · TEL: 0602 583254
MANSFIELD BUSINESS M/CS LTD · MANSFIELD ·
TEL: 0623 26610

OXEN
MODES SCIENTIFIC CONSULTANCY · OXFORD ·
TEL: 0865 45172

SALOP
COMPUTER CORNER · SHREWSBURY · TEL: 0743 55166

SOMERSET
NORSETT OFFICE SUPPLIES LTD · CHEDDAR ·
TEL: 0934 742184

SUFFOLK
MICROTEK · IPSWICH · TEL: 0473 50152

SURREY
PETALECT ELECTRONIC SERVICES
WOKING · TEL: 04862 69032

R.B.M. DATA SERVICES ·
CROYDON · TEL: 01-584 1134
BARNES CONSULTANTS · GUILDFORD ·
SARADAN ELECTRONICS SERVICES ·
WALLINGTON · TEL: 01 669 9483

T & V JOHNSON (MICROCOMPUTERS) · CAMBERLEY ·
TEL: 0276 20446

SUSSEX
M & H OFFICE EQUIPMENT · BRIGHTON ·
TEL: 0273 697231

TYNE & WEAR
P.M.S. LTD · SUNDERLAND · TEL: 0783 480009

WALES
CITY RADIO · CARDIFF · TEL: 0222 28169
SIGMA SYSTEMS LTD · CARDIFF · TEL: 0222 21515

WEST MIDLANDS
CAMDEN ELECTRONICS · SMALL HEATH (BIRMINGHAM) ·
TEL: 021-773 8240

E.B.S. LTD · BIRMINGHAM · TEL: 021-233 3045
JAXREST LTD · BIRMINGHAM · TEL: 021-328 4908
NEWBEAR COMPUTING STORE LTD · BIRMINGHAM ·
TEL: 021-707 7170

POINTCRAFT · BIRMINGHAM · TEL: 021-233 2325

YORKSHIRE
DATRON INTERFORM LTD · SHEFFIELD · TEL: 0742 585490
BITS & P.C.S. · WETHERBY, W YORKSHIRE · TEL: 0937 63744

SCOTLAND
A & G KNIGHT · ABERDEEN · TEL: 0224 630526
BUSINESS & ELECTRONIC M/CS · EDINGURGH ·
TEL: 031-226 5454

FORTRONIC LTD · DUNFERMLINE · TEL: 0383 823121
STRATHAND LTD · GLASGOW · TEL: 041-552 6731

NORTHERN IRELAND
O & M SYSTEMS · BELFAST 49440

EIRE
TOMORROWS WORLD LTD · DUBLIN 2 ·
TEL: 00001 776861

ISLE OF MAN
DELTA SYSTEMS LTD · DOUGLAS · TEL: 0624 4586



SHARP **COMPUTER APPLICATIONS**

Find out today what a Sharp Microcomputer will do for you.



SUPERBRAIN™

Intelligent Video Terminal Systems

350K or 700K of Disk Storage

SuperBrain's CP/M operating system boasts an overwhelming amount of available software in BASIC, FORTRAN, COBOL, and APL. Whatever your application . . . General Ledger, Accounts Receivable, Payroll, Inventory or Word Processing, SuperBrain is tops in its class. And the SuperBrain QD boasts the same powerful performance but also features a double-sided drive system to render more than 700K bytes of disk storage and a full 64K of RAM. All standard!



COMPUSTAR™

MULTI-USER TERMINAL SYSTEM

CompuStar user stations can be configured in a countless number of ways. A series of three intelligent-type terminals are offered. Each is a perfect cosmetic and electrical match to the system. The CompuStar 10 — a 32K programmable RAM-based terminal (expandable to 64K) is just right if your requirement is a data entry or inquiry/response application. And, if your terminal needs are more sophisticated, select either our CompuStar 20 or CompuStar 40 as user stations. Both units offer dual disk storage in addition to the desk system in the CompuStar. The Model 20 features 32K of RAM (expandable to 64K) and 350K of disk storage. The Model 40 comes equipped with 64K of RAM and over 700K of disk storage. But, most importantly, no matter what your investment in hardware, the possibility of obsolescence or incompatibility is completely eliminated since user stations can be configured in any fashion you like — whenever you want — at amazingly low cost!

DISK STORAGE

Options for the Superbrain and CompuStar Video Terminal

"Backup" for the 20 megabyte Century Data drive is provided via the dual disk system housed in the CompuStar or the SuperBrain. The Control Data CMD Drive features a removable, front-insertable top loading cartridge of 16 megabyte capacity plus a fixed disk capacity of either 16 or 80 megabytes. Each drive is shipped equipped with an EIA and standard 19" rack mounting system and heavy duty chassis slide mechanisms to permit easy accessibility for fast and efficient servicing.

**** WIDELY USED IN UK AND USA****
 ****TESTED AND PROVEN****
 ****POWER AT YOUR FINGERTIPS****
 ****JUST COMPARE THIS LIST****

NO OTHER PROGRAM IN THE WORLD COMBINES THESE FEATURES IN ONE. MANY OTHER PROGRAMS, LESS INTEGRATED, DO NOT PROVIDE EVEN SOME OF THOSE FEATURES TO BE FOUND ON OUR 'BUS'.

- 1 = TOTAL INTEGRATION OF SALES 'PURCHASE' 'NOMINAL' 'STOCK' 'ADDRESSES ETC
- 2 = FULL RANDOM ACCESS ENABLES RETRIEVAL OF ANY RECORD IN A SECOND.
- 3 = FLEXIBLE PROMPTS ENABLES WORD CHANGE EVEN TO FOREIGN LANGUAGE.
- 4 = FILES MAY BE NAMED AND SET TO DRIVE DEFAULT, MAXIMISING STORAGE.
- 5 = EASY TO USE, MENU DRIVEN, NO SERIOUS NEED OF MANUAL.
- 6 = TESTED AND DEBUGGED IN MANY INSTALLATIONS WORLD WIDE.
- 7 = PRICED LESS THAN THE ACQUISITION OF A LIBRARY OF PROGRAMS.
- 8 = THE PROGRAM IS *** TOTALLY *** IN CORE, MAXIMISING DISK SPACE.
- 9 = CORE PROGRAM MEANS THAT DISKS MAY BE INTERCHANGED DURING USE.
- 10 = CORE PROGRAM MEANS YOUR MAIN DRIVE IS *** FREE *** FOR DATA.
- 11 = NUMEROUS REPORTS MAY BE GENERATED (EG: SALE LEDGERS UP TO 30).
- 12 = INVOICE PRODUCES IMMEDIATE STOCK UPDATE + DOUBLE JOURNAL ENTRY.
- 13 = REFERENCE ON INVOICES ENABLE COST CENTRE BUILD-UP ON LEDGERS.
- 14 = STOCK VALUATIONS AND RE-ORDER REPORTS EASILY GENERATED.
- 15 = BANK BALANCE AND REPORTS PLUS STANDARD MAILING FACILITIES.
- 16 = CUSTOMER STATEMENTS AND INVOICES PRINTED ON PLAIN PAPER.

**ALSO AT: GAMMA DATA SYSTEMS, DOLLARD HOUSE, WELLINGTON QUAY,
 DUBLIN 2. TEL DUBLIN 711877**

*** MAIN MENU DISPLAY ***

NEW! PRODUCED IN U.K. AND WIDELY USED IN ENGLAND AND U.S.A.
COMPLETE BUSINESS PAGE

INCLUDES EVERYTHING FROM INVENTORY & DATABASE MANAGEMENT TO SALES SUMMARY.
PROMPTS USER. VALIDATES ENTRIES. MENU DRIVEN
PET AND CP/M SUPERBRAIN, TRS80 II, N'STAR, IMS5000.
APPROXIMATELY 6-100 ENTRIES/INPUTS REQUIRE 2-4 HOURS WEEKLY AND ENTIRE BUSINESS IS UNDER CONTROL
* PROGRAMS ARE INTEGRATED: : SELECT FUNCTION BY NUMBER.

- | | |
|-------------------------------------|--|
| 01 = *ENTER NAMES & ADDRESSES | 13 = *PRINT CUSTOMERS STATEMENTS |
| 02 = *ENTER/PRINT INVOICES | 14 = *PRINT SUPPLIER STATEMENTS |
| 03 = *ENTER A'C RECEIVABLES | 15 = *PRINT AGENT STATEMENTS |
| 04 = *ENTER PURCHASES | 16 = *PRINT TAX STATEMENTS |
| 05 = *ENTER A'C PAYABLES | 17 = LETTER TEXT AREA |
| 06 = *ENTER 'UPDATE INVENTORY | 18 = ALTER VOCABULARIES |
| 07 = *ENTER 'UPDATE ORDERS | 19 = PRINT YEAR AUDIT |
| 08 = *ENTER 'UPDATE BANKS | 20 = PRINT PROFIT 'LOSS A'C |
| 09 = *REPORT SALES LEDGER | 21 = OPEN AREA |
| 10 = *REPORT PURCHASE LEDGER | 22 = PRINT CASHFLOW FORECAST |
| 11 = *INCOMPLETE RECORDS | 23 = ENTER PAYROLL (NO RELEASE) |
| 12 = *USER DBMS AREA | 24 = DISK SWAP 'EXIT' |

ENTER WHICH ONE?

- DATABASE MANAGEMENT INCLUDES
 **** FILE OR RECORD CREATE 'DELETE' 'AMEND' 'SEARCH' 'PRINT' 4 WAYS.
 **** INFORMATION RETRIEVAL ON ANY KEY RECORD OR PART THEREOF.
 **** AUTOMATIC CHECK TO PREVENT DOUBLE ENTRY TO FILE SYSTEM.
 **** DYNAMIC ALLOCATION OF INFORMATION CONSERVING DISK SPACE.

VERY FLEXIBLE. EASY TO USE
 G.W. COMPUTERS LTD. UK. ARE THE PRODUCERS OF THIS BEAUTIFUL PACKAGE.
 AUTHOR TONY WINTER (B.A.LIT;B.A.HON.PHIL).

- PET VER 3.00 LOW LEVEL INTEGRATION = 475.00
 PET VER 4.00 INCLUDES AUTO STOCK-UPDATE = 575.00
 PET VER 5.00 INCLUDES AUTO BANK UPDATE = 675.00.
 CPM VER 6.00 IN CORE, TRANSLATEABLE PLUS DBMS = 775.00.
 CPM VER 7.00 AUTO STOCK-UPDATE = 875.00.
 CPM VER 8.00 AUTO BANK UPDATE = 975.00.
 CPM VER 9.00 INCLUDES OPTIONS 19, 20, 22, 23. (LATER RELEASE).
 + + + EACH LEVEL AUGMENTS LOWER ONE

WE EXPORT TO ALL COUNTRIES CALLERS ONLY BY APPOINTMENT
 CONTACT TONY WINTER ON 01.636.8210
 89 BEDFORD COURT MANSIONS; BEDFORD AVENUE, LONDON W.C.1.

NOTE!!! LEVEL 9.00 TOTALLY IN CORE PROGRAM LEAVES MASTER DRIVE FREE (SAVING OF 200 POUNDS HARDWARE).

IMPORTANT!!! NO COMPUTER HARDWARE IS EVER OF VALUE WITHOUT SOFTWARE, SO WE PROVIDE YOU
 WITH A STARTING SET OF PROGRAMS **** FREE ****. AT TEN % OF HARDWARE PURCHASED. A
 SUPERBRAIN AND NEC SPINWRITER COULD GIVE YOU UP TO 400 POUNDS OF PROGRAMS. SEE ()

PET + PET + PET + PET + PET	SOFTWARE +	SOFTWARE	SUPERBRAIN +	SUPERBRAIN
CBM 3032 32K 595.00	BUS VER 3.00 PET 475.00		SUPERBRAIN 320K 1695.00	
CBM 3040 DISKS 595.00	BUS VER 4.00 PET 575.00		TWIN Z80 32K + CRT	
CBM 3022 PRINTER 425.00	BUS VER 5.00 PET 675.00		+ 2 D'D-S'S DRIVE	
CBM 8032 32K 875.00	BUS VER 6.00 CP/M 775.00		SUPERBRAIN 320K 1795.00	
CBM 8050 1MEG DISKS 875.00	BUS VER 7.00 CP/M 875.00		TWIN Z80 64K + CRT	
CBM EPSON PRINTER 395.00	BUS VER 8.00 CP/M 975.00		+ 2 D'D-D'S DRIVE	
CBM MULTI USER 650.00	BUS VER 9.00 CP/M 1075.00		SUPERBRAIN 800K 2195.00	
CBM 3032 + EPSON +	CBM WORDPRO II 75.00		TWIN Z80 64K + CRT	
CBM 3040 + BUS V3 2215.00	CBM WORDPRO III 150.00		+ 2 D'D-D'S DRIVE	
	CPM WORD-STAR 195.00		SUPERBRAIN 1600K 2795.00	
PRINTERS + PRINTERS + PRINTERS	CPM MBASIC 80 150.00		COMPUSTAR 10 1595.00	
DIABLO 630 40 CPS 1595.00	CPM COBOL 80 320.00		COMPUSTAR 15 1495.00	
DOLPHIN BD80 125CPS 495.00	CPM PASCAL MT 150.00		COMPUSTAR 20 2295.00	
NEC 5510 PRINTER 1695.00	CPM FORTRAN 80 200.00		COMPUSTAR 30 2495.00	
MICROLINE 80 120CPS 475.00	CPM DATASTAR 175.00		COMPUSTAR 40 2795.00	
TELETYPE 43SR 30CPS 875.00	CPM PASCAL-M 250.00		INTERTUBE III 495.00	
DEC-LA34 TRACT 30CP 875.00	CPM BYSTAM S'BRAIN 75.00		EMULATOR 495.00	
NEC-5530PRINTER 1595.00	CPM SUPERSORT 120.00		10 MEG H'DISK 2950.00	
QUME DAISY SPRINT5 1950.00	CPM BASIC COMPILER 190.00		16 MEG (8'8) 3950.00	
TEXAS 810 150CPS 1390.00	CPM DESPOOL 30.00		96 MEG (4DISK) 7950.00	
	CPM BYSTAM IMS'N-STAR 75.00		(ADDRESS'MAILER) 95.00	
SPECIALS + SPECIALS + SPECIALS	CPM TEXTWRITER 75.00		(STOCK CONTROL) 95.00	
N'STAR QUAD .7 MEG 1500.00	CPM POSTMASTER 75.00		(DBMS DATABASE) 195.00	
IMS 5000 48K d'D 1200.00	CPM SELECTOR 3 180.00		IEEE TO PARALLEL 55.00	
COMPUTHINK *800K* 795.00	CPM CBASIC 75.00		IEEE 'RS232 BI'DI 195.00	
2 WAY CRDLESS PHONE 135.00	CPM MACRO 80 75.00		IEEE TO RS232 75.00	
TELEPHONE ANSWER 230.00	CPM W'STAR M'MERGE 245.00		S'HAND SWTP TERM 100.00	
SHUGART SA400 5' DR 135.00			WARRANTY	
	BUS MANUAL ***** 9.00		6 MONTH FULL REPAIR ***	

SPECIAL INSTITUTION AND UNIVERSITY DISCOUNTS + + + + +
 MOST ITEMS IN STOCK. (ACCESS/ AMEXCO/ BCLYCARD OTHERWISE CHEQUE WITH ORDER)
 CONTACT TONY WINTER 01.636.8210
 89 BEDFORD COURT MANSIONS, BEDFORD AVE W.C.1.

Mail Order Software

from the world's leading microsoftware supplier

- | | Software
with
Manual
Alone | | Software
with
Manual
Alone | | Software
with
Manual
Alone |
|---|-------------------------------------|--|-------------------------------------|---|-------------------------------------|
| DIGITAL RESEARCH | | | | | |
| CP/M* FOOS — Diskette Operating System complete with Text Editor, Assembler, Debugger, File Manager and system utilities. Available for wide variety of disk systems including North Star, Helios II, Micropolis, ICOM (all systems) and Altair. Supports computers such as Sorcerer, Horizon, Cromemco, Ohio Scientific, RAIR Black Box, Research Machines, Dynabyte, etc. from £75/£15 | | WORD MASTER Text Editor — In one mode has super-set of CP/M's ED commands including global searching and replacing, forward and backwards in file. In video-mode, provides full screen editor for users with serial addressable-cursor terminal £75/£15 | | ANALYST — Customised data entry and reporting system. User specifies up to 75 data items per record. Interactive data entry, retrieval and update facility makes information management easy. Sophisticated report generator provides customised reports using selected records with multiple level breakpoints for summation. Requires CBASIC-2, 24 x 80 CRT, printer and 48K system £125/£10 | |
| CP/M version 2 (not all formats available immediately) £95/£15 | | WORD-STAR — Menu driven visual word processing system for use with standard terminals. Text formatting performed on screen. Facilities for text paginate, page number, justify, center, underscore and PRINT. Edit facilities include global search and replace, read/write to other text files, block move, etc. Requires CRT terminal with addressable cursor positioning £255/£15 | | LETTERIGHT — Program to create edit and type letters or other documents. Has facilities to enter, display, delete and move text, with good video screen presentation. Designed to integrate with NAD for form letter mailings. Requires CBASIC-2 £105/£15 | |
| CP/M for Apple 11* Softcard with 280 Microsoft BASIC - 80 with high resolution graphics £250/£15 | | WORD-STAR/MAIL-MERGE — As above with option for production mailing of personalised documents with mail list from Dastatar or NAD £315/£15 | | NAD Name and Address selection system — Interactive mail list creation and maintenance program with output as full reports with reference data or restricted information for mail labels. Transfer system for extraction and transfer of selected records to create new files. Requires CBASIC-2 £45/£12 | |
| MP/M £195/£25 | | DATASAR — Professional forms control entry and display system for key-to-disk data capture. Menu driven with built-in learning aids. Input field verification by length, mask, attribute (i.e. uppercase, lowercase, numeric, auto dup., etc.). Built-in arithmetic capabilities using keyed data, constants and derived values. Visual feedback for ease of forms design. Files compatible with all CP/M-MP/M supported languages. Requires 32K CP/M £195/£25 | | QSORT — Fast sort/merge program for files with fixed record length, variable field length information. Up to five ascending or descending keys. Full back-up of input files created. Parameter file created optionally with interactive program which requires CBASIC-2. Parameter file may be generated with CP/M assembler utility £50/£12 | |
| MAC — 8080 Macro Assembler. Full Intel macro definitions. Pseudo Ops include RPC, IRP, REPT, TITLE, PAGE, and MACLIB. Z-80 library included. Produces Intel absolute hex output plus symbols file for use by SID (see below) £55/£10 | | GRAFFCOM | | | |
| SID — 8080 symbolic debugger. Full trace, pass count and break-point program testing system with back-trace and histogram utilities. When used with MAC, provides full symbolic display of memory labels and equated values £45/£10 | | PAYROLL — Designed in conjunction with the spec for PAYE routines by HMI Taxes. Processes up to 250 employees on weekly or monthly basis. Can handle cash, cheque or bank transfer payments plus total tracking of all year to date figures. Prints emp master, payroll log, payslips and bank giro. Requires CBASIC-2 £475/£35 | | SOFTWARE SYSTEMS | |
| ZSID Includes Z80 mnemonics, requires Z80 CPU £50/£10 | | COMPANY SALES — Performs sales accounting function. Controls payments of invoices and prints sales ledger and aged debtors report. Suitable for any accounting period. Comprehensive VAT control and analysis of all sales invoices. Requires CBASIC-2 £425/£35 | | CBASIC-2 Disk Extended BASIC — Non-interactive BASIC with pseudo-code compiler and runtime interpreter. Supports full file control, chaining, integer and extended precision variables etc. £75/£10 | |
| TEX — Text formatter to create paginated, page-numbered and justified copy from source text files, directable to disk or printer £45/£10 | | COMPANY PURCHASES — Performs purchase accounting function. Controls invoices, credit & debit notes. Prints purchase ledger, aged creditors report and payment advices. Comprehensive VAT control and analysis of all purchases. Interfaces with the ADD system. Requires CBASIC-2 £425/£15 | | MICRO FOCUS | |
| DESPool — Program to permit simultaneous printing of data from disk while user executes another program from the console £30/£1 | | GENERAL ACCOUNTING — Produces Nominal Budget, Trial Balance, P/L and Balance Sheet. Define your own coding system. Interactive data entry plus optional data capture from Company Sales and Company Purchases. Requires CBASIC-2 £375/£35 | | STANDARD CIS COBOL — ANSI '74 COBOL standard compiler fully validated by U.S. Navy tests to ANSI level 1. Supports many features to level 2 including dynamic loading of COBOL modules and a full ISAM file facility. Also, program segmentation, interactive debug and powerful interactive extensions to support protected and unprotected CRT screen formatting from COBOL programs used with any dumb terminal £400/£25 | |
| MICROSOFT | | | | | |
| BASIC 80 — Disk Extended BASIC Interpreter Version 5, ANSI compatible with long variable names, WHILE/WEND, chaining, variable length file records £155/£15 | | STOCK CONTROL — Maintains stock records, monitors stock levels to ensure optimum stock holding. Details include stock desc., product code, unit, unit price, quantity on hand on order/minimum. Stock analysis reports can be weekly, monthly, quarterly etc. Interfaces with Order Entry Invoicing system. Requires CBASIC-2 £325/£35 | | FORMS 2 — CRT screen editor. Automatically creates a query and update program of indexed files using CRT protected and unprotected screen formats. Output is COBOL data descriptions for copying into CIS COBOL programs. No programming experience needed. Output program directly compiled by CIS COBOL (standard) £100/£12 | |
| BASIC Compiler — Language compatible with Version 5 Microsoft interpreter and 3-10 times faster execution. Produces standard Microsoft relocatable binary output. Includes Macro-80. Also linkable to FORTRAN-80 or COBOL-80 code modules £195/£15 | | ORDER ENTRY & INVOICING — Performs order entry and invoicing function. Handles invoices for services and consumable items, part orders and part quantities. Sales Analysis report shows sales movements and trends for user-defined period. Interfaces with Stock Control, ADD and Company Sales systems. Requires CBASIC-2 £325/£35 | | APL/V80 — Concise and powerful language for application software development. Complex programming problems are reduced to simple expressions in APL. Features include up to 27K active workspace, shared variables, arrays of up to 8 dimensions, disk workspace and copy object library. The system also supports auxiliary processors for interfacing I/O ports. Requires 48K CP/M and serial APL printing terminal or CRT £70/£20 | |
| FORTRAN-80 — ANSI '66 (except for COMPLEX) plus many extensions. Includes relocatable object compiler, linking loader, library with manager. Also includes MACRO-80 (see below) £205/£15 | | ADD — Complete control of all your names & addresses including suppliers, clients, enquiries etc. Assign your own coding system and select all output via the report generator. Will print anything from mailing labels to directories. Requires CBASIC-2 £225/£35 | | PASCALUM — Compiler generates P code from extended language implementation of standard PASCAL. Supports overlay structure through additional procedure calls and the SEGMENT procedure type. Provides convenient string handling capability with the added variable type STRING. Untyped files allow memory image I/O. Requires 56K CP/M £195/£20 | |
| COBOL 80 — ANSI '74 Relocatable object output. Format same as FORTRAN-80 and MACRO-80 modules. Complete ISAM. Interactive ACCEPT DISPLAY, COPY, EXTEND £325/£15 | | Time Recording System — Provides comprehensive control over manhour expenditures by job or account. Expense details can also be controlled. Up to 75 activities can be assigned and reports produced weekly/monthly showing movements and job account totals to date. Requires CBASIC-2 £375/£35 | | PASCAL/Z — Z80 native code PASCAL compiler. Produces optimised portable reentrant code. All interfacing to CP/M is through the support library. The package includes compiler companion macro assembler and source for the library. Requires 56K and Z80 CPU. Version 3 includes all of Jensen/Wirth £205/£15 | |
| MACRO 80 — 8080/Z80 Macro Assembler. Intel and Zilog mnemonics supported. Relocatable linkable output. Loader, Library Manager and Cross Reference List utilities included £75/£10 | | Lease Rental & HP System — Designed to control agreements and contracts that are payable at regular intervals by fixed amounts. Handles lease, rental, HP or maintenance agreements with payments by invoice, SO, or cash. Can be used with ADD and CSS for complete credit control system. Requires CBASIC-2 £550/£30 | | PASCAL/MT — Subset of standard PASCAL. Generates ROMable 8080 machine code. Symbolic debugger included. Supports interrupt procedures, CP/M file I/O and assembly language interface. Real variables can be BCD, software floating point, or AMD 9511 hardware floating point. Version 3 includes Sets, Enumeration and Record data types. Manual explains BASIC to PASCAL conversion. Source for the run time package requires MAC (See under Digital Research). Requires 32K. £135/£20 | |
| XMACRO-86 — 8086 cross assembler. All Macro and utility features of MACRO-80 package. Mnemonics slightly modified from Intel ASM86. Compatibility data sheet available. £155/£15 | | Also available in bundles, contact us for details. | | | |
| EDIT 80 — Very fast random access text editor for text with or without line numbers. Global and intra-line commands supported. File compare utility included £45/£10 | | | | | |
| EIDOS SYSTEMS | | | | | |
| KBASIC — Microsoft Disk Extended BASIC version 4.51 integrated with KISS Multi-Keyed Index Sequential and Direct Access file management as 9 additional BASIC commands. KISS included as relocatable modules linkable to FORTRAN-80, COBOL-80, and BASIC COMPILER. Specify CP/M version 1.4 or 2.x when ordering. Requires 48K CP/M £295/£25
To licensed users of Microsoft BASIC-80 (MBASIC) £215/£25 | | | | | |
| MICROPRO | | | | | |
| SUPER-SORT I — Sort, merge, extract utility as absolute executable program or linkable module in Microsoft format. Sorts fixed or variable records with data in binary, BCD, Packed Decimal, EBCDIC, ASCII, floating, fixed point, exponential, field justified, etc. Even variable number of fields per record! £125/£15 | | | | | |
| SUPER-SORT II — Above available as absolute program only £105/£15 | | | | | |
| SUPER-SORT III — As II without SELECT/EXCLUDE £75/£15 | | | | | |

Software for most popular 8080/Z80 computer disk systems including NORTH STAR HORIZON, VECTOR MZ, OHIO SCIENTIFIC, SUPERBRAIN, Z80 APPLE, CROMEMCO, PROCESSOR TECHNOLOGY, RAIR BLACK BOX, DYNABYTE, SD SYSTEMS, RESEARCH MACHINES, ALTAIR, EXIDY SORCERER, IMSAI, HEATH, and 8" IBM formats

- Software with Manual / Manual Alone
- **BDS C COMPILER** — Supports most major features of language, including Structures, Arrays, Pointers, recursive function evaluation, linkable with library to 8080 binary output. Lacks data initialization, long & float type and static & register class specifiers. Documentation includes "C" Programming Language book by Kernighan & Ritchie £60/£10
 - **WHITESMITHS' C COMPILER** — The ultimate in systems software tools. Produces faster code than Pascal with more extensive facilities. Conforms to the full UNIX Version 7 C language, described by Kernighan and Ritchie, and makes available over 75 functions for performing I/O, string manipulation and storage allocation. Compiler output in A-Natural source. Supplied with A-Natural. Requires 60K CP/M £325/£20
 - **ALGOL 60 Compiler** — Powerful block-structured language featuring economical run time dynamic allocation of memory. Very compact (24K total RAM) system implementing almost all Algol 60 report features plus many powerful extensions including string handling, direct disk address I/O etc. Requires Z80 CPU £110/£12
 - **Z80 Development Package** — Consists of (1) disk file line editor, with global inter and intra-line facilities; (2) Z80 relocating assembler, Zilog Mostek mnemonics, conditional assembly and cross reference table capabilities; (3) linking loader producing absolute Intel hex disk file for CP/M LOAD, DDT or SID facilities £50/£12
 - **ZDT** — Z80 Debugger to trace, break and examine registers with standard Zilog/Mostek mnemonic disassembly displays. Facilities similar to DDT £20 when ordered with Z80 Development Package £30/£7
 - **DISTEL** — Disk based disassembler to Intel 8080 or TDL/Xitan Z80 source code, listing and cross reference files. Intel or TDL Xitan pseudo ops optional. Runs on 8080. £35/£7
 - **DISILOG** — As Distel to Zilog Mostek mnemonic files. Runs on Z80 only £35/£7
 - **TEXTWRITER III** — Text formatter to justify and paginate letters and other documents. Special features include insertion of text during execution from other disk files or console, permitting recipe documents to be created from linked fragments on other files. Has facilities for sorted index, table of contents and footnote insertion. Ideal for contracts manuals, etc. £75/£3
 - **DATEBOOK** — Program to manage time just like an office appointment book but using the speed and memory of a computer. Keeps track of three appointment schedules (three dental chairs, three attorneys, etc.) at once. Appointments consist of name, reason for the appointment, the date and time, and the length of the appointment. System can be quickly customized for the individual user. Many helpful features for making, changing, finding, and reporting appointments. Requires 48K CP/M and 180K bytes diskette storage. Not available for Apple CP/M £185/£15
 - **POSTMASTER** — A comprehensive package for mail list maintenance that is completely menu driven. Features included keyed record extraction and label production. A form letter program is included which provides neat letters on single sheet or continuous forms. Compatible with NAD files. Requires CBASIC-2 £85/£10
 - **XASM-68** — Non-macro cross-assembler with nested conditionals and full range of pseudo operations. Assembles from standard Motorola MC6800 mnemonics to intel hex £115/£15
 - **XASM-65** — As XASM-68 for MOS Technology MCS-6500 series mnemonics £115/£15
 - **XASM-48** — As XASM-68 for Intel MCS-48 and UPI-41 families £155/£15
 - **XASM-18** — As XASM-68 for RCA 1802 £115/£15
 - **WHATSIT?** — Interactive data-base system using associative tags to retrieve information by subject. Hashing and random access used for fast response. Requires CBASIC £70/£15
 - **XYBASIC** Interactive Process Control BASIC — Full disk BASIC features plus unique commands to handle bytes, rotate and shift, and to test and set bits. Available in integer, Extended and ROMable versions. Integer Disk or Integer ROMable £165/£15 Extended Disk or Extended ROMable £215/£15
 - **SMAL/80** Structured Macro Assembly Language — Package of powerful general purpose text macro processor and SMAL structured language compiler. SMAL is an assembler language with IF-THEN-ELSE, LOOP-REPEAT-WHILE, DO-END, BEGIN-END constructs £40/£10

- Software with Manual / Manual Alone
- **SELECTOR III-C2** — Data Base Processor to create and maintain multi Key data bases. Prints formatted, sorted reports with numerical summaries or mailing labels. Comes with sample applications including Sales Activity, Inventory, Payables, Receivables, Check Register, and Client/Patient Appointments, etc. Requires CBASIC Version 2. Supplied in source code. £185/£12
 - **IBM/CPM Utility Package** — has full range of functions to create or re-name an IBM 3741 volume, display directory information and edit the data set contents. Provides full file transfer facilities between 3741 volume data sets and CP/M files £125/£7
 - **BASIC UTILITY DISK** — Consists of (1) CRUNCH-14 Compacting utility to reduce the size and increase the speed of programs in Microsoft Basic and TRS-80 Basic. (2) DPFLUN — Double precision subroutines for computing nineteen transcendental functions including square root, natural log, log base 10, sin, arc sin, hyperbolic sin, hyperbolic arc sin, etc. Furnished in source on diskette and documentation £30/£10
 - **THE STRING BIT** — Fortran character string handling. Routines to find, fill, pack, move, separate, concatenate and compare character strings. This package completely eliminates the problems associated with character string handling in FORTRAN. Supplied with source £30/£10
 - **BSTAM** — Utility to link one computer to another also equipped with BSTAM. Allows file transfers at full data speed (no conversion to hex), with CRC block control check for very reliable error detection and automatic retry. We use it! It's great! Full wildcard expansions to send *.COM, etc. 9600 baud with wire, 300 baud with phone connection. Both ends used one. Standard and M versions can talk to one another £75/£5
 - **BSTMS** — Intelligent terminal program for CP/M systems. Permits communication between micros and mainframes. Sends character data files to remote computers under complete control. System can record character data sent from remote computer systems and data banks. Includes programs to EXPAND and COMPRESS binary files for transmission. This software requires a knowledge of assembler language for installation. £115/£10
 - **PLINK*** — Two pass disk-to-disk linkage editor/loader which can produce re-entrant, ROMable code. Can link programs that are larger than available memory for expansion targeted on another machine. Full library capabilities. Input can be PSA Relocatable Binary Module, TDL Object Module or Microsoft REL files. Output can be a COM file, Intel hex file, TDL Object Module or PSA Relocatable file. £70/£15
 - **RECLAIM** — A utility to validate media under CP/M. Programs tests a diskette or hard diskette or hard disk surface for errors, reserving the imperfections to invisible files, and permitting continued usage of the remainder. Essential for any hard disk. Requires CP/M version 2. £40/£5

- Software with Manual / Manual Alone
- **STRING/80** — Character string handling plus routines for direct CP/M BDOS calls from FORTRAN and other compatible Microsoft languages. The string library contains routines that enable programmes to change a COM file, retrieve command line parameters, and search file directories with full wildcard facilities. Supplied as linkable modules in Microsoft format. £50/£12
 - **STRING/80** source code available separately £185/£12
 - **VSORT** — Versatile sort/merge system for fixed length records with fixed or variable length fields. VSORT can be used as a stand-alone package or linked and called as a subroutine from CBASIC-2. When used as a subroutine VSORT maximizes the use of buffer space by saving the TPA on disk and restoring it on completion of sorting. Records may be up to 255 bytes long with a maximum of 5 fields. Upper/lower case translation and numeric fields supported. £105/£15
 - **CBS** — Configurable Business System is a comprehensive set of programmes for defining custom data files and application systems without using programming language such as BASIC, FORTRAN, etc. Multiple key fields for each data file are supported. Set-up program optimizes system to user's CRT and printer. Provides fast and easy interactive data entry and retrieval with transaction processing. Report generator program does complex calculations with stored and derived data, record selection with multiple criteria, and custom formats. Sample Inventory and mailing list system included. No support language required £185/£20
 - **MAGIC WAND*** — Word processing system with simple, easy to use full screen text editor and powerful print processor. Editor has all standard editing functions including text insert and delete, global search and replace, block move and library files for boiler plate text. Print processor formatting commands include automatic margin, indentation, heading & footings, centred and justified text. Also prints with true proportional spacing, merges with data files for automatic form letters, and performs run-time conditional testing for varied output. Requires 32K CP/M and CRT terminal with addressable cursor. £185/£20
 - **TIMAKER** — Powerful new tool for preparing management reports with tabular data. Makes financial modeling projects easy. Do you want a weekly profitability report? Set up the table and compute. Just change the sales figures for next week and compute. You have a new report! TIMAKER includes a full screen editor for setting up tables which pages left, right, up and down. Compute includes standard arithmetic, percents, exponents, common transcendental functions, averages, maxima, minima, projections, etc. Requires 48K CP/M and CBASIC-2. £155/£15



Orders must specify disk type and format, e.g. North Star-Horizon single density.

Add 15% VAT to orders. Add £1 per item postage and packing

All orders must be prepaid. Make cheques POs etc payable to Lifeboat Associates.

Manual costs are deductible from subsequent software purchase

EFFECTIVE JANUARY 1981

*CP/M is a trademark of Digital Research
 **Z80 is a trademark of Zilog Inc.

The Software Super-market is a trademark of Lifeboat Associates.

CP/M and MP/M are trademarks of Digital Research
 Z80 is a trademark of Zilog, Inc.
 UNIX is a trademark of Bell Laboratories.
 WHATSIT? is a trademark of Computer Headware.
 Electric Pencil is a trademark of Michael Shrayer Software.
 TRS 80 is a trademark of Tandy Corp.
 Pascal/M is a trademark of Sorcim.
 Soft Card is a trademark of Microsoft.
 Apple is a trademark of Apple Computer.
 PLINK, is a trademark of Phoenix Software Associates Ltd.
 MAGIC WAND is a trademark of Small Business Application, Inc.

Ⓜ Modified version available for use with CP/M as implemented on Heat and TRS-80 Model 1 computers.

Ⓛ User license agreement for this product must be signed and returned Lifeboat Associates before shipment may be made.

Lifeboat Associates
 P.O. Box 125 London WC2H 9LU
 01-836 9028/9

• Circle No. 109



PROGRAMMED FOR FUN

The Sharp MZ-80K personal computer can handle serious business as well as the next microcomputer. But it can also be programmed for fun.

This masterpiece of low-cost, easy-to-use, micro-processor technology takes over where TV games end, becoming a sophisticated source of endless hours of family entertainment. And for youngsters, of course, it has added educational value, providing a very useful introduction to the computerised world in which they will live and work.

A comprehensive catalogue of fascinating computer games is now available for use with the MZ-80K: races, battles, quiz games, exploration, showjumping, space adventures; trials of skill and concentration, pitting players against each other or against the computer. Exciting, entertaining, educational, and with such variety of appeal that the incentive to play is never dulled.

The versatile tabletop MZ-80K – and the whole range of cassette-based games – is marketed by HB Computers Ltd, Sharp's appointed software supplier for the UK. Ring or write NOW for an MZ-80K demonstration and/or your free copy of the HB catalogue of computer programmes.

SHARP MZ-80K Personal Computer with built-in cassette drive unit ONLY £380

COMPUTER GAMES
Cassette-based for use with MZ-80K £5 to £12 (see catalogue)

From the leading SHARP micro-computer supplier

HB COMPUTERS LTD
22 Newland Street,
Kettering,
Northamptonshire
Telephone
0536 520910

• Circle No. 110





**CRYSTAL ELECTRONICS
CC ELECTRONICS**

SHARP MZ80K

**For the latest competitive
PRICE**

Contact us

Before you accept discounts elsewhere.

GIVE US A TRY

**CRYSTAL ELECTRONICS is the home of XTAL BASIC
ACCLAIMED BY MANY**

We KNOW the SHARP computers, we BACK the SHARP computers
What we give FREE is worth more than money.

**MZ80K owners — are you XTAL followers?
NO! Then please read on.**

XTAL BASIC (SHARP)

Takes 5K less memory, has all the features of SHARP BASIC PLUS Multi dim strings, error trapping, logical operators, machine code monitor, more flexible peripheral handling, improved screen control, increased list control, auto run, if.. then.. else — and it doesn't stop there — it grows. You can extend the commands and functions at will — 10K, 12K, 16K, BASIC?

SHARP to XTAL BASIC conversion program is included.
£40 plus VAT (Disc version on its way)

**DESIGNERS OF MICROCOMPUTER SYSTEMS + XTAL BASIC
IS WORTH CONSIDERING ON COST ALONE.**

Members of Computer Retailers Association & Apple Dealers Association

Shop open 0930-1730 except Saturday & Sunday

40 Magdalene Road, Torquay, Devon, England. Tel: 0803 22699

Telex 42507 XTAL G

Access and Barclaycard welcome.



COMPUTERS
AND
COMPONENTS



• Circle No. 111



SSI Wargames — a real challenge.

Strategic Simulations Inc. range of Wargames — games that aren't "played out" after a few goes!

BISMARCK — May 1941, North Atlantic, SINK THE BISMARCK! Apple Graphics, full British fleet and aircraft, one or two players, highly realistic simulation.

NAPOLEON — 1813, Waterloo, the Grand Army must concentrate on beating Wellington before his Prussian allies arrive.

AMBUSH — Simulates World War II, man to man combat. Available direct (add £1.00 p+p) or through your Apple Dealer. £29.99 + VAT each, or £79.99 + VAT for all three.

(Special Offers available for bona fide wargame societies). **VISICALC DESK TOP/PLAN**, CCA Data Manager. Three packages from Personal Software Inc that every Apple should have. CCA is the best Apple Data Manager we've looked at — even interfaces to VISICALC. — drop in for a demo.

FINANCIAL CONTROLLER — Systematics Pascal (= FAST) Integrated Business System for Apple now on demonstration.

U-MICROCOMPUTERS

U-Microcomputers Limited,
Winstanley Industrial Estate,
Long Lane,
WARRINGTON,
Cheshire WA2 8PR.
Tel: 0925-54117/8
Telex: 627342



• Circle No. 112

Z89.



**Altogether
a better
computer.**

All the power and built-in peripherals for business and educational computing in one compact, desk top unit.

The Z89 Series Microcomputer.

Designed and built to the highest specification, the Z89 combines reliability and efficiency with ease of operation. And is backed, of course, by our excellent after sales service.

Features include:

- Z80 CPU
- Built-in floppy Disc with optional dual external drives
- Built-in Z19 VDU
- Up to 65K RAM
- Three serial RS-232 I/O
- Operating systems C/PM & H.DOS.
- Languages: M-Basic, C-Basic, Fortran, Pascal, etc.

And with generous OEM discounts available you can see why the Z89 is a better computer.

**Zenith
data
systems**



For full details about the Z89, complete this coupon and return it to:

Zenith Data Systems Division, Heath Electronics (UK) Ltd.,
Dept. (PC11), Bristol Road, Gloucester, GL2 6EE.

Name _____

Company _____

Address _____

Z89

• Circle No. 113

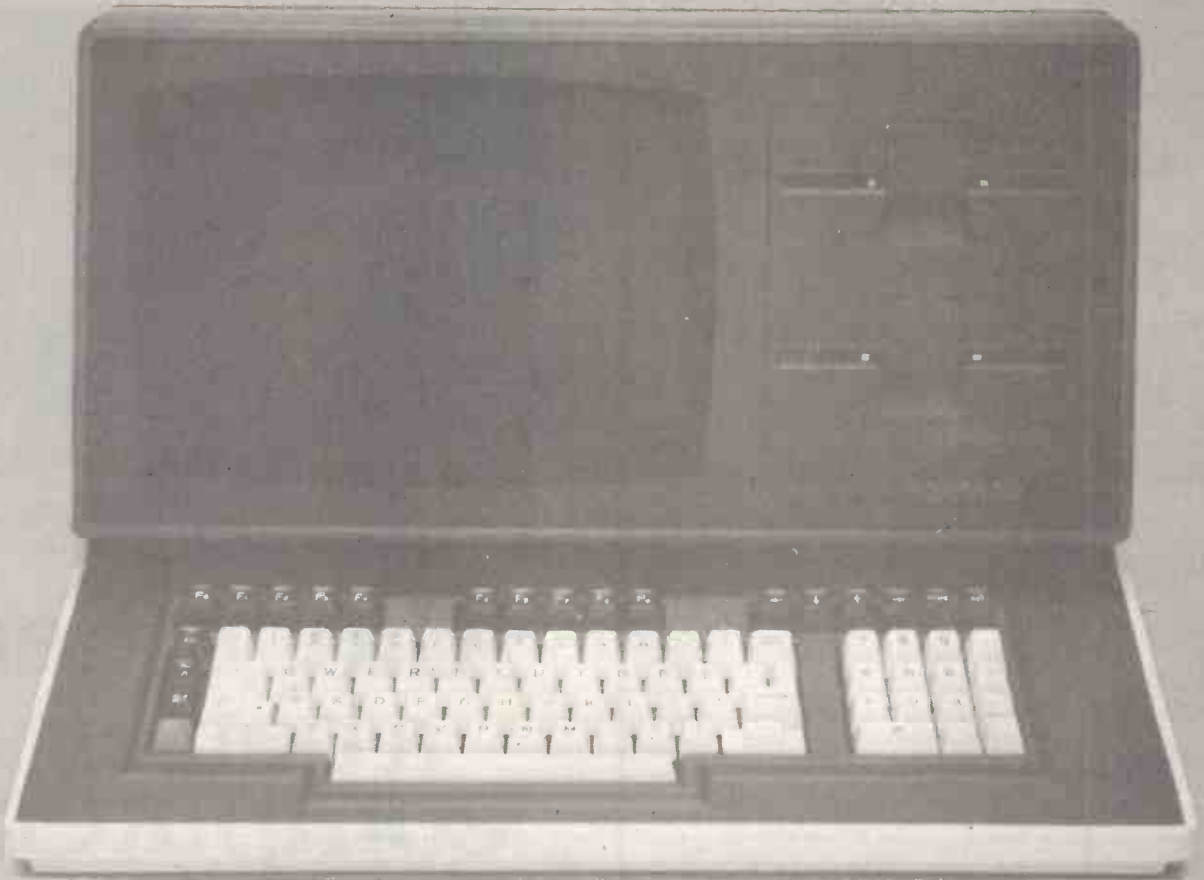

GIANTKILLER

System 10 is a new fully-integrated and highly flexible business computer which will provoke some major reappraisals of current standards of price, performance and value for money.

It is compact, reliable, portable and easy to use.

It compares favourably in price, specification and performance with a lot of well-known names and is very much more versatile.

GIANT KILLING PERFORMANCE!

For the technically minded, the main features of System 10 include:

- Z80 CPU 4MHz
- 65K RAM Standard
- 700K Mass Storage on Dual Minifloppys
- Hard Disk Interface – Additional Mass Storage
- Choice of Disk Operating Systems – CP/M – PASCAL
- 2 RS232 Serial Ports (ie Printer and Modem)
- 1 RS449 Serial Communication Port
- 1EEE 488 GPIB Parallel I/O (optional)
- High Speed Arithmetic Processor (optional)
- PROM Resident Disk Boot and Diagnostic Monitor
- Extensive Software Support Available
 - Fortran – Basic – Pascal – Cobol
- **£2995.00 (EXCL. VAT)**

INPUT OUTPUT PANEL

Flexibility and convenience is built in.



For those more interested in applications than technical jargon System 10 will do everything most small businesses need from a computer, including word processing, accounting, stock control and payroll, with readily available software. The Mainframe communication package makes System 10 an ideal smart terminal for Mainframe pre-processing and data entry.

System 10 – a brilliant new computer from Millbank.

Showroom & Offices:
98 Lower Richmond Road
London SW15
Telephone: 01-788 1083

**MILLBANK
COMPUTERS**

Service Department:
East Lane
Kingston upon Thames, Surrey
Telephone: 01-549 7262

• Circle No. 114

Enter the Computer Age video genie system

12K MICROSOFT BASIC
16K RAM, TV MODULATOR
INTERNAL CASSETTE



£330
+ VAT

£395
+ VAT

80 Columns
70 Lines per minute
Graphics Characters
Interfaces to most
machines Tractor or
friction feed



100's of programs available
TRS-80 level II software
compatible

Eley Electronics
100/104 Beatrice Rd
(Off Fosse Road North)
Leicester
Tel: 871522

• Circle No. 115

Da Vinci Computer Shop

65, High Street, Edgware, Middx HA8 7DD.

Open

Mon-Fri 9-5:30
Sat 9:30-5:30

Tel 01-952 0526

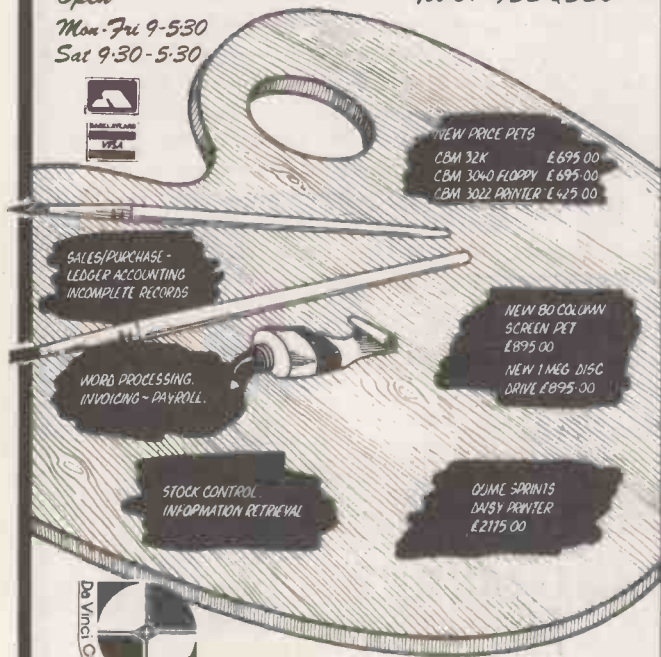

NEW PRICE PETS

CBM 32K £695.00
CBM 3040 FLOPPY £695.00
CBM 3022 PRINTER £425.00

NEW 80 COLUMN
SCREEN PET
£895.00

NEW 1MEG DISC
DRIVE £895.00

SALES/PURCHASE -
LEDGER ACCOUNTING
INCOMPLETE RECORDS

WORD PROCESSING
INVOICING - PAYROLL

STOCK CONTROL
INFORMATION RETRIEVAL

OSIME SPRINTS
DAISY PRINTER
£2115.00



OUR SYSTEMS ARE MASTERPIECES - COME AND SEE THEM!

• Circle No. 116

Z19.



The Intelligent terminal.

The Z19 'intelligent' Video Terminal, from Zenith Data Systems, is ideal for a wide variety of high-speed data handling tasks.

Compatible for use with EIA RS-232 or 20mA current loop, it has all the capabilities and features you'd expect from a top-of-the-line peripheral.

- Z80 Microprocessor based electronics
- Special deflection system for sharp resolution
- Full editing functions, plus user-definable keys
- Reverse video by character
- 24 lines of 80 characters plus 25th user status line
- 5 x 7 Dot matrix (upper case)
5 x 9 Dot matrix (lower case)
- 128 characters (95 ASCII and 33 Graphic)
- ANSI and DEC VT 52 compatible

And there's one feature of the Z19 you wouldn't expect. The price. Just £735, exclusive of VAT and delivery charges.

Generous OEM discounts are available.

Zenith
data
systems



For full details about the Z19, complete this coupon and return it to:

Zenith Data Systems Division, Heath Electronics (UK) Ltd.,
Dept. (PC1), Bristol Road, Gloucester, GL2 6EE.

Name _____

Company _____

Address _____

Z19

• Circle No. 117

INNOVATIVE

TRS-80 SOFTWARE

FROM THE PROFESSIONALS



**Animation
Animation
Animation**

Animate is a machine language program representing an entirely new breakthrough in the use of graphics on the TRS-80 or Video Genie microcomputers. As Walt Disney and others found to their profit some years ago, if you draw a number of separate pictures slightly different to each other, and then display them consecutively sufficiently fast, a moving picture is produced. This is precisely what Animate does. Pictures are built up as a sequence of frames, each one being as small or as large as you wish and composed using an easily used graphics cursor. The entire graphics content of a frame can be shifted in any direction so as to move objects without the need to redraw them in each new position. As each new frame is completed it is automatically stored in memory and given a number, so that it may be recalled and edited at will. The timing of the projection of each frame is definable up to a maximum of 100 seconds. When the picture is completed it may be viewed and edited as you wish. When the final picture is complete it may be stored on cassette as a SYSTEM program. Thereafter it may be loaded and accessed either by Animate or by any Basic program. Thus the same picture may be used in any number of different Basic programs, if you wish. Animate is available at present only on cassette for Level II or Genie machines of 16K and up. A disk version will be available shortly. A comprehensive manual is included.

£ 14.95

Plus VAT and 75p P & P = £17.94.

Send large SAE (38p) for our current Catalogue of TRS-80 software. Add £1.85 for a binder.



A.J.HARDING (MOLIMERX)

MOLIMERX LTD.

28 COLLINGTON AVENUE, BEXHILL-ON-SEA, E.SUSSEX.

TEL: (0424) 220391

TELEX 86736 SOTEX G



• Circle No. 118

PRACTICAL COMPUTING January 1981

**THE
PAPER
SHACK**

SUPPORTS PAPER USERS

With sensible prices..

RULED
14½" x 11" = **£6.00**
INC. P & P

PLAIN
9½" x 11" = **£6.00**
INC. P & P

For sensible minimums..

of 500 sheets continuous stationery.
Details of other sizes, self adhesive
labels etc:-



01-642 8971

Prices include VAT



• Circle No. 119

S 100

Do You Have All These Facilities On Your
S100 System, With Just Two Boards?

1. Z80A CPU-2 or 4 MHz Operation.
2. Z80A CTC- 4 Channels.
3. Z80A SIO- 2 RS-232.
4. Z80A PIO
5. Disk controller; Takes upto 4 disk drives, single or double density operation.
6. 64k Bytes of memory.
7. EPROM Programmer.
8. Real time clock.
9. Software;
Standard 2k Monitor.
CP/M Cold Start Loader.
CP/M BIOS (1.4)

Prices:

FDC-1 Board	£495.50
Expandomam	£327.56
Mother Board	£ 42.00

All prices exclude VAT.

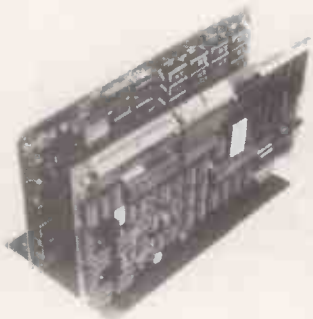

SEMEL

MICROCOMPUTER - HARDWARE - SOFTWARE

3c, BARLEY MARKET ST., TAVISTOCK,
DEVON, PL19 0JF.

Tel. TAVISTOCK (0822) 5247

Telex: 45263

• Circle No. 120

WH14.



First in line.

If you're looking for an above average line printer at a lower than average price then the WH14 from Zenith Data Systems is your first choice.

Microprocessor controlled, this compact table-top unit can be used with most computers through a standard serial interface. It provides hard-copy output of your programmes as you execute them, plus handy copies of address lines, lists and other programming data for educational or business applications.

Features include:

- 5 x 7 Dot matrix printing
- Clear easy-to-read images
- Upper and lower case characters
- Operator/software selectable line width: 132, 96 and 80 characters per line.
- Sprocket paper feed with adjustable spacing
- Stepper motor feeds allows 6 or 8 lines per inch vertical.
- Form feed operator/computer control
- Microprocessor based electronics

And at £510, exclusive of VAT and delivery charges, the WH14 puts economy first in line too.

Generous OEM discounts are available.

**Zenith
data
systems**



For full details of the WH14, complete this coupon and return it to:

Zenith Data Systems Division, Heath Electronics (UK) Ltd.,
Dept. (PC1), Bristol Road, Gloucester, GL2 6EE.

Name _____

Company _____

Address _____

WH14

• Circle No. 121



TRS-80 OWNERS!



LEVEL II CASSETTE

GAMES

Adventures:-	
Adventureland*	£9.50
Pirates Cove*	£9.50
Mission Impossible*	£9.50
The Count*	£9.50
Voodoo Castle*	£9.50
Strange Odyssey*	£9.50
Mystery Fun House*	£9.50
Pyramid of Doom*	£9.50
Ghost Town*	£9.50
Adventure Sampler*	£6.50
Air Raid*	£8.50
Air Traffic Control	£6.50
Alien Invaders	£8.50
Android NIM	£9.50
Backgammon	£6.50
Balloon Race	£6.50
Barricade*	£8.50
Baseball	£8.50
Battleship	£7.50
Bee Wary	£9.50
Bingo	£4.50
Bowling (Ten Pin)	£8.50
Bridge Challenger	£9.50
Challenge	£6.50
Cribbage	£6.50
Dogstar	£6.50
End Zone II	£6.50
Fastgammon*	£12.00
Galactic Blockade	£6.50
Galactic Empire	£9.50
Galactic Revolution	£9.50
Galactic Trader	£9.50
Game of Life*	£6.50
Gammon Challenger*	£9.50
Hangster	£5.50
Hangman	£4.50
I Ching	£6.50
Invaders from Space*	£9.50
Kamikaze	£6.50
Kreispiegel II	£9.50
Lost Dutchmans Gold	£6.50
Mastermind II*	£5.50
Mean Checkers*	£6.50
Noughts & Crosses	£4.50
Othello III	£6.50
Pentominoes	£6.50

MODEL I

Pinball*	£9.50
Pork Barrel	£6.50
Pre School Games	£6.50
PR Dogfight	£6.50
Robots	£4.50
Round The Horn	£6.50
Safari	£6.50
Santa Paravia	£6.50
Sargon II*	£18.50
Space Battles	£9.50
Star Trek III.5	£9.50
Taipan	£6.50
Time Trek*	£9.50
Ting Tong*	£6.50
Trek '80	£6.50
Trolls Gold	£4.50
Tycoon	£5.50
Warfare I	£5.50
X-Wing Fighter II	£6.50
UTILITIES	
APL-80*	£9.50
Accounts REC II	£13.50
Appointment Log	£6.50
Astronomy II	£7.50
Basic IP*	£11.50
Basic Toolkit*	£11.50
Biorythms	£4.50
Calendar Functions	£7.50
Copys	£9.50
Data Base II	£17.50
Dosort*	£12.50
Electric Pencil*	£50.00
Electronics Asst.	£6.50
EMU 6502	£16.00
ESP Tester	£4.50
File Handling	£7.50
Finance I	£7.50
Finance II	£7.50
Forth (Incl. Primer)	£37.50
Fourier Transforms	£7.50
Graph Builder	£9.50
G.S.F.*	£17.50
General Accounting	£8.50
Ham Radio	£6.50
Histogram/Scattergram	£6.50
Home Finance	£6.50
Infinite Basic*	£31.00
Infinite Business*	£18.50
Inst. Calculator	£7.50
Inventory 'S'	£16.00

Inventory Control	£11.00
IQ Builder (Vocab)	£9.50
IQ Builder (Spelling)	£10.00
IQ Builder (Stories)	£9.50
IQ Builder (Pre School)	£9.50
IQ Builder (Numbers)	£9.50
IRV*	£16.50
Keyboard 80*	£7.50
KVP*	£9.50
Level III Basic*	£30.00
Linear Programming	£7.50
Magic Paper Calculator	£9.50
Math Drill	£5.00
Math Library I	£8.50
Math Library II	£8.50
Medump*	£8.50
Microtext Editor	£6.50
Minicrossword	£9.50
Mortgage Calculator	£5.00
Multi-Choice	£9.50
Pascal*	£26.00
Penmod*	£11.50
Personal Finance	£6.50
Personal X-REF	£9.50
Pilot 2.2*	£9.50
Pre Flight	£11.00
Renumber*	£6.50
Remodel+Proload*	£23.00
RPN Calculator	£6.50
RSM 2 Monitor*	£15.50
Statistics	£6.50
S.T.A.D.*	£16.00
Star Finder	£7.50
Super Simon	£6.50
Super T-legs*	£6.50
T-Step*	£7.50
System Copy*	£8.50
Timer	£9.50
T-Short*	£6.50
T-Short+*	£12.50
Tarot Cards	£6.50
Teachers Assistant I	£9.50
Teachers Assistant II	£9.50
Tiny Comp*	£12.50
TRS-80 Opera	£6.50
Typing Tutor	£11.50
X-ref	£9.50
Yybar	£9.50
76 Basic Programs	£23.00
Manual for Above	£7.00
Library 100	£40.00

DISK

A.P.L. 80*	£30.00
Accounts Receivable II	£40.00
Advanced Personal	
Finance	£15.50
Amateur Radio System	£15.50
Auto Disk Directory	£9.50
C.C.A. Data Management	£52.50
Compress It	£15.00
Data Base III	£30.00
DCV-1	£8.50
Dynamic Data Base	£22.50
Electric Pencil*	£75.00
File Manager 80	£30.00
Forth* (Incl. Primer)	£45.00
General Ledger II	£40.00
Inventory 'S'	£40.00
Inventory II	£50.00
KVP Extender*	£16.00
Level I in Level II*	£16.00
Mailist IV	£45.00
Newdos Plus*	£47.50
Newdos 80*	£87.50
Payroll (Tridata)	£249.00
Print Spooler*	£16.50
Roots	£14.50
RSM 2D Monitor*	£16.00
Simplify-It	£15.00
SCRIPSIT*	£65.00
SUPERSCRIPT*	£17.50
ST-80D* Terminal	£45.00
ST-80 III* Terminal	£85.00
Visicalc*	£65.00
Taranto & Associates Conversion of Osbourne & Associates Business Programmes	
Accounts Payable	£90.00
Cash Journal (for G/L)	£40.00
Invoicing	£90.00
Accounts Receivable	£90.00
General Ledger	£90.00
Complete Co-ordinated System with Manuals	£350.00
*Denotes Machine Language	
TRS-80 Trademark of Tandy Corp. CP/M Trademark of Digital Res. C-Basic Trademark of Compiler Systems.	

MODEL II

CPM 2.2X	£165.00
CBasic 2 (CP/M)	£80.00
Postmaster (CP/M)	£85.00
Supersort III (CP/M)	£80.00
RSM II	£35.00
T/Maker (CP/M)	£175.00
DSM II	£87.50
GSF II	£30.00
Development System	£70.00
Utility Package	£87.50
Basic X-ref Utility	£30.00
Hard Disk Operating Sys.	£250.00
WORD PROCESSORS	
Electric Pencil II (CP/M)	£200.00
Electric Pencil II TRSDOS	£225.00
Magic Wand (CP/M)	£230.00
Wordstar (CP/M)	£275.00
BUSINESS SYSTEMS	
Osbourne & Associates Programmes in CBasic:-	
Accounts Rec & Payable	£150.00
General Ledger	£150.00
In TRSDOS:-	
Accounts Rec & Payable	£200.00
General Ledger	£200.00
CP/M USERS GROUP	
23 Volumes	Each £12.00
ALL PRICES INCLUDE VAT AT 15%. PACKING & RETURN POSTAGE TO U.K. ADDRESSES. PRICES TO OVERSEAS ADDRESSES INCLUDE RETURN AIRMAIL. SEND 50p FOR DESCRIPTIVE CATALOGUE.	



MICROCOMPUTER APPLICATIONS
11 RIVERSIDE COURT,
CAVERSHAM,
READING RG4 8AL,
ENGLAND.
TEL: (0734) 470425

KNIGHT'S T.V. & COMPUTERS

SHARP'S BIG DEALER



Dear Microfans,

Because we sell more Sharp products than any computer dealer we can offer a package deal on the MZ-80K which is unbeatable. The 24K model costs £439, the 36K is £469 and the full 48K model is £499. These prices include next day Red Star delivery, 100 programmes, one year's complete guarantee, and membership of The International Sharp User Group (send £3 to join if you bought your Sharp elsewhere).

We will also send you our exclusive "KNIGHT - COMMANDER" which adds AUTO LINE NUMBER, RENUMBER, DELETE BLOCK, PRINT/SCREEN, APPEND, AND TRACE commands to the Sharp Basic without taking any extra memory space. Write, phone or telex, and we will mail you full details of our exclusive package deal. We take Access, Barclay, VISA and Mastercharge, but remember to add Maggie's VAT.

Happy computing.
Graham Knight

PS Special Offers on Sharp disks and printers. Input/output boards £45 ex stock. Our latest Newsletter details CP/M for the MZ80K and previews the £2,995 Super-Sharp.

KNIGHTS TV AND COMPUTERS

108 ROSEMOUNT PLACE, ABERDEEN.
TEL: (0224) 630526. TELEX: 739169.

• Circle No. 122

CASTLE ELECTRONICS MICRO COMPUTER CENTRE

Now out of twelve years' experience in electronics and communication comes the South Coast's own Computer Centre. Choose from our wide range of micro-computers and support material. Ideally suited to the hobbyist about to enter the fascinating world of computers. Personal callers or mail order welcome.

NASCOM

Nascom 2—£225. Comprehensive starter system that grows with you. Powerful Z80A. 57 KeyLicon solid-state keyboard. TV or monitor. On board UART (6402). Parallel 1/0 with 16 lines. Kit fully documented. 8K microsoft basic in ROM.

Nascom Imp—£325. Plain paper with standard specification. Features: 60 lines/minute. Bidirectional printing. Baud rate 110-9600.

Nascom 1—£125 Kitform —£140 readybuilt. Full range of Nascom accessories are normally held in stock. Detailed specification and full list available.



£125

TANGERINE

Microtan 65—£69 6502 microprocessor. 1K Tanbug. 1K user RAM. Full TV display. 20-way keypad £10.

Tanex—£43 7K RAM, 6K RAM, 8K. microsoft basic. 32 parallel 1/0 lines. 2 serial. 1 x 20mA serial.

Cassette interface and motherboard. System Rack —£49 in black/tangerine brushed aluminium. Full Ascii keyboard with numeric keypad £56.35 Cabinet available at £20 Optional lower case pack—£9.48 Chunky Graphics Pack—£6.52

£69

COMMODORE PET

Everything has been said about PET. A full range of accessories and software (both games and business) is held in stock.

8K Small Keyboard: £399.00
8K Large Keyboard: £425.00
16K: £499.00
External Cassette: £55.00

£399



Apple 16K video output only—£895.00. Disc drive without controller—£299.00. Disc drive with controller—£349.00. 16K add-on—£69.00.

CARDS: Prototype/hobby card—£15.00. Parallel Printer Interface Card—£104.00. Communications Card—£130.00. High-speed serial Interface Card—£113.00. Pascal Language System—£299.00.

Epson T80 Printer: £349.00

+ FREE £695
32K RAM

SHARP

MZ80—Sharp's dynamic entry into microcomputers. Floppy disc units plus printer now available.

Dual Discs: £715.00
Printer: £475.00

£449



video genie system

Easy-to-use BASIC language means that programmes are easily written for specific applications. Many pre-recorded programme tapes are available. TRS80 software compatible. Great scope for the home, introducing the whole family to the computer age.

9" Monitor only £85.00
Epson 80 Printer £349.00

£299

SALE OF DEMONSTRATION EQUIPMENT

Centronics 779 with stand was £995.00 now £699.00 Computhink 800K Dual Disc was £1145.00 now £895.00 32K PET was £695.00 now £599.00 16K Apple 11 was £695.00 now £599.00 All items sold with warranty.

BOOKS

Basic Computer Game—£5.50. Instant Basic—£7.20. Pet Revealed—£10.00 Library of Pet Subroutines—£10.00. Your First Computer—£5.95. Guide to Basic Programming—£8.85. Basic Basic—£6.50. Advanced Basic—£6.00. Programming Z80—£8.95. 6520 Applications Book—£7.95. And lots more. Send for full list of microcomputer and electronics books.

Send for free brochures and price list

Media C12 Cassettes—£5.00 for 10. 10 x 5 1/4" mini floppy discs—£25.00 Kybe or Memorex. Listing paper—£15 per box, 2000 sheets 11 x 9 1/2".

Printers: Commodore 3022, Epson 80, Anadex DP8000, Qume. Service: Full service and spares for all equipment. Microprocessor components 6502, Z80A, 2716, 2114, etc., etc. Large range of CMOS, TTL, Linear, Transistors, Capacitors, Sockets, Rectifiers, LEDs, Resistors—full list available. Monitors: Range of direct import U.S. monitors 12" b/w £139.95. 12" green/black £149.95. Hitachi 12" £187, 9" £127. Under development—IEEE Intelligent Interface for Nascom, IEEE Controller, to operate Nascom or Commodore discs. Delivery January 1981.

ALL PRICES—ADD 15% VAT. DELIVERY: POSTAGE/PACKING WILL BE NOTIFIED
BARCLAYCARD AND ACCESS ORDERS TAKEN BY PHONE

CASTLE ELECTRONICS

7 CASTLE ST., HASTINGS, EAST SUSSEX TN34 3DY
Shop hours 0900 to 1730 Mondays to Saturdays

Telephone: Hastings (0424) 437875
Personal callers welcome

• Circle No. 123

MONITORS MONITORS MONITORS



9 inch standard
Now Only
£69.50
Plus VAT and P&P.

UNCASED 9"

UNCASED 12"

CASED 9"

CASED 10"

CASED 12"

MONITOR TUBES

SELF CONTAINED MONITOR PCB's

All monitors available with
P4, P31, P36 tubes.

CROFTON ELECTRONICS

Crofton Electronics Limited
35 Grosvenor Road, Twickenham, Middlesex.
Tel: 01 891 1513

• Circle No. 124

Research Resources Ltd

SWTP and GIMIX 6809

- * RRL specialises in the EDUCATIONAL and SCIENTIFIC applications.
- * Small systems from 32k with 5" disk drives upwards.
- * PASCAL, FORTRAN, PILOT, BASIC. Compiler, LAB-BASIC, Statistical Analysis etc.
- * D-A, A-D converters and special interfaces to solve your problem.

UNIX on a MICRO

- * The new standard DEC/PDP operating system is now available on 6809 micros.
- * UNIFLEX is a MULTI-USER/MULTI-TASKING system for up to 12 users.
- * RRL provide the complete system with from 128k to 768k RAM.
- * 2.5 Megabyte floppy disk drives and 16 Megabyte fixed disks.
- * Full range of VDU's, terminals, printers, interfaces etc.

RESEARCH RESOURCES LTD, P.O. Box 160
Welwyn Garden City, Herts. England
Tel: (07073) 26633

• Circle No. 125

Z — EIGHTIES

BELTA SYSTEMS/TERODEC

- BUSINESS SYSTEMS
- FULL 64K
- Z80 S100 CP/M MP/M
- SINGLE OR MULTIUSER
- NETWORK SYSTEM IMMINENT
- HARD DISCS FLOPPY OR MINI FLOPPY DISCS
- PRICES FROM **£3100**

TOOLKIT FOR SORCERER!!

Now available — loads from cassette and runs as an extension to the normal BASIC to give: —

- Screen editor: just move the cursor to any line on the screen and insert, delete or amend!
- LIST a,b : lists programme from line a to line b.
- LIST a, : lists from a to end.
- LIST b, : lists from start to b.
- KILL a,b : delete from line a to line b (also KILL a, and KILL b,).
- RENUMBER programme lines.
- OLD command recovers old programme after NEW, CLOAD or RESET.
- RANDOMIZE: starts off random number series differently each time.
- AUTO automatically numbers programme lines for you.
- LINK joins BASIC programmes together.
- FIND searches your programme for a specified string of characters.
- STEP causes programme execution one line at a time.

* Many other useful features to give your Sorcerer everything you could wish.

* Runs on 16,32 or 48K machines.
Price of £30.00 + V.A.T. + 50p p&p (£35.00 total) and includes on years membership of SPEC (Sorcerer Programme Exchange Club) — existing members may deduct £5.009.

RICOH RP-1600

DAISYWHEEL PRINTER
FOR FAST HIGH QUALITY WORK
IDEAL FOR WORD PROCESSING
MICROLINE — 80

NEW LOW PRICE

£399

BUSINESS SOFTWARE

CHOICE OF LEDGER AND WORD PROCESSING PACKAGES TO RUN ON MANY MACHINES. REQUIRE CD/M. INTERFACES LEDGERS FROM £295 OSBORNE LEDGERS FROM £150 GRAHAM DORIAN LEDGERS FROM £150 SEND FOR DETAILS OF OTHER PACKAGES

EXIDY

- * A SMALL BUSINESS MACHINE AT A PERSONAL PRICE
- * HIGHLY VERSATILE FOR APPLICATION IN EDUCATIONAL & SCIENTIFIC TASKS
- * UNIQUE DESIGN FEATURES
- * Z80 — S100 — CP/M
- * EXCEPTIONAL WORD PROCESSING CAPABILITY
- (OUR MACHINES WORK FOR US 24 HRS. A DAY AT THE HEART OF A SUCCESSFUL WORD PROCESSING BUREAU)
- * FOR SOMETHING SPECIAL — SORCERER

QUALITY SOFTWARE

new! GRAPHICS ANIMATION by Lee Anders. This package provides the BASIC programmer with a powerful set of commands for graphics and animation. The program is written in machine language but is loaded together with your BASIC program and graphics definitions with a CLOAD command. Any image from a character to a large graphic shape may be plotted, moved, or erased with simple BASIC commands. Encounters of plotted character sets with background characters are detected and background images are preserved. Contains a medium resolution plotting routine. A keyboard routine detects key presses without carriage returns. Includes a separate program for constructing images. Runs on any size Sorcerer. **£17.00**

QS SMART TERMINAL by Bob Pierce. Convert your Sorcerer to a smart terminal. Used with a modem, this program provides the capability for you to communicate efficiently and save connect time with larger computers and other micro-computers. The program formats incoming data from time-sharing systems such as The Source for the Sorcerer video. Incoming data can be stored (downloaded) into a file in RAM. Files, including programs, may be saved to or loaded from cassette, listed on the video, transmitted out through your modem, or edited with an on-board text editor. Interfaces with BASIC and the Word Processor Pac. **£30.00**

MARTIAN INVADERS	£12
FORTH	£30
SHAPEMAKER	£12
SOFTWARE MANUAL	£10

BASIC COMPUTING

251 BRADFORD RD, KEIGHLEY
W. YORKS BD21 4DG.
Tel: 0535 63145

MICROPUTE

9 PRESTBURY ROAD
MACCLESFIELD, CHES. SK10 1AU
TELE: 0625 612759

• Circle No. 126

Coming shortly models 82 & 83



Oki Microline 80

THE WORKHORSE MICRO PRINTER
- Small, light, quiet matrix printer.

- * 40, 80, or 132 cols. * 6 or 8 lines per inch
- * 96 ASCII + 64 graphics character set with Centronics compatible interface * 9x7 matrix
- * 80 chs. per sec. * 200 x 10⁶ head warranty
- * No duty cycle limitation * Double width characters * Friction and Pin Feed * Rugged business use - metal chassis - two motors

Now ONLY £349 + VAT RS232 option available

Compukit UK101 DISC DRIVES

with up to 32k RAM exp



free games disc

- * 9 Digit extended Basic
- * Plugs straight into 8k Compukit requires no hardware mods. (5v.5A required for 610)
- 610 Expansion (8k) ONLY £159 + VAT
- Disc Drive with DOS ONLY £285 + VAT

EXATRON Stringy Floppy

COMBINES ECONOMY OF CASSETTE WITH SPEED & RELIABILITY OF DISC

16k loads in approx. 24 secs. - Wafers to 75ft (48k approx.)



PET ONLY	TRS 80 ONLY	APPLE ONLY
£199	£188	£199
+ VAT	+ VAT	+ VAT

Stringy Floppy with 10 Wafers (Tapes) BUS EX. 2 for 1. Machine Lang. Monitor

Base 2 MODEL 800MST



Now ONLY
800 MST £295 + VAT
850 MST £375 + VAT

80 COLUMN HIGH PERFORMANCE IMPACT PRINTER - suitable for most Micros.
JUST LOOK AT THESE STANDARD FEATURES:-

- * RS-232, 20mA, IEEE 488 and Centronics I/O
- * 15 Baud rates to 9,600 * 100 Chrs. per second - Bidirectional * 6 print densities 60, 72, 80, 96, 120 or 132 Chr/line * Self test switch * 96 Chrs. ASCII Standard * Auxilliary User Defined Ch. set * Tractor and fast paper feed/graphics
- * 2k Buffer * Accepts 8 1/2" max. paper pressure feed and 9 1/2" max. paper tractor feed.
- Model 850 - utilises Fifo, 125cps.

Anacom 150

150 CPS, 15" carriage dot matrix printer

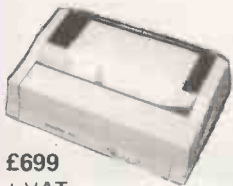

£699 + VAT

* 150 chs per sec * 9 x 9 dot matrix * 70 chs per inch horizontal * 6 or 8 chs vertical * 136 columns, 13.6" line length * 94 ASCII chs * Upper and lower case with decs. * Logic seeking * Centronics and/or RS232

NEVER KNOWINGLY UNDERSOLD

WE WILL MATCH OR BEAT ANY PRICE CURRENTLY ADVERTISED FOR THESE PRODUCTS

Excel Discs

10 x 5 1/2" ONLY £18.50 + VAT

WITH HUB RING



+ FREE LIBRARY CASE

Epson MX 80 - COMPLETE RANGE OF INTERFACES TANDY, SHARPE, PET, APPLE, etc.

- * 9x9 dot matrix * Logic Seeking * Bi-directional
- * 96 ASCII Characters * 64 Graphics and 8 International Characters * Centronics I/P with optional RS232 and IEEE 488 * Four print densities 40, 80, 66 or 132 columns * Multiple type fonts * Self Test * Self Diagnostics * Buzzer for end of paper and bell code error

Now ONLY £359 + VAT

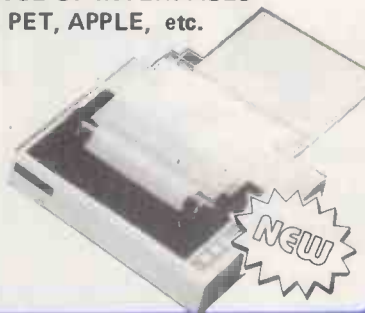

NEC Spinwriter

- for the professional word processing system

£1390 + VAT



Model 5510 - RS232, Model 5530 Centronics 8bit par. NEC's high quality printer uses a print "thimble" that has less diam. and inertia than a daisy wheel. Giving a quieter, faster more reliable printer that can cope with plotting and printing (128 ASCII chs.) with up to 5 copies, friction or tractor fed. 55Chrs/sec.

Dip 81 FULL 80 COLUMN IMPACT PRINTER



100 characters per second, bidirectional, low profile, ideal for hobby or educational. at ONLY £249 + VAT

Ohio Superboard III & Challenger IP Series 2

- the no fuss start to Micro's.

* Ready Built 8k Microsoft in ROM, 6 digit floating point basic plus full features. 4k RAM - expandable to 32k.

SUPERBOARD III (24x24 format) £159 + VAT
or switchable to 48 x 12
POWER SUPPLY 5v, 3A . . . £27 + VAT
CASE £29 + VAT
CHALLENGER 1P Series 2 . . . £219 + VAT
(Superboard is used in Challenger)



Micro Peripherals
(MITRECREST LIMITED)

formerly Mighty Micro

FULL SERVICE BACKUP - FULL DETAILS ON REQUEST INCLUDING PRINTOUT
Please add VAT @ 15%. Carriage extra, will advise at time of order. Official orders welcome

61 NEW MARKET SQUARE, BASINGSTOKE, HAMPSHIRE

Telephone: Basingstoke (0256) 56468 and 56417 (4 lines)

Buy in confidence. If on receipt of your order the goods do not meet with your satisfaction, return within 7 days for full refund. Credit facilities arranged.
DISCOUNTS: Attractive quantity discounts for OEM, Educational & Dealers also in association with O.S.I. Computers, Esher, Surrey. Telephone: 0372 62071



SPELING MITSAKES?

CORRECTOR is the world's first program for micros to detect and correct spelling mistakes.

- 25,000 word dictionary from Oxford University Press
- Space for 20,000 user-definable words — good for industries or sciences with a technical vocabulary
- CORRECTOR needs Z80 and at least 130K on disk CP/M — and a text editor
- Send SAE for brochure, £150 for disc and manual.
- Coming soon version for Apple II with Z80 Card.

SOUTHDATA LTD
221 Portobello Road,
London W11

• Circle No. 128

THE ONE STOP COMPUTER SHOP

**BUSS
STOP**

We Supply Systems for Business, Education and Industry —
And We Support Them With Service and Software!

Commodore					
2001-8	£379.00	8032	£895.00	KIM1	£93.00
3008	£398.00	8050	£895.00	KIM3B	£96.95
3016	£495.00	8024	£1160.00	KIM4	£65.00
3032	£625.00	8010	£220.00	Toolkit, SuperChip,	
3022	£383.00	Pet Lead	p18.75	Soundbox, Parallel	
3023	£337.00	IEEE Lead	£23.44	and Serial Interfuses	
3040	£625.00	C2N Cass	£49.50	All Ex-Stock.	

Now on demonstration — The NEW PET MODEM, with Supporting Software.

VIDEO GENIE — EG3003 16K RAM, 12K LEVEL II BASIC IN ROM.
TRS80 Compatible **£289.50**

NASCOM — Phone for latest Details/Prices.

Dolphin Printers — The Superb BD80P now 80/132, chrs/line.
Down to **£450.00** While Stocks Last.

The New BD136, The Ultimate Intelligent Matrix Printer — Prints
at 240 Chrs/Sec. **£1200.00**

RICOH, QUME, NEC Spinwriter etc, Also Available, Please phone
for Prices.

CONSUMABLES C15's Only £4.00 for 10. 10 Verbatim 5¼" Disks
— 35 Track £19.95 — for CBM 3040. 10 Verbatim 5¼" Disks —
77 Track £36.50 — for CBM 8050.

Wide range of Continuous Stationary in stock — Paper, Labels etc.

SOFTWARE — We Sell Only The Best — Wordpro, Wordcraft,
OZZ, Communicator, Medicom — and much more! Plus — A Wide
Range of Books and Manuals for all Machines.

Please phone for carriage charges, all prices + VAT
Photo Acoustics Ltd, BUSS STOP Computer Division
255a St. Albans Road, Watford, Herts. (entrance in Judge Street)
Phone: Watford 40698 or Newport Pagnell 610625

• Circle No. 129

RING FALKIRK [0324] 22766 NOW!

for further information

**WE SELL: ANADEN PRINTERS (8000 - 9500 SERIES),
TELETYPE RANGE M43, M40, LEAR SIEGLER V.D.U.'s,
80 COLUMN CARD PUNCHES Plus MEDIA**

WE SERVICE: ALL THE ABOVE EQUIPMENT
Plus A SELECTION OF MICROPROCESSOR EQUIPMENT, RANGE
OF PAPER TAPE, KEY-CASSETTE AND KEY-DISC DEVICES.
WE HAVE OUR SCOTTISH SALES AND SERVICE NETWORK
BASED IN FALKIRK

WE ARE A U.K. COMPANY WITH 110 SERVICE ENGINEERS
NATIONWIDE

KSL KODE SERVICES LTD

CRAWFORD CHAMBERS, CALLENDAR RD. FALKIRK TEL. 22766 TELEX 449335

• Circle No. 130

COMPUTERS IN STORE.

SUPPLIES FOR YOUR COMPUTER

The cheapest available? Judge for yourself, but remember that all prices are inclusive of VAT and postage:

Listing paper 11" x 14.5"		
1-part	per 1000	£9.50
2-part	per 500	£11.00
3-part	per 500	£15.00
Plain White Listing, 12" x 9.5"		
1-part	per 2000	£23.00
Continuous White Envelopes, 10" x 4.5"	per 1000	£52.00
Diskettes 8", soft sector double density	each	£2.50
	per 10	£24.00
As above, double side		
	each	£3.80
	per 10	£36.00
Diskettes 5.25", soft sector double density	each	£3.40
	per 10	£32.50
As above, double side		
	each	£4.70
	per 10	£43.50

All diskettes are top quality Wabash products, and remember prices include VAT and postage. All other sizes and specifications available — please phone for price.

SHARP Pocket Computer

1.9K memory, with Basic interpreter	£109.25
Cassette interface for the above	£21.56

Forms Handling Equipment

'Swingline' table-top burster	£684.25
'Swingline' table-top decollater	£404.80

VIDEO GENIE COMPUTER SYSTEM

SHARP M (20K version)	£379.50
	£575.00

PEACHTREE SOFTWARE FOR 'SUPERBRAIN'

Packages, ready to work, for Purchase Ledger, Sales Ledger, General Ledger (which can all be integrated) and Inventory Control.

Each package distributed on one **single-sided** diskette. Excellent operating manuals (available separately). Price per package: **£340** per manual (refundable against subsequent purchase): £15. Note that MBASIC is required to operate these packages, and this will be supplied for £155.

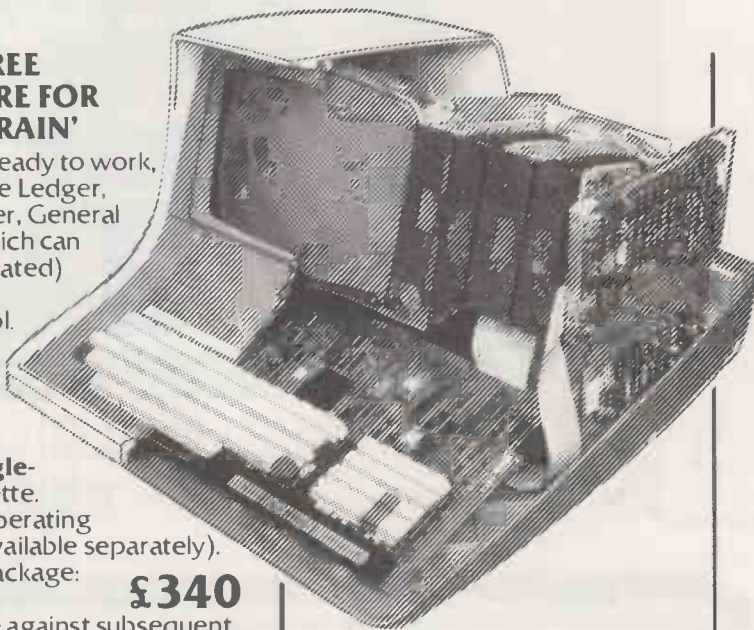

SHARP CALCULATORS (a selection from our wide range):

EL8152 Ultra-thin (weighs only 36g)	£22.58
EL8154 miniature, elegant and fashionable styling	£19.91
Financial Calculator, for Banking, Investments, Marketing, Amortisation etc.	£55.44
Language Translator, with 152 sentences and between 1800 and 2000 words. English to either German, French, Japanese (Roman and Katakana) and Spanish,	£104.00
Language Modules for the above	£25.00

Please phone for prices of others in the range.

GAMES

Chess Champion	£55.00
Boris Diplomat	£95.50
Challenger 7	£90.50
Sensory '8'	£130.50
Atari TV Games Unit	£107.00
Cartridges for the above	from £17.25

ORDERING INFORMATION

All prices are inclusive of VAT and postage. Red Star service can be provided at extra cost. Telephone or write, quoting Access or Barclaycard number, and goods will be immediately despatched. Personal callers welcome from 9 am to 5.30 pm Mon-Fri, 9 am to 1 pm Saturday.



**ELECTRONIC SYSTEMS
& COMPUTERS**

74 WATERLOO ST, GLASGOW G2
TEL. 041-221 0310

• Circle No. 131

INTERFACE YOUR PET TO THE OUTSIDE WORLD

WITH OUR
MULTI-PURPOSE IEEE/488 BUS, TALKER/LISTENER
BOARD 32 I/P:32 O/P PLUS RS 232

Applications include:-

EDUCATION/EXPERIMENT – allows Pet basic to drive L.E.D.s, switches, relays, etc.

A.T.E. (Automatic Test Equipment) – allows interface to equipment such as D.V.M.s, timers, counters, printers, etc.

Double height Eurocard (9" x 6") micro-computer board: requires 5V (1A) supply – ($\pm 12V$ - RS 232 only)

BOARD PRICE: £149.50 : P.S.U./Pet harness available.

For info. contact F. Holmes **M/H/G** Leeds 589495 Ext. 294

• Circle No. 132

aculab

floppy tape,

The tape that behaves like a disc,
For TRS-80 LEVEL II and Video Genie.

Connects directly to TRS-80 Level 2 Keyboard. Operating and file handling software in ROM. 8 commands add 12 powerful functions to Level 2 BASIC. No buttons, switches or volume controls. Full control of all functions from Keyboard or program. Daisy chain multiple drives. Certified digital tape in endless loop cartridges. Reads and writes in FM format at 9000 Baud. Soft sectored with parity and checksum error detection for highly reliable operation—just like discs. Maintains directory with up to 32 files on each tape, tapes may be write-protected. Supports Basic and machine-language program files, memory image and random access data files. 12 character filespecs—: "FILENAME/EXT:d" (d is drive no. 0-7). Automatic keyboard debounce. Full manual with programming examples and useful file-handling routines.

COMMANDS (usually followed with a filespec and possible parameter list).

@SAVE, @LOAD, @RUN —for BASIC programs, machine language programs and memory image files. @GET, @PUT —moves a 256-byte record between a random access file and BASIC's data buffer. @KILL —removes a file from the directory and releases tape sectors for immediate re-use. @LIST —displays file directory along with sector allocation and free sectors. @NEW —formats tape and creates a blank directory.

Master drive with PSU, Manual and a selection of tapes.

For TRS-80 £169-00, for Video Genie £174-00.

Slave drives £125-00. (add £2-00 p.p. + vat).

(Export orders pp charged at cost)



For further information,
Telephone
0525 371393

aculab Ltd.
24 Heath Road,
Leighton Buzzard,
Beds. LU7 8AB

• Circle No. 133

The £4,000 microcomputer that thinks it's an £8,000 microcomputer.

If you've got just £4,000 to spend on a microcomputer you've got a choice.

Either take a chance on any of the hundreds of cheap microcomputers around. And pay the price of inefficiency and unreliability.

Or buy an F.500 from Fortronic.

Based on the very latest Motorola 6809 microprocessor chip, its features include a dual processor option for system integrity, disc storage from ½ megabyte upwards and a wide range of

communications hardware and software.

Which means communications with other computers is easier than ever.

And it's both flexible and expandable, with a wide range of software available for system development.

For a computer that does all this and more, you'd expect to pay nearer £8,000 than £4,000.

You'd be wrong.

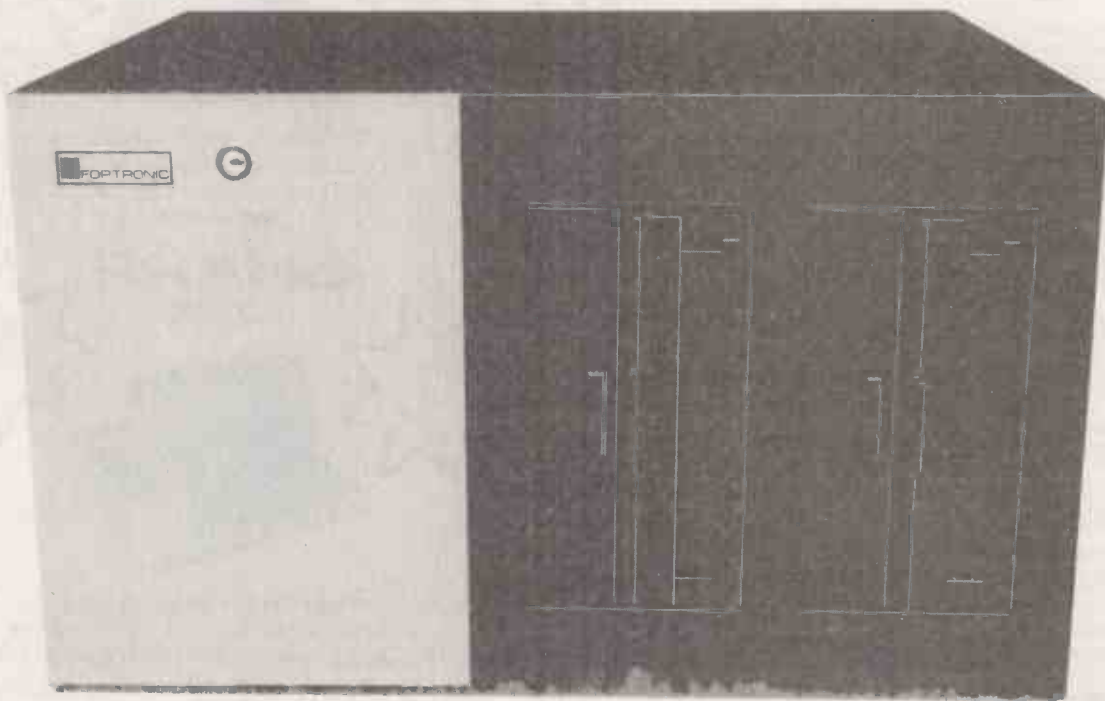

Cheap at twice the price.

 **FORTRONIC**

Holden Way, Donibristle Industrial Estate, Dunfermline, Fife KY11 5JW.
Phone: Dalgety Bay (0383) 823121. Telex: 727438.

London Office: Fortronic Ltd., Royal Mint Level, Europe House, World Trade Centre, East Smithfield, London E1 9AA. Phone: 01-488 2909 Telex: 884671

• Circle No. 134

BITS & P.C.S.

COMPUTER PRODUCTS LTD

4 Westgate, Wetherby, West Yorks, LS22 4LL
Telephone (0937) 63744

THE NORTH'S LEADING NASCOM SPECIALIST



HIGH RESOLUTION GRAPHICS FOR NASCOM 2
8192 Programmable dots Memory mapped with demo software and free game £60.00

NEW PRODUCTS FOR NASCOM:

DISCS:
Single drive £390.00
Double drive with CPM & EBASIC £640.00
Ask for details
Professional designed for your NASCOM

KENILWORTH CASE
A high quality case made from stelvete coated steel and solid mahogany £49.50
Mounting Kit for two cards T.B.A.
Mounting Kit for five cards £19.00

SARGON CHESS PACK
This pack includes the book and a tape with Sargon prepared to run under NAS-SYS. Also included in a special graphics rom and a PCB giving your NASCOM the ability to switch between two graphics ROMs, your original and the chess ROM. All the above for only £35.00

INTERFACE EPROM BOARD
Provides sockets for both 2708 and 2716 EPROMs (up to 16 EPROMs) and also provides a fully decoded socket for the NASCOM 8K BASIC ROM. This board is produced to full NASBUS specification and can be used in "page mode" together with the new NASCOM RAM B. Wait states may be generated on board to allow a NASCOM 1 to run at 4MHz in BASIC. The complete Kit at only £55.00

CASTLE INTERFACE
Gives the following features: — Auto tape drive * Auto cassette muting * Auto serial printer muting * 2400/1200/300 BAUD cassette. This interface built and tested complete with documentation at only £17.50

ASTEC 10" B/W MONITOR
A Professional Cased 10 inch Monitor giving superb resolution, only £99.50

ANALOGUE TO DIGITAL CONVERTER
This unit gives 4 Channels with an Input Range of 0 to 120mV up to 0 to 24V. Conversion time (average) 0.5mSec. Supplied built and tested at only £49.50

DUAL MONITOR
This Kit allows switching between two monitors on a NASCOM 1 e.g. T4 and NAS-SYS £6.50

PORT PROBE
A very useful device for testing and evaluating ports and peripheral software with improved documentation £17.50

HEX AND CONTROL KEY PADS
Our popular range of add on key boards for the NASCOM micros
HEX for NASCOM 2 £34.00
HEX & CONTROL KEYS for NASCOM 1 £40.50

CASSETTE MACHINE
Will reliably record data at 2400bd and above manufactured by SHARP £25.50

PROGRAMMERS AID
In 2 2708 EPROM gives the NASCOM ROM BASIC many extra commands: AUTO, RENU, DELE, DUMP, FIND HEX, APND, HELP ... etc. £28.00

BITS & P.C.s GAMES TAPE 1
Good value — ten excellent games £8.00

PRINTERS
We have a good range of printers all of which will work on the NASCOM, RICOH, EPSON, IMP, QUME, ANADEX

BOOKS
Full range including INMC mags

MEMORIES
4116, 4027, 2708, 2716

**BUILT SYSTEMS REPAIRS MAIL ORDER and ADVICE
are our SPECIALITY**

FULL RANGE OF NASCOM PRODUCTS

BITS & P.C.s COMPUTER PRODUCTS LTD
4 WESTGATE, WETHERBY, WEST YORKSHIRE.
TEL: 0937 63744

**SAE FOR DETAILS. PRICES EXCLUDE VAT AND
POSTAGE/PACKAGE**

• Circle No. 135

TOMORROW TODAY at Birmingham Computer Centre

Commodore official distributors



4016, 4032, 4008 PETs

The reliable value for money system with after sales support, instruction and training facilities and a wide range of programmes.



Apple authorised distributors

The sophisticated quality system with a reputation for advanced design and innovation.

SHARP Z80K



The incredible computer system now available ex-stock including the New Dual Drive Double Sided Floppy Disk.

**THE ULTIMATE IN DAISYWHEEL PRINTERS
RICOH.RP 1600**



THE BEST WORDPROCESSOR.PRINTER.AVAILABLE
DEALER ENQUIRIES WELCOME

CAMDEN ELECTRONICS MICROCOMPUTER SYSTEMS

462 COVENTRY ROAD • SMALL HEATH • BIRMINGHAM B10 0UG
Telephone: 021-773 8240 or 021-772 5718 • Telex: 335909 (Camden G)

• Circle No. 136

A Word Processor, Report Writer, Mailing System, Data Base Manager, and a Computer all for £1995*



Yes, we are offering all this with our SERIES 5000 5" floppy-disc system for the incredibly low price of £1995.*

Not only do you get a powerful Z-80A system on the S-100 bus built to high quality standards by Industrial Microsystems, one of the longest and best-established companies in the microcomputer industry, and supported by Equinox, specialists in microcomputers and multi-user systems.



You also get the popular CP/M Operating System (from Digital Research), a 12-slot bus for easy expansion, a Z-80A CPU for powerful performance, 2 serial and one parallel interfaces, 64KB of dynamic RAM with in-built error detection capability,

and dual 5" double-density drives with the option of a third drive (or quad capacity drives in place of double-density) in the same cabinet.

Additionally, there is the Turbocharger option providing both enhanced disc capacity, disc performance and diagnostics. And if even greater storage is required we can supply 8" floppy drives and cartridge disc drives.

A powerful system for the computer-user and system developer – and one with eventual access to OS/2000, the Industrial Microsystems networking system.

And for the office or business user we are including as standard a powerful Word-Processing package (Wordstar), a Mailing and Letterwriting package (Mail-Merge) and the Datastar Data Base Manager. All these packages are widely accepted and professionally written by Micropro International.

Being CP/M based, the system with suitable configuration will also run the business software developed by (for instance) Graffcom, Peachtree, Paxton, etc.

It will also run a wide range of languages – Basic, Cobol, Fortran, Pascal, APL, Algol, C.Lisp, and Forth and will support a wide range of add-on S-100 devices, such as floating point processors, Prestel interfaces, speech synthesisers, digitisers and plotters, etc.

And just to make certain that you get full use out of your system, nationwide field service support is available at a modest extra cost.

*add VAT and the terminal and printer of your choice at the costs shown.

Series 5000 with 64KB Dynamic RAM, dual 5" double density drives, CP/M Operating System, Wordstar, Mail-Merge and Datastar £1995

The same system with quad drives in place of the double density drives £2230

Add-on double density drive £290

Add-on quad drive £405

Peripherals:
Televideo 912C VDU £595

Elbit 1920X VDU with Wordstar keyboard £895

OKI Microline 80 printer £595

Texas 810 150cps printer £1450

NEC Spinwriter RO Word processing printer £1850

All prices exclude VAT, carriage, training and installation and are subject to our standard terms and conditions.

OEM dealer and educational enquiries welcome.

EQUINOX

COMPUTER SYSTEMS LIMITED

Kleeman House, 16 Anning Street,
New Inn Yard, London EC2A 3HB
Tel: 01-739 2387/9 & 01-729 4460

IF . . . you want the best service
you need professional advice
years of experience impress you
you are trying to find the best computer equipment
as well as the finest software . . .

MICROSOLVE

is the Company to contact

We cover a full range of equipment including the **APPLE II** (from £695/16K); the **MICROSTAR** multi-user system (from £4,950) and the powerful **ALPHA MICRO** which will run 1 to 22 terminals — the most cost effective system available today.

WE OFFER A COMPLETE SERVICE which encompasses advice, systems design, sale and installation of computer and peripherals, as well as tailor-made software, where necessary. There are fully documented **ACCOUNTING** and **WORD PROCESSING PACKAGES** etc., for **ACCOUNTANTS, SOLICITORS, MANUFACTURERS, RETAILERS, MEDICAL PRACTITIONERS** in fact all business applications.

ALSO in stock are **PRINTERS, VDUs, CONTINUOUS STATIONERY, DISKETTES, DISK BOXES**, all from the best names in the computer world — **TEXAS, LEAR SEIGLER, TALLY, QUME, PAPER TIGER** etc.

So if you either wish to buy a computer to program yourself or take advantages of our service — **TELEPHONE NOW FOR AN APPOINTMENT.**

MICROSOLVE COMPUTER SERVICES LTD.
3rd Flor (rear), **MIDDLESEX HOUSE**,
29-45 High Street, **EDGWARE**, Middlesex.
01-951 0218/9/0
(exit 4 M1/20 mins. West End). prices ex. VAT.

• Circle No. 138

...for ITT 2020 and Apple Computers

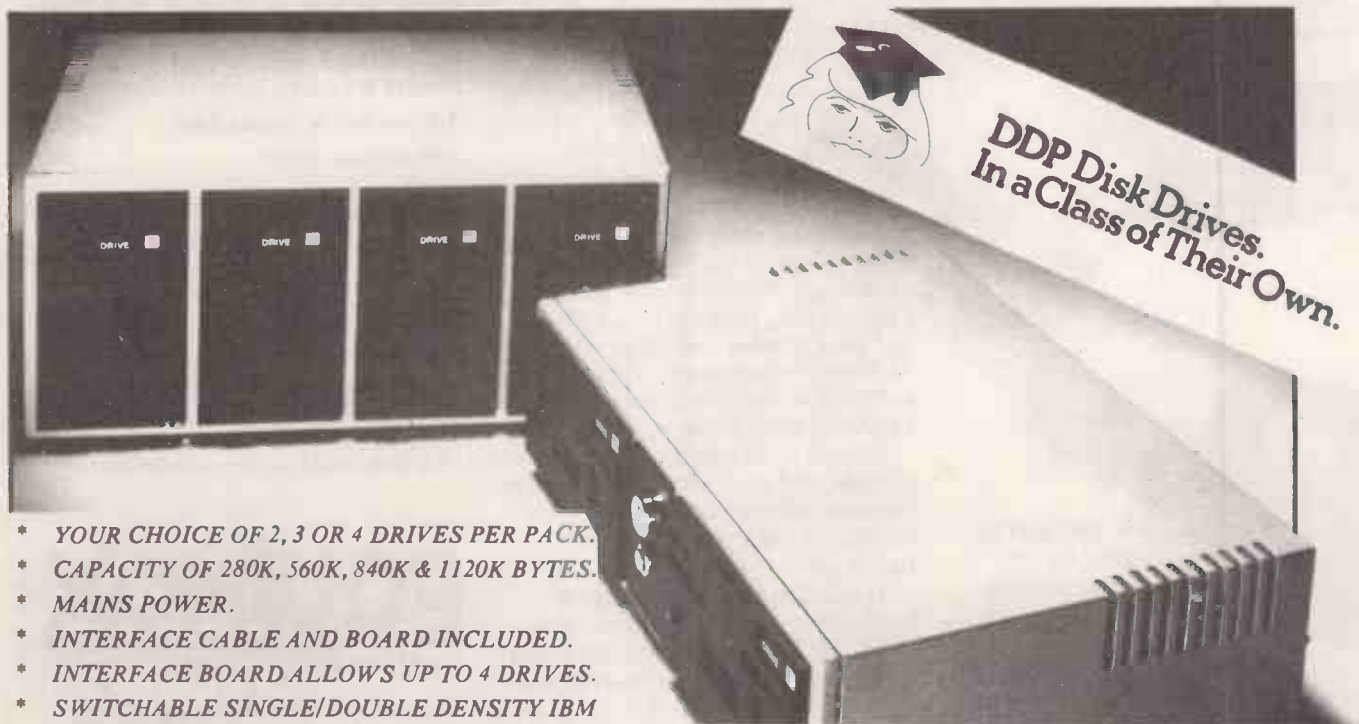

- * YOUR CHOICE OF 2, 3 OR 4 DRIVES PER PACK.
- * CAPACITY OF 280K, 560K, 840K & 1120K BYTES.
- * MAINS POWER.
- * INTERFACE CABLE AND BOARD INCLUDED.
- * INTERFACE BOARD ALLOWS UP TO 4 DRIVES.
- * SWITCHABLE SINGLE/DOUBLE DENSITY IBM 3470 FORMAT.
- * 2 & 3 PACK HAVE LOCKABLE POWER SUPPLY FOR SECURITY WITH LED POWER INDICATORS.



DISTRIBUTED DATA PROCESSING LTD.,
36 Nobel Sq., Basildon, Essex. SS13 1LT.
Tel. Basildon (0268) 728484

• Circle No. 139

SOFTWARE

Software & Manual/Manual Only

Byrom Software	BSTAM—Utility to link one microcomputer to another also using BSTAM £70/5
Computer Plus	FMS 80 (File Management System) Demo Pack (includes manual and disc) £35 Complete System £395/25
Computer Services	Bidirectional driver for Diablo Hytype printers for use on CPM & CDOS systems £65/10
CP/M User Library	42 Volumes on 8" disc £4 42 Volumes on 5" disc £8
Creative Computing	For CP/M CS-9001 BASIC Games 1 £12 CS-9002 BASIC Games 2 £12 CS-9000 BASIC Games 1 and 2 £22 CS-9003 ADVENTURE I.O. £12 CS-9004 BILINGUAL Original Adventure £12 CS-9005 BASIC Games 3 £12 CS-9006 BASIC Games 4 £12 CS-9007 BASIC Games 3 and 4 £22 CS-9008 BASIC Games 1, 2, 3 and 4 £40
Digital Research	(Most formats now available) MPM 1.1 £175/18 CP/M 1.4 £65/18 CP/M 2.2 £90/18 SID £45/12 ZSID £55/12 MAC £55/12 TEX £45/12 DESPOOL £30/5 PL/1 £POA/25
Information Unlimited	WHATSIT (Database Management System) on North Star £59 on CP/M £75 on APPLE 2:48k (requires int Basic) £72 On APPLE 2:32k (requires int Basic) £59 on ITT 2020 (see Apple)
KLH Systems	Spooler for CPM systems £65/5
L.P. Enterprises	Diablo driver runs 110 to 9600 baud with autoloader for CP/M or CDOS £30/5 OMNIX—UNIX like multiuser, multitasking operating system for Z80 i.e. IMS, Cromemco, Horizon £250/30 Multiforth £65/20
MICAH Inc.	CP/M for CDOS Users: Program to Expand CP/M system to be compatible with Cromemco CDOS software £59/5 Disc Utilities: Pack one of CDOS users includes: Fast disc copy, Track test, Disc test, Compare files and others £30/5 Pack two for CP/M users includes same as pack one £30/5 Pack three for Cromemco users includes same as pack one and spool and print £65/5
Microsoft Inc.	BASIC-80 £175/17 BASIC Compiler 5.2 £195/17 FORTRAN-80 £220/17 COBOL-80 4.0 £355/17 EDIT-80 £45/11 MACRO-80 £80/11 MICROSEED £TBA/20 MULISP £TBA/20 MUMATH £TBA/20
Michael Shrayner Inc.	Electric Pencil Word Processor £100 SSII for tty etc £100 DSII for Diablo £105 TRS-80 Cassette/disc £50
Microfocus Ltd.	CIS COBOL version 4.2 £425/25 FORMS 2 £100/10
Micropro Inc.	WORD-MASTER 1.7 £70/20 TEX-WRITER 2.6 £35/15 WORD-STAR 2.1 £240/25 SUPER-SORT: Version 1 £120/20 Version 2 £100/20 Version 3 £75/20 WORD-STAR with MAIL-MERGE 2.1 £310/25 MAIL-MERGE 2.1 £70/10 DATASTAR 1.07 £165/20
MT Microsystems	Pascal MT £125/12
Northshare	Multi-user system for Horizon Users 5.1 £40/5

Software & Manual/Manual Only

Osborne & Associates	Accounts Payable & Accounts Receivable (disc only) £50 General Ledger (disc only) £50 Payroll with Cost Accounting (disc only) £50
Compiler Systems	CBASIC v2.06 £65/15
Structured Systems all Converted to UK Standard	Sales Ledger £275/15 Purchase Ledger £275/15 Nominal Ledger £325/15 Stock Control £275/15 Letterlight £95/10 Analyst (File management Reporting System) £115/10 NAD (Name and Address selection system) £50/10 OSORT £50/10
TDL Software (Technical Design Labs)	Business Basic £80 ZTEL (Text Editing Lang.) £35 MACRO II (Z80 Macro Assembler) £35 LINKER £35 DEBUG II (for 8080/Z80) £45
Tiny-C Associates	Tiny-C language for 8080, 8085, Z80 systems £50/35
Supersoft Inc.	DIAGNOSTICS 1 £35/5 TERM £65/5
Software Works	Northstar Format only £50/10 Inventory-1 (Stock Control) £130/15 Inventory-2 with order entry, invoicing £50/15 Mailroom Housekeeper (Utilities, sorts) £35/10 Preventative Maintenance £75/15 Housekeeper-2 (Coming Soon) £TBA

ORDER INFORMATION

Software prices reflect distribution on 8" single density discs. If a format is requested which requires additional discs a surcharge of £4 per additional disc will be added.

Please add VAT and £2.50 for first class postage, packing and insurance.

If required, DATAPOST D service is available for an extra charge of £7.50.

All software on this Advertisement is available from stock and a 24-hour return service is thereby offered on all prepaid orders. When ordering CP/M software please specify the format you require otherwise software will be dispatched on an 8" single density disc.

For more information on any of these items, please phone, write or visit. (We are open during office hours).

All publications are published in the U.S.A. and are stocked in Britain by L.P. Enterprises.

We aim to keep all of these books in stock and as a result of this most mail orders are despatched by return of post.

OEM terms available

MAIL ORDER TELEPHONE ORDER VISIT

Send Cash, Cheque, Credit Card No., Postal Order, IMO to L.P. Enterprises, Room PC1, 8 Cambridge House, Cambridge Road, Barking, Essex IG11 8NT.

All Payment must be in sterling and drawn against a UK bank.

Subscriptions are processed to start with the next current issue, after the date of order.

These details are all current as of August 1980.

Prices are subject to change without notice, due to fluctuation in the dollar rate.

Trade Enquiries welcome.

Bulk Purchasers welcome.

• Circle No. 140



small systems engineering limited

2-4 Canfield Place London NW6 3BT Telephone 01-328 7145 6

IEEE-488 PET INTERFACES

B200	Bi-directional RS232C serial	£186.00
Type C	Uni-directional RS232C serial	£120.00
AP	Addressable parallel for Centronics or Anadex printers	£106.00
GPI AP	Micro based bi-directional serial interface with buffering Custom GPI software development for special interfacing requirements	£249.00

- All serial interfaces incorporate:
- Software or switched Baud rate selection with 16 different rates selectable
 - Crystal controlled Baud rate
 - Full RS232C handshake
 - 20 mA current loop i.o. capability

All the above interfaces have two modes of code conversion to match print out to the PET screen for either display mode

Non Addressable parallel	£45.00
TV/Video interface	£35.00

We also stock a range of PET connectors.

PET SOFTWARE

- TCL PASCAL BASIC COMPILER COMMUNICATOR** - Intelligent terminal package teletype, DEC VT50 emulation, runs on 80 column PETs
- VISICALC WORDCRAFT** - Word processing software for 40 and 80 column PETs

NEW . . . MUPET

Multi user disk system allows 2 to 8 PETs to be linked together to share a CBM disk unit and printer: prices from £595 for a 3 user system.

S100 HARDWARE and SOFTWARE

P&T S100 IEEE controller	£350.00
Measurement Systems dynamic memory boards	
BISYNC 80 IBM 2780/3780 emulation software	£425.00

PRINTERS PRINTERS PRINTERS

RP 1600 DAISY WHEEL
60 CPS PET, centronics, RS232 interfaces
Phone for new low price!!

ANADEx DP 9500 150-250 CPS Line Printer.	£895.00
--	---------

New . . . HEWLETT PACKARD HP-85 PERSONAL COMPUTER

For professional scientific and engineering applications.
Full range of interfaces and peripherals available.
As IEEE-488 interfacing specialists we can provide full technical support and advice on HP-85 applications.



CompUtopia LIMITED

30 Lake Street, Leighton Buzzard, Bedfordshire
Tel: (0525) 376600 24 hour Answering Service

APPLE II

from **£695**
+ VAT

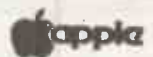

authorised dealers

- *Choice of 16K, 32K, 48K user RAM
- *Huge range of software already available.
- *Simply plugs into video monitor or UHF TV.
- *High resolution graphics (54000 point array)
- *Eight Accessory expansion slots for disks, printer etc.

commodore

authorised dealers

PET 2001

- *Choice of 8K, 16K, 32K user RAM
- *Huge range of software already available
- *Self-contained monitor
- *Numeric keypad on keyboard
- *Full expansion capability for cassette, disks and printer.



THE VIDEO GENIE SYSTEM EG 3003

- *16k User RAM plus 12k Microsoft BASIC in ROM
- *Fully TRS 80 level II software compatible
- *Huge range of software already available
- *Self contained, cassette, PSU & UHF modulator
- *Simply plugs into video monitor or UHF TV
- *Full expansion capability for discs & printer



£330 + VAT

PERIPHERALS

PRINTERS	
Texas Instruments Omni 810 Printer	£1450.00
Paper Tiger Printer with Graphics	£ 598.00
MONITORS	
VM129 Hitachi 12" B&W Video Monitor	£187.00
VM910 Hitachi 9" B&W Video Monitor	£127.00

EPSON
£395
+ VAT

£395 + VAT complete with interface for APPLE, PET or VIDEO GENIE

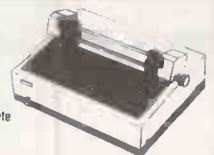

The Microsoft Z80 SoftCard opens up new horizons for your APPLE II

Plug the new Microsoft Z80 SoftCard into your APPLE II and start using *all* of the system and application software written for Z80 based computers. Included with the board is the versatile CP/M; the most widely used micro-computer operating system, and Microsoft's 5.0 BASIC, the most powerful version to date of Microsoft's famous BASIC Interpreter.

£199 + VAT

Dealer enquiries welcome.

WATCH YOUR APPLE GROW TO TWICE ITS SIZE!!

Add a twin 8" disk and give yourself up to 1.6 million characters of storage on line.
Dealer enquiries welcome.

£1280 + VAT

BASIC & BASIC PROGRAMS

Illustrating Basic Alcock	£ 3.25
Basic Handbook Lien	£11.00
Computer Programs that Work Lee/Beech/Lee	£ 3.95
Basic Computer Games Ahl	£ 4.25
More Computer Games Ahl	£ 4.25
C207 Microprocessor Interfacing Techniques	
Lesea/Zaks	£ 9.50
6502 Assembly Language Programming Leventhal	£ 7.95
C202 Programming the 6502 Zaks	£ 7.95
G402 6402 Games Book Zaks	£ 7.95
The Pet Revealed Hampshire	£10.00
Z80 Assembly Language Programming Leventhal	£ 7.95
Z80 Microcomputer Handbook Barden	£ 6.80
Introduction to Microcomputers Vol 0 Osborne	£ 5.00
Introduction to Microcomputers Vol 1 Osborne	£ 7.50
The Personal Computer Book Bradbeer	£ 5.30

BOOKS

Please phone or write for complete book list and prices.
Prices include P&P within the U.K.
Please send cheque or P.O. or if phoning your order, state Barclaycard number.

DON'T!

BE LEFT HOLDING THE BABY

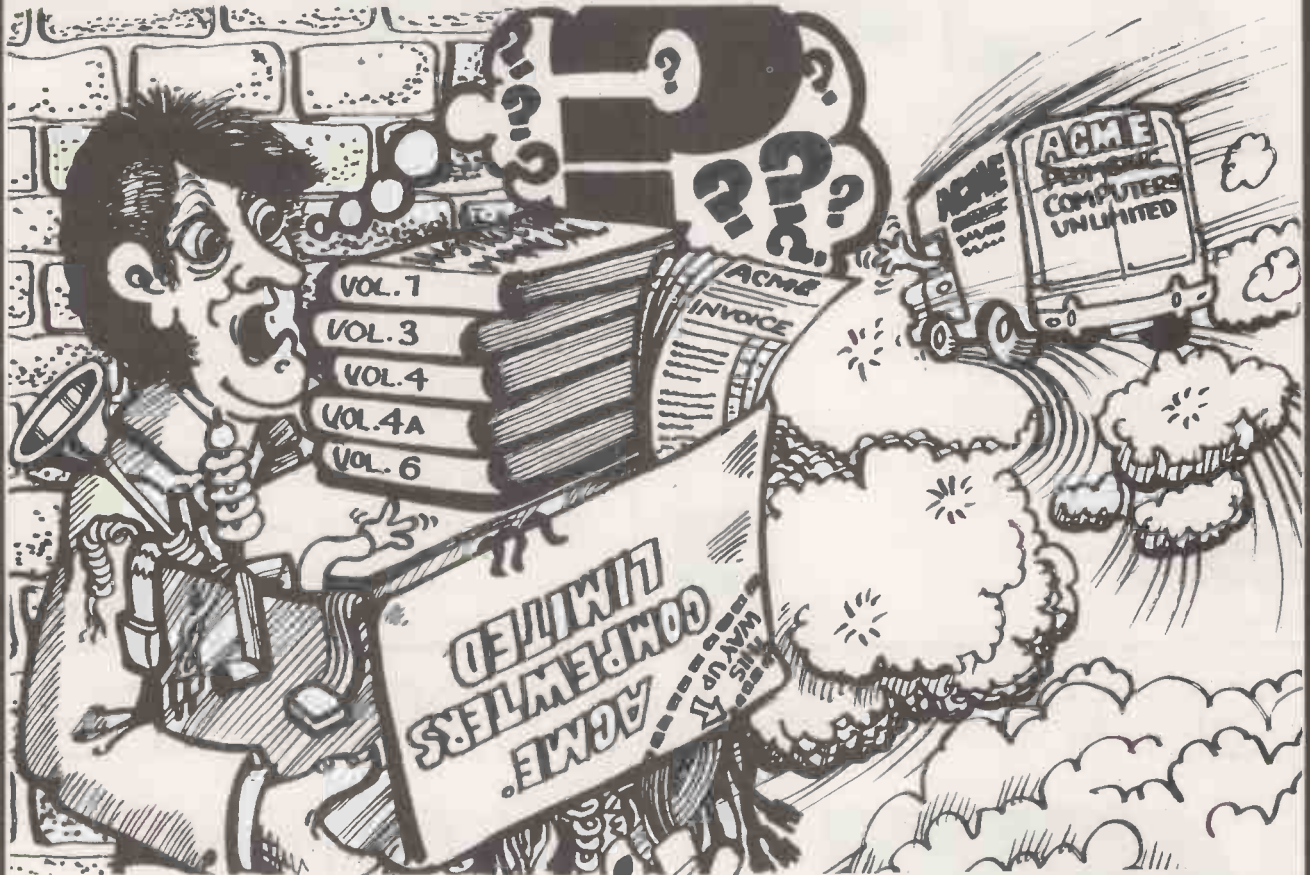

We are Stack-Apple, here to deliver complete Apple Systems for industry, higher education and the technical user. If you are trying to establish the research results, monitor the performance, or control the rig, you need reliable developed hardware plus full technical support. We can supply a wide range of Apple Interfaces, A/D, D/A, RS232, BCD, Parallel, TTL, Relay, Mains Switching. If required we can design a custom interface for you. Apple now runs more software than any other personal computer including BASIC, MBASIC, FORTRAN, PASCAL, COBOL, CORAL, CORAL, FORTH, 6502/Z-80 assembly language development systems, CP/M and CP/M compatible software. We are here to support Apple users who are trying to solve a problem. If you're looking for a system for data acquisition, process control or software development you cannot do better than Apple. If you are already using Apple we can help with interfaces, software and hardware problems. Interested? Call or post the coupon now!



**PLEASE ADD
OUR NAME
TO YOUR
MAILING LIST**

Name _____

Address _____

Telephone _____



Please send the coupon to
STACK-APPLE 290/298 DERBY ROAD, BOOTLE, LIVERPOOL.
Telephone: 051-933 5511.

PCI/81

• Circle No. 143

THE SHARP MZ-80 COMPUTER SYSTEM



As one of Sharp's largest systems dealers we supply complete MZ-80 systems including FLOPPY DISCS and PRINTERS.

We have considerable experience in implementing SALES, PURCHASE and NOMINAL LEDGERS, PAYROLL, STOCK CONTROL, FOREIGN EXCHANGE and FINANCIAL PROGRAMMES.

Contact us now for details on 01-247 8506.



Stone House, Houndsditch Entrance
128-140 Bishopsgate
London EC2M 4HX



• Circle No. 144

Erase Eproms in 8 minutes for under £100

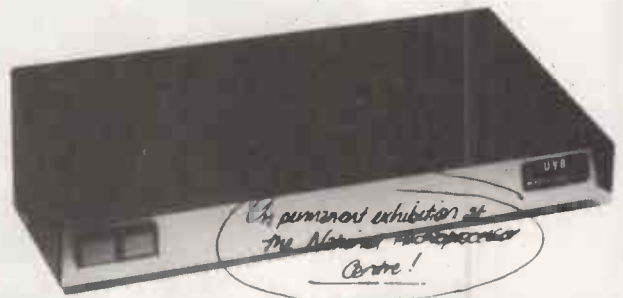

The high speed, high capacity model UV8 sets new performance and price standards.

- Cuts typical erasure times by a factor of 5
- 8 MINUTE SOLID STATE TIMER
- Capacity up to 14 EPROMS
- 2708 type erased in 4 to 7 minutes
- High intensity 254 NM UV source
- Safety interlock automatically starts timing sequence
- Audio tone signals erasure cycle complete
- Internal switch to extend erase time.

MICRODATA Computers Ltd, Belvedere Works, Bilton Way, Pump Lane Industrial Estate, Hayes, Middlesex.

Telephone (01) 848 9871 (6 lines) Telex 934110

• Circle No. 145

SHARP MZ-80K SOFTWARE



TRADE ENQUIRIES WELCOME

For Games Business Education

Send now for our
FREE CATALOGUE

MAP-2ILTO

9 Herbert Road, London N11
Tel: 01-889 7615 (24 hours)

• Circle No. 146

CP/M SOFTWARE

from

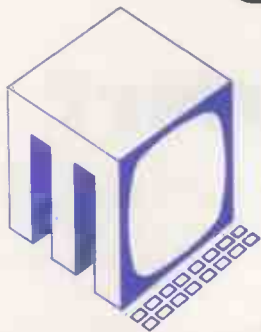

METROTECH

WORD PROCESSING

WORD-STAR^{tm1} is the most complete integrated word processing software system ever seen on a microcomputer. In less than six months more than four thousand people have proudly purchased WORD-STAR.

WORD-STAR 2.0 £255
WORD-STAR 2.0 with MAILMERGE £315

INTEGRATED BUSINESS SYSTEMS

Written specially for the U.K. market, Version 2.0 of GRAFFCOM'S Integrated Small Business Software is now available for both floppy (ISBS-F) and hard (ISBS-W) disk systems. Prices for the floppy disk systems are:—

Payroll	£475
Company Sales	£425
Company Purchases	£425
General Accounting	£375
Stock Control	£325
Order Entry and Invoicing	£325
Name & Address	£225
Time Recording	£375
Lease, Rental & HP	£375

Discount prices are quoted for bundles of the above systems. Manuals £35 each.

Prices for the hard disk systems are available on request.

LANGUAGES/UTILITIES

CBASIC II Commercial Disk Extended Basic	£ 75
SBASIC Compiler Structured Basic	£175
SUPERSORT I	£125
WORD-MASTER Superior Text Editor	£ 75
MET/TWAM Index sequential file access in CBASIC II	£ 55

All software is **Ex-stock** and available on standard 8" disks or 5" disks for Cromemco Z2H, Dynabyte North Star Horizon, Vector MZ & Superbrain.

- * Add 15% VAT
- * Postage and Packing £2 per order
- * State which disk type and size

- * All orders prepaid
- * Manuals available at £15 each except where indicated

COMMUNICATIONS

BISYNC-80/3780 and **BISYNC-80/3270** are full function IBM 2780/3780 and 3270 emulators for microcomputers. **BISYNC-80/3780** gives you a Remote Job Entry terminal for the price of a micro!

BISYNC-80/3270 combines the local processing power of a micro with a sophisticated screen capability. Make your dumb terminal smart!

I/O Master is a superb S100 buffered I/O board which supports 3780 and teletype communications, plus serial and parallel peripherals.

MET/TTY will connect your micro to a timesharing service in simple teletype emulation.

BISYNC-80/3780	£275
BISYNC-80/3270	£275
MET/TTY	£ 95
I/O Master Board	£225

DATA MANAGEMENT

SELECTOR III-C2

An easy to use Information Management System; requires CBASIC II

£185

SELECTOR IV

An advanced Information Management System; requires CBASIC II

£275

DATASTAR

Powerful data entry, retrieval and update system

£195

Micro Data Base Systems

MDBS is a full network database with many additional features.

Prices available on request.

NEW * FINANCIAL REPORTING * NEW

Have you seen and liked VISICALC^{tm2}?

Did you know that similar facilities are now available under CP/M^{tm3}?

REPORT WRITER will carry out all your calculations and produce reports with your headings, totals and summaries. Ideal for financial planning, budgeting and management reporting. Requires Microsoft Basic.

REPORT WRITER £150

GLECTOR

General ledger option to Selector III; requires Selector III and CBASIC II

£185

Telephone orders welcome for Access, Barclaycard, American Express or Diners Club
 CALL 0895 58111 Ext. 247 or 269 or Write to

tm1 WORD-STAR is a trademark of Micropro
 tm2 VISICALC is a trademark of Personal Software, Inc
 tm3 CP/M is a trademark of Digital Research

METROTECH MAIL ORDER
 WATERLOO ROAD
 UXBRIDGE
 MIDDLESEX UB8 2YW

enclosing cheque, PO's payable to METROTECH

• Circle No. 147

Is it time to buy a complete solution instead of just a computer?

A complete working system which fits your requirements. A system which is up and running your application the day it arrives. A system which gives you direct access to an automated filing cabinet.

A few years ago there was little option when acquiring a computer to adopting a Do-It-Yourself approach.

Now Digitus offers an alternative.

A computer, any suitable, robust computer, and a MFY solution.

A Made-For-You solution.

A solution instead of a vast array of machines, software packages and price-lists.

A solution which can fit comfortably into

an office environment, run by office staff, almost as simply as a TV-cum-photo-copier.

A solution which can contain some of your favourite boxes. Apple boxes, North Star boxes, Cromemco boxes, Data General boxes, ETC boxes.

A solution which performs in BASIC, COBOL, FORTRAN, PASCAL, or whatever best suits your environment.

A solution with printers and display screens and special terminals and systems software and programs all linked together, and working, and running your applications.

Choosing, designing, procuring, programming, installing and establishing systems are some of the elements which go into a Digitus solution.

We have already provided complete systems for number processing, word processing, information management, order processing, accounting, graphics, control processing, costing, linear programming, insurance, pricing, membership records, personnel, matching, broking, etc.

Working in partnership with you we can provide a complete system to fit your needs. Document it clearly. Train your people. Make it perform for you.

A computer is only part of the answer. Ask Digitus to provide you with a complete solution. Call us for an appointment, or complete the coupon and we'll call you.

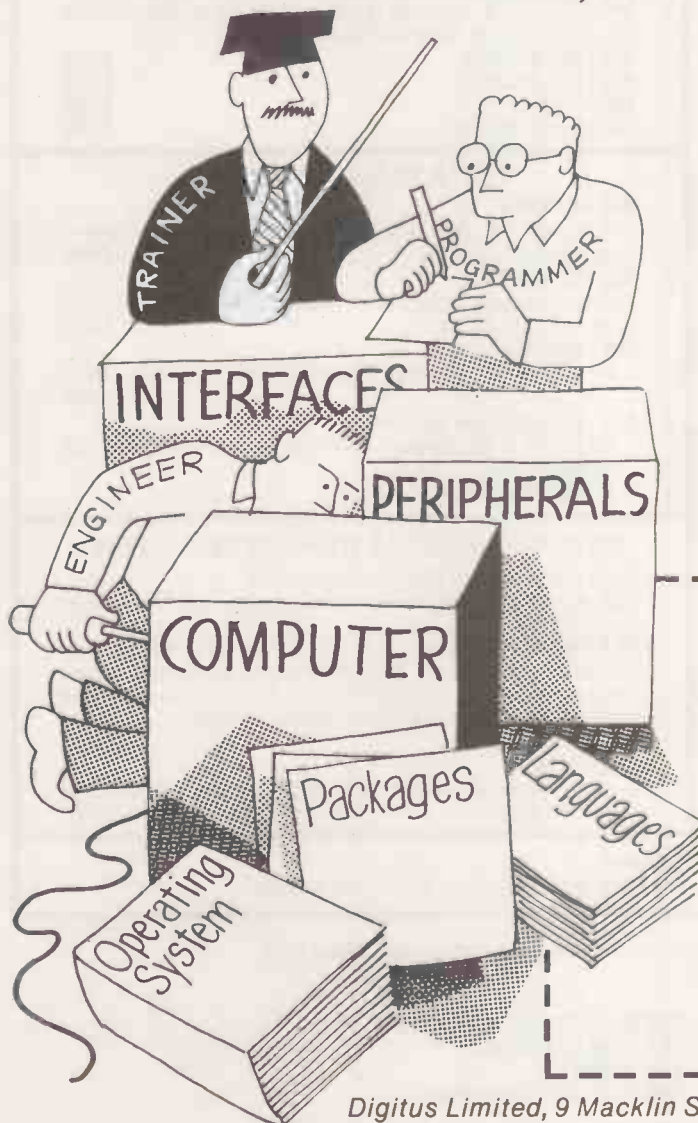

Digitus

Name _____

Position _____

Company _____

Address _____

Tel _____

Application _____

PC1/81

Digitus Limited, 9 Macklin Street, Covent Garden, London WC2. Tel: 01-405 6761

• Circle No. 148

The advancing frontier

IT IS NO secret that a major factor in the advance of micro-electronics — or its destructive progress, depending on your point of view — is the education of the citizenry to cope with computers. At the moment, that is happening in a spasmodic fashion in all kinds of places.

There are people who go or are sent on courses of all kinds and many, no doubt, return the wiser for them. There are those who find that computers have been wished on them and are obliged to learn. Often, their stories are worth hearing. There is a raggedly generation of schoolchildren — some from schools which have heard there is such a thing as a micro, but have never seen one; and others where daily life is deluged in silicon.

There are still children learning computing by punching cards and sending the packs to the local university computer centre and trying to decode the error messages for the next two weeks. As Kutuzov, the man who, in partnership with Generals Janvier and Février, saved Russia from Napoleon said: "Train hard, fight easy". They will be the children to watch in the eighties.

BBC and ITV are each working on their own computer literacy projects and so two generations of TV computer buffs will arise. Already, there are squabbles about the design of machines to be offered with these projects — at laughably low prices — and over the standard languages they are to employ. As ever, attempts to produce unity will probably result in even worse confusion. It is part of the rich warp and woof of life.

Slowly, unevenly, like the tide rolling-in over a great expanse of sand that looked flat when dry, but now admits little rivers of sea and divides into bays and headlands; so familiarity with computing spreads slowly and unevenly through the people.

It is not a subject which can be learned like many others. When engineering became a force in the world in the early 1800s, it was finitely learnable. Even today's engineering products cannot contort themselves into that many different states. After all, a washing machine has a limited number of legal conditions — it is in the middle of a hot wash and now doing the third rinse, or it is warming the water for delicates and blankets. There are also only a few ways it can go wrong.

A computer is quite different. It is physically impossible to test even the hardware thoroughly, and to test the simplest in all its possibilities out of the question. That has all kinds of interesting consequences. The first is that there is no hard-and-fast boundary between hardware and software constructors and their customers.

The makers cannot do more than sketch roughly how they think their wares should work; their customers must test them and extend them because there are not enough hours in the day for anyone else to do it. The second is that the experts disappears. He can no longer rely on an accepted, total, complete body of knowledge. He, like everyone else, is swimming in a sea of opportunities — but also of ignorance — that computing has brought.

A favourite example is the linguist. If you had asked any competent linguist 10 years ago whether he understood the structure of the English sentence, he would reply that, thanks to Noam Chomsky, the subject was an open book.

Ask any competent and honest linguist now and he will tell you that many sentences are understood, but that the whole of English is an enormous mystery. It is the computer that has killed his certainty. Programs have been written to parse sentences according to the infallible recipes of the experts — and they do not work.

All kinds of things which experts said they knew, now appear, thanks to the spread of computing, not to be known after all. One can expect that trend to intensify as more subjects become computerised, as more people grow used to them, as more skills of human existence are sacrificed to the mindless test of program execution. If you understood, the program will run; if you did not, it will not.

The microcomputer is intensely anarchic. It is not surprising that in some schools the people hindering computer education are the computer teachers. Their role has been diluted from: "Face the front, pay attention to me", to: "Is there anything I can do to help? Thank you for asking".

The impact of computing, or rather the straightforward, commonsense approach to solving problems which computing imposes, gradually teaches us that many revered intellectual skills were empty shams — shams which survived because only the experts had ever been able to devote the time to processing the data or knew how it had been processed.

As another example, consider the *Limits to Growth* program in November *Practical Computing*. Like many, I had been worried by the original Club of Rome forecasts of 1972. Now that I see the crudeness of the assumptions which underlie the work, I wonder that anyone was taken in. The world is clearly a great deal more complicated and although it may be going to hell in a handcart, it is by no means such a simple handcart as the pessimistic millionaires may have thought.

As a corollary to this, consider just the U.K. economy. Economists will no doubt confide that they understand how the economy works. Whether that assertion is so or not can be tested easily by letting them write computer programs to predict how the economy is about to perform. They do, avidly, and one has to report one uniform fact about the resulting programs: they do not work.

It seems that the usefulness of computers at the highest levels of government and industry is extremely limited. Yet, it is not the computers which are no good, but our understanding of how government works which is deficient. How is Mrs Thatcher to reduce inflation? No computer can tell her because a computer would know only if someone understood how the economy works — and they do not.

The availability of these intellectual drudges has shown us that we understand, in the sense that we can write a computer program to do it, precious little. Furthermore, since those things we do understand can be written in some language, and since any moderately intelligent person can understand anything anyone else understands. Understands in the sense that he can write an accurate, necessary and sufficient account of how to do it — whatever it is.

So the advent of computing divides human knowledge into two clearly-defined areas: the known and trivial and the unknown and baffling. The frontier is always advancing, like a torch shone in a dark attic. The exciting and mysterious objects guessed at by the dim light filtering under the eaves turn out to be boring old coal scuttles when you take them over by the trapdoor in the light. The lighting torch of computing turns the thrilling and unknown into the known and banal.

Widespread computer education may not progress as supposed and its results may be totally different from what many hope. It may produce a new generation of thrusting youth, ready to carry this tired old country into economic health and a respectable place in the family of nations. It may, in the process, dissolve all our intellectual ivory towers like so many sandcastles as the tide comes in. □

Our Feedback columns offer readers the opportunity of bringing their computing experience and problems to the attention of others, as well as to seek our advice or to make suggestions, which we are always happy to receive. Make sure you use Feedback—it is your chance to keep in touch.

Currency interest

THERE ARE certain important factors missing from Dr Taylor's strategy for buying foreign currency which appeared in the September issue.

Firstly, there is the matter of interest differentials. If, for example, one incurs overdraft interest now — or forfeits deposit interest receivable — on a pound sterling account to buy Swiss francs for a winter sports holiday early next year, there is the brunt of pound sterling interest rates to beat.

The interest receivable through placing the Swiss francs bought in a deposit account would be negligible. Were a forward contract for a small sum to be available through a foreign-exchange dealer, the interest factor would be reflected in his charges.

A probable area for economy would be a study of the buy/sell margin rates, which tend to widen during periods of crises or uncertainty. For example, a currency could be quoted during a period of stability at 8.80/9.20 to the pound sterling, giving a mid-point of nine.

During a spell of uncertainty the quote could become 8.50/9.50 still having the same mid-point. Thus anybody buying 20,000 units of this currency would pay an additional £80 through buying in this period. It pays to monitor the margin, expressing the buy rate as a percentage of the sell rate and to buy when the percentage is reasonable.

**Roger Standing,
Geneva,
Switzerland.**

Commodore stars

I READ WITH great interest your September editorial on British failings. While I followed most of the sentiment and reasoning you put forward, I believe there may be some bright stars on the horizon.

Indeed, some exciting British software is being produced at Commodore for the Pet and we have just started to export a major amount from the U.K. to Commodore companies overseas. It might interest you to know that the following packages are now to be marketed on a worldwide basis by Commodore:

- Pascal Compiler
- Wordcraft
- Anagram Stock Control
- Communicator — Pet-to-deck intelligent terminal package
- Ozz — a user-definable database product

It pleases me that these packages form a very important part of our range of software for the Pet — British software talent is expanding and the U.K. is becoming a

centre for development in the Pet micro field. So perhaps: "We British, in our sturdy pragmatic way, are doing better".

**Kit Spencer,
Commodore Business Machines,
Slough,
Berkshire.**

Sorcerer storage

IN HIS article on the Presidential Election program, October 1980, Alan Bayliss suggested that by loading the Basic as single-key instructions, less store space would be occupied. In case that misleads anyone, it should be said that the Sorcerer stores the instructions as the codes for the single-key form, however the lines are entered.

Perhaps what Bayliss had in mind was that the shorter form occupies less screen space and that could be relevant to a program so densely packed as his.

We have been too busy converting Supertank, July and August 1980 issues, for the Sorcerer to make a start on the election program, but it looks interesting. Now our monitor-listing task is complete, we will probably defer digging into the Basic ROMPAC until we have tried the Presidential battle.

**Don Thomasson,
Harrow,
Middlesex.**

Basic burial

I WRITE to bury Basic, not to praise it. I cannot see how any computer user — whether on a mainframe, a mini, or a micro — can think that Basic is superior to the other high-level languages available today. Although I do not know Pascal, the main rival of Basic in the micromarket, I have programmed with Basic, Fortran, and assembly language, and I find Basic to be the most unsatisfactory of the three.

Assembly language aside, Fortran and other similar languages are far better programming aids than Basic. Fortran boasts alpha-numeric variables up to six characters, line labels only where needed, maths capabilities far beyond those of Basic, more powerful if statements, more varied data types, better control over I/O and I/O format, and more direct control over variables, therefore eliminating all string variables and the STR\$, CHR\$, etc., functions.

Moreover, the Fortran subroutine and function handling simplifies program development considerably, for, unlike Basic, parameters are passed easily between the sections of the program, and as subroutines have names, there is no need for the totally meaningless and confusing "GOSUB 10560."

Not to be overlooked in languages such as Fortran, Pascal, Cobol, and APL is the fact that they all use a compiler. While it may be more complicated for the beginner to use, an hour of practice with the compiler will have even the inexperienced user working smoothly.

The most obvious advantage of a compiler is that the compiler code executes much faster than interpreted Basic, and good compilers will produce code which is almost as fast as if the program were written in assembly language, therefore eliminating the need to jump to a machine-code routine when speed is necessary. The compiled code also occupies less core/disc/tape space than ASCII Basic, so larger programs can be run on small machines.

I feel that anyone who has used both Basic and another high-level language extensively will find that while Basic is a satisfactory language with which to learn programming, and that is what it was designed for, it simply cannot compete with the more advanced languages. I hope *Practical Computing* and its readers will help to make the change to these languages, and so advance microcomputer programming.

**John TeSelle,
Oxford.**

TRS-80 true colours

IN YOUR article on page 46 in the October 1980 issue, you refer to the Model III as a colour computer; it is not. There will be a new computer added to our range which is colour and will be called, TRS-80 Colour Computer.

**E A Russel,
Tandy Corporation,
Wednesbury,
West Midlands.**

Landscape architecture

I AM a fifth-year student of landscape architecture studying at Leeds Polytechnic. As a part of my studies, I am preparing a dissertation which will fall within the broad title area of the application of microcomputers to landscape architecture, although the finished work will probably have a more specific title.

I am writing a program to aid landscape architects in the selection of plant materials and although my programming experience is very limited — I have used an Apple II and Research Machines 380Z — I am encouraged to see the potential use of a micro even to a novice such as myself.

As a part of my research, I hope to

(continued on page 44)

BUTEL-ATHENA

The Ideal Small Business System

The ATHENA is just what your growing business needs. The high performance ATHENA can deal with all your accounting, stock control, word processing and other requirements. It is simple to use, has only a single power lead and can be expanded with multiple terminals and more storage.

Prices start at £5694. Write or call for details.



ATHENA Dealerships Available.

BUTEL
Technology for business

Butel-Comco Limited
50 Oxiord Street,
Southampton,
England SO1 1DL
Telephone 0703 39890
Telex 47523

(continued from page 42)

identify other users in similar fields to investigate their successes and failures in putting their programs into operation.

I have listed some of the potential operations which I may investigate with respect to computers:

- A selection system for plant material — trees, shrubs, etc. — storage of large quantities of complex data which is easily and quickly accessible.
- Contouring exercises; calculation of cut and fill — use of graphics tablet to measure irregular areas and volumes; conversion from plan to section or elevation.
- Planting design; planting plans drawn to scale on a graphics tablet; Calculation of areas, densities and plant quantities; production of planting schedule.
- Suppliers' index; relatively simple file of suppliers; lists of available species, sizes and prices; regular editing and additions essential.
- Word processing; production of large documents, specification and contracts requiring constant amendments.
- Production of sections, elevations and perspectives; advanced graphics programs, perhaps unfeasible at present on micros, but of relevance in terms of future development.
- I would be grateful for any information from any users or user groups who could share useful experiences, or of any publications which are of a more specific relevance to people within my field or similar professions.
- I was, of course, interested to read the applications story by Martin Hayman in the October issue concerning the Syon Park Garden Centre and hope to contact the centre in the future.

Chris Sterry,
Leeds,
West Yorkshire.

Job safeguard

WITH reference to the interview of Neil Macfarlane, Under-Secretary at the Department of Education and Science in the October edition, I would like to say that during the past year, I estimate that the school of which I am a pupil has spent more than £4,500 on micros and peripherals — all U.S. or Japanese.

I would like to suggest that schools, colleges and other educational establishments should buy those items only if manufactured in the U.K. That would help safeguard British jobs.

D Maltby,
Sheffield,
South Yorkshire.

Challenge of ZX-80

FIRST I MUST congratulate you on your unbiased articles and the excellent review, July issue, of the ZX-80. It is also good to see that you now have a regular club page for this popular little computer.

However, I feel that I must take issue with those who would wish to over-complicate the programming of the ZX-80. I believe that its main asset is its uncluttered simplicity which make the pro-

grams a joy to write and a challenge to conceive without resorting to complicated methods.

I have written and taped a modest library of 11 programs, seven are dedicated to basic education and are used by my 9½-year-old son, who finds them much more fun than school homework.

Of the remaining programs, one is an enhancement of the ZX-80 manual's die throwing which enables double dice — U.S. crapps — to be played.

To fit the program into the on-board 4K RAM, no REM statements have been used and, where applicable, the left-hand die is always assumed to carry the higher number. With extra RAM, either of the dice could assume the higher value simply by reversing the sequences contained in line groups 300 to 2130 and changing the value of X to RND(37). That would give the game 15 more random chances. Obviously, lines in the 400; 800; 1400; and 1900 groups cannot be altered as both dice are displaying the same number.

Finally, another contribution to the already much-written-about topic of LOADING and SAVEing programs on cassette tapes. Having suffered the same disappointments as many others when trying to LOAD from tape, I contacted Science of Cambridge which sent me a copy of its leaflet which states, among other things, that an AC output peak-to-peak voltage of at least six volts is required at the EAR socket before LOADING can be successful.

Consequently, I took my machine to be tested only to find that it had a DC bias which was effectively cancelling the required AC.

Along with the cassette recorder, I received a good tip and some valuable advice. The tip concerns the remote socket to be found near the MIC socket in most recorders. If a locking push-to-make, push-to-break switch is wired to a 2.5mm. jack plug, the plug, when inserted in the remote socket enables the record and play operations to be controlled by the switch. It is not recommended for re-wind or fast forward. Obviously, the required keys must first be depressed but, if that is done with the switch in the off position, they do not work until the switch is pushed to on.

There are two advantages; first, with the button mounted near the keyboard, control is easier and second, the use of the method disconnects the internal microphone so that no motor hum or stray noise is picked up during the silent pause before the program starts.

The last piece of advice I was given was that many recordings and play-backs, including those of programs, can be spoiled by the fact that the tape is not allowed the second or two it needs to reach the correct speed before either recording or playing back. A good idea is to count a slow one before hitting the new-line key in both cases.

The ampersand signifies a space which must be keyed. The graphic character used throughout is SHIFT 'F'

```

10 LET A$ = "&□&" 1130 GO TO 2250
20 LET B$ = "□" 1200 PRINT D$, B$
30 LET C$ = "&&□" 1210 PRINT A$
40 LET D$ = "□&□" 1220 PRINT D$, C$
50 LET X = RND(22) 1230 GO TO 2250
60 CLS 1300 PRINT D$
70 GO TO X* 100 1310 PRINT D$, A$
100 GO TO 50 1320 PRINT D$
200 PRINT 1330 GO TO 2250
210 PRINT A$, A$ 1400 PRINT D$, D$
220 GO TO 2250 1410 PRINT
300 PRINT B$ 1420 PRINT D$, D$
310 "&", A$ 1430 GO TO 2250
320 PRINT C$ 1500 PRINT D$, B$
330 GO TO 2250 1510 PRINT A$, A$
400 PRINT B$, B$ 1520 PRINT D$, C$
410 PRINT 1530 GO TO 2250
420 PRINT C$, C$ 1600 PRINT D$, B$
430 GO TO 2250 1610 PRINT D$
500 PRINT B$ 1620 PRINT D$, C$
510 PRINT A$, A$ 1630 GO TO 2250
520 PRINT C$ 1700 PRINT D$, D$
530 GO TO 2250 1710 PRINT A$
600 PRINT B$, B$ 1720 PRINT D$, D$
610 PRINT A$ 1730 GO TO 2250
620 PRINT C$, C$ 1800 PRINT D$, B$
630 GO TO 2250 1810 PRINT D$, A$
700 PRINT D$ 1820 PRINT D$, C$
710 PRINT "&", A$ 1830 GO TO 2250
720 PRINT D$ 1900 PRINT D$, D$
730 GO TO 2250 1910 PRINT A$, A$
800 PRINT B$, B$ 1920 PRINT D$, D$
810 PRINT A$, A$ 1930 GOTO 2250
820 PRINT C$, C$ 2000 PRINT D$, D$
830 GO TO 2250 2010 PRINT D$
900 PRINT D$, B$ 2020 PRINT D$, D$
910 PRINT 2030 GO TO 2250
920 PRINT D$, C$ 2100 PRINT D$, D$
930 GO TO 2250 2110 PRINT D$, A$
1000 PRINT D$ 2120 GO TO 2250
1010 PRINT A$, A$ 2200 PRINT D$, D$
1020 PRINT D$ 2210 PRINT D$, D$
1030 GO TO 2250 2220 PRINT D$, D$
1100 PRINT D$, B$ 2250 INPUT X$
1110 PRINT "&", A$ 2260 IF X$ = ""
1120 PRINT D$, C$ THEN GO TO 50
    
```

The game can be played by two or more players, there is no upper limit. The combination shown when 'RUN' is pressed is discounted. To throw, press NEWLINE. At the beginning, each player has one throw, the one with the highest combination starts.

The player who has the dice keeps them until he or she throws a losing combination. Each turn may consist of one or more throws as defined. The following, if thrown on the first 'throw' of a 'turn', are losing combinations:

Double one
Double six

The following, if thrown on the first throw of a turn, are winning combinations:

Any combination to make seven
A six and a five — 11

If any other combination is thrown on the first throw of a turn, the player throwing continues the turn until one of the following occurs:

- The same number, in any combination, is thrown, in which case this is considered to be a win and the same player starts a new turn.

- Any combination to make a seven or an eleven is thrown, in which case this is considered to be a lose and the player hands over the dice to the next player in rotation.

Neville Falkiner,
Leeds,
West Yorkshire. □

GAMBIET '80

The World's No.1 Microcomputer Chess Program by Wim Rens

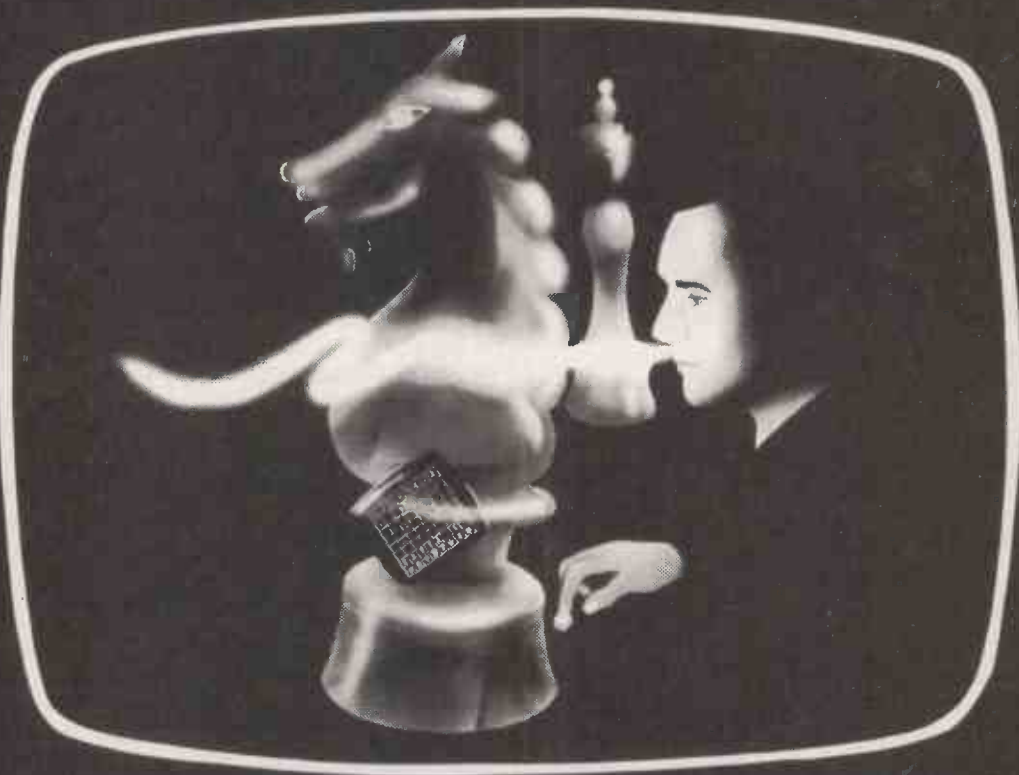

Gambiet 80 was the most successful commercially available Chess Program at the official World Microcomputer Chess Championship in London, September 1980.

FACILITIES INCLUDE:



- * 6 levels of play from speed chess to tournament level
- * Graphic board display
- * Chess Clock
- * Game record in standard notation on the screen and optionally on a printer
- * Board set up for solution of chess problems
- * 'Take-back' facility
- * Continual display of moves being evaluated by the program
- * Mate anticipation

The fastest serious program for the TRS-80 or Video Genie

Name _____
Address _____

Please send me:
Gambiet/80 on tape for the TRS-80. £19.95

Total £ _____ Signature _____

  CHEQUE (tick)

Credit Card No.

Send to: Microtrend Ltd.,
P.O.Box 51, Poteley Bridge,
Harrogate, North Yorkshire HG3 5DP

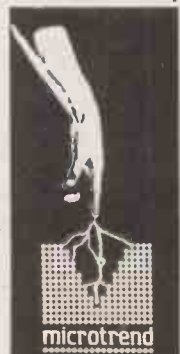

PC

• Circle No. 150

Four models in Rair Black Box III range

A NEW range of British-built microcomputers has been launched including one with an integral 5¼in. Winchester disc system. The Black Box III range is the latest in the line of microcomputers to emerge from the London-based manufacturer Rair Ltd since it introduced its first microcomputer in 1978. The 5¼in. discs have an unformatted capacity of 3.5 or 6.9MB and the system will sell from £3,500.

There are four models in the

new range, all of which based on the 8085 chip from Intel. The Model 3/10 starts with 32Kbytes of RAM expandable to 512KB with single mini-discs drive support and dual serial I/O ports. Mid-range systems, the 3/20 and 3/30 add dual mini discs and built-in 5¼in. Winchester discs, while the top of the range, the Model 3/40, incorporates an 8in. Winchester disc.

The basic RAM of each model can be expanded in 16 or

64KB increments to a maximum of 512KB. Up to eight Winchester discs can be connected to a single computer, giving a total on-line storage capacity of up to 200MB on one system.

According to Rair managing director, Mark Potts, the Black Box III range offers almost as much power as some minicomputers but at five to 10 times less cost. He believes that one of the key features of the new range is its multi-user, multi-terminal networking capability. Up to 16 serial I/O ports can be added to each model in the range. From basic single-user support, each model can be expanded to provide multi-user, multi-terminal support on a single system or in a network, using shared processor and file resources in a multi-computer distributed processing system on any size. More details from Rair on 01-836 4663. □



PC-3200 leads the Sharp attack on business computer market

THE JAPANESE are beginning to show that they really mean business where the task of developing new microcomputers is concerned. In the last 18 months, Sharp has introduced the hardy MZ-80K, sound and solid if not exactly innovatory, the novel PC-1211 hand-held computer, or calculator programmable in Basic, and now has produced a new computer, the PC-3200, designed, and aimed at the business market, which seems to show how far and fast the company ideas about computers have developed.

The PC-3200, like the MZ-80K, is based on the Z-80A chip but it has a separate alphanumeric keyboard and 80-column screen, with selectable 40 or 80 characters per screen, two discs and a printer. There is 64K of RAM and 32K of ROM which can be expanded

up to 72K. The Basic is held in the ROM.

The double-sided, double-density mini-floppies and the 80- or 132-column printer is supplied with the complete system which will be sold for less than £3,000.

Developments to the PC-

3200 are already being discussed and some of future Sharp plans have been announced. They include 8in. floppy disc with 1MB, an RS232 port, a general-purpose I/O card and a RAM upgrade to 96K, all of which should be ready by the summer. □



News of Cobol and Coral 66

COBOL and Coral 66 are now available for the Apple for the first time. MicroFocus is offering both CIS Cobol and its Coral 66 compiler on the Apple under Digital Research CP/M operating system. Both the products run in conjunction with the Z-80 Softcard, developed by Microsoft, which makes the Z-80 instruction set available in addition to the native Apple 6502 processor.

CIS Cobol is an ANSI 1974 Cobol compiler designed for interactive use on small computer systems; it supports an optional screen formatter/program generator. Coral 66 is a real-time programming language and is the British standard for defence computing.

Brian Reynolds, chairman of MicroFocus is clearly aiming the products at the world market for Apples: "With more than 150,000 Apples installed, we see a tremendous market opportunity", he says. MicroFocus is based in London and further information from 01-722 8843. □

Megastore 8in. drive

IT HAS, of course, been possible to link 8in. discs to the Apple by a variety of means, but now Vlasak Electronics has produced some 8in. drives specifically designed for the Apple.

The Megastore is supplied for plug-in-and-go use with Apple increasing its on-line storage capacity to 1MB. The case is styled to match the Apple and costs £1,970. □

MUSE opens advice centre for teachers

MUSE, Microcomputer Users in Secondary Education, has started a national information and advice centre for teachers using small computers in schools. The Centre will be located in Birmingham and will be manned full-time by a teacher and supporting research and secretarial staff.

Bob Trigger has been seconded from Marsh Hill Comprehensive School, Birmingham, and will take up the

post of Information Officer from January 1, 1981. Bob Trigger teaches computer Studies and has recently been involved in a software development project for computer-assisted learning.

The funding for the centre has been provided as part of the Government £9million Microelectronics Development Programme for schools and colleges. The address of the new centre is MUSE, Freepost, Bromsgrove, Worcestershire, B61 7BR.

4K RAM for Aim 65

AIM 65 users can obtain a 4K RAM extension in addition to the 4K already available, a 4K EPROM socket with switchable address, an additional VIA giving 16 I/O lines in addition to the 16 already available and a Euro-card connector all by removing the 6502 chip from its socket on the Aim and plugging in the Eurocard-sized CUBIT card into the exposed socket and then replacing the 6502 chip on the CUBIT.

CUBIT has been developed by Control Universal Ltd, costs £75 and is available on Harlow (0279) 31604. For an extra £15 one can add a crystal and a 6502 chip and one has a very effective, small single-board computer.

Versawriter makes full use of Apple graphics facility

ONE OF the most popular features of the Apple has been its graphics facilities but it has often proved expensive and cumbersome to make full use of them. A new product from the States and now available from Apple dealers should help solve the problem.

The Versawriter is a simple version of the Apple graphics tablet, and resembles a draftsman's pantograph, with a levered bar which can be moved to any point on the tablet. The software supplied with it gives the user a range of commands and special shapes

for use in drawings. They include electronic, electrical, circuit lay-out, architecture, landscape, chemical apparatus, chemical symbols, plumbing and others.

Drawings can be scaled-up and down and rotated; there is a choice of 123 colours and text can be added in five sizes and four colours. The whole unit with the software is available at a one-off retail price of £149 from Micro Management on (0473) 57871 and substantial discounts are available for dealers and others who intend to buy in quantity.

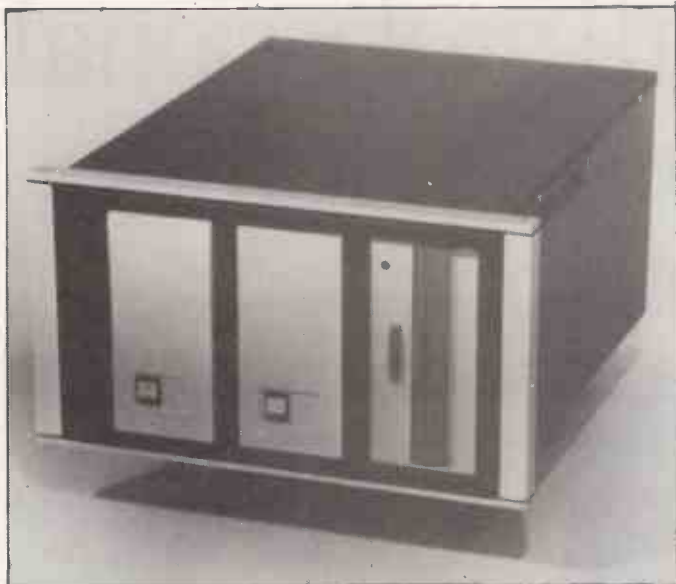

The Super Gemini from the General Robotics Corporation of Wisconsin in the States, includes an 8in. 8MB Winchester drive and a single 1.25MB floppy drive and will be sold in the U.K. for slightly more than £8,000. The system is based on the LSI-11/2 chip and includes 64K of RAM. As an option, one can buy the Super Gemini based on the LSI-11/23 chip and with 256K RAM for £11,460. Wilkes Computing Ltd in Bristol has been appointed the U.K. distributor for all the General Robotics computers. Telephone: (0272) 25921.



The latest addition to the growing range of intelligent peripherals is a new 20MB version of the Corvus Winchester disc system. While providing twice the capacity of the 10MB discs, the new system will cost only 20 percent more.

New Gemini 801s have RAM-held programmable character sets

A NEW U.K. microcomputer company, Gemini Microcomputers, has been founded by John Marshall, ex-managing director of Nascom which went into receivership earlier this year and is now under a new owner.

The Gemini range of microcomputers includes three models, the basic 801 and two versions of this, the 801A and 801B, all of which have been designed on a consultancy basis by Specialist Micro Design, a company formed by ex-Nascom engineers after it went into receivership.

The 801 is a Z-80-based desk-top system which can run the Digital Research operating system CP/M. For £1,075 plus VAT, it is supplied with 64K of RAM and twin 5in. double-

sided double-density floppy discs offering 630Kbytes of on-line storage. It can run an 80- or 40-column screen and has an ASCII keyboard, an RS232 interface and an optional parallel interface.

One interesting feature is that the character set is held in RAM and can, therefore, be programmed to suit the user. For example, the 801 could act as a low-cost terminal for an APL system. A CRTC chip gives a good graphics capability.

Systems 801A and 801B use cassette rather than floppy disc storage and have 8K Basic rather than CP/M. The 801A costs £695 plus VAT and the 801B £575 without an enclosure. According to Marshall, the systems are available in

January. An S-100 bus interface is planned for next year.

Discover the full professional power of Hewlett-Packard's personal computer.

Now you can extend the HP-85's power simply by plugging in high-performance printers, plotters and flexible disc systems.

Professional power where you need it.

The HP-85 puts professional problem-solving power wherever you need it. There's a video display with high resolution and editing capability. A whisper-quiet thermal printer for hard copies of display graphics and alphanumerics. A magnetic tape unit with up to 217 K of storage per cartridge. And a complete keyboard, including eight keys you can define yourself. Powerful, easy-to-use features, thanks to HP's extended BASIC programming language.

Decide the peripherals you need.

HP's Interface Bus (HP-IB/IEEE-488) lets you add up to 14 peripherals or instruments. No need to write special operating programs - HP's peripheral ROMs do it for you.

New HP enhancement ROMs and modules let you expand to 80 K bytes of operating system, without reducing user memory. The HP 2631B printer means high-speed, high-quality printing. And the HP 7225 Graphics Plotter gives you high-resolution, publication-quality graphics on paper or film.

For extra memory storage, use the HP 82900 series of 5¼" flexible disc drives. Each drive gives you about 270 K bytes of formatted storage on double-sided, double-density discs. The operating system is in the Mass Storage ROM, leaving the HP-85 main memory free.

Behind the HP-85 computing system is the strength of Hewlett-Packard. Continuous commitment to quality. One-source service and support. Even on-site service within 24 hours.



For more details or a demonstration, contact your nearest HP Dealer shown below.



**HEWLETT
PACKARD**

Contact your nearest dealer for a demonstration. Aberdeen Tyscal Typewriter Services, Tel: 29019; Belfast Cardiac Services, Tel: 625566; Birmingham Anglo American Computing, Tel: Colshill 65396; Taylor Wilson Systems, Tel: Knowle 6192; Bournemouth South Coast Business Machines, Tel: Wimborne 893040; Brighton Office Machinery Engineering, Tel: 689682; Bristol Decimal Business Machines, Tel: 294591; Cambridge Cambridge Computer Store, Tel: 65334; Chelmsford Automatic & Electronic Calculators, Tel: 69529; Dublin Abacus Systems, Tel: 711966; Edinburgh Business & Electronic Machines, Tel: 226 4294; Holdene, Tel: 668 2727; Glasgow Robox, Tel: 221 5401; Leeds Holdene, Tel: 459459; Leicester Sumlock Services, Tel: 29673; Liverpool Rockliff Brothers, Tel: 521 5830; London Automatic & Electronic Calculators, Tel: 247 1886; Euro Calc, Tels: 739 6484, 636 8161, 405 3113; Sumlock-Bondain, Tels: 250 0505, 626 0487; Manchester Automated Business Equipment, Tel: 432 0708; Holdene, Tel: Wilmslow 529486; Newcastle Thos Hill Group, Tel: 739261; Newport Micromedia Systems Ltd, Tel: 59276; Reading CSE Computers, Tel: 61492; Sintrom Electronics, Tel: 85464; Royston (Herts) Electroplan, Tel: 41171; Southampton South Coast Business Machines, Tel: 22958; Sunderland Thos Hill Group, Tel: 42447; Tunbridge Wells D J Herriott, Tel: 22443/4; Wallingford Midas Advisory Services, Tel: 36773; Watford Automatic & Electronic Calculators, Tel: 31571; Woking Petalect Electronics Services Ltd, Tel: 69032; Worthing Office Machinery Engineering, Tel: 207292.

• Circle No. 151

Comart Communicator may help stem tide of foreign imports

U.K. manufacturers of microcomputers seem to be gearing themselves for a stronger attack on the market at a time when the share of the market taken by Japanese and U.S. computers is still rising. The latest microcomputer to be announced is from one of the strongest microcomputing groups in Britain — Comart. Its new Communicator CP-100 has been built round many of the standards which have emerged in the microcomputing industry; a Z-80A chip, S-100 bus and CP/M. There is space for an additional seven S-100 cards and its disc controller is prepared for up to four disc drives.

The design of the Communicator indicates that one it is intended is with Prestel, Datel and viewdata telecommunications systems. David Broad, managing director of Comart claims that components have been selected which will be compatible with disc storage requirements in future 8in. and hard-disc models. The basic model will be sold for £2,295.

Comart is still a privately-owned company and has a turnover of over £4million pa. It has the distributorships for a

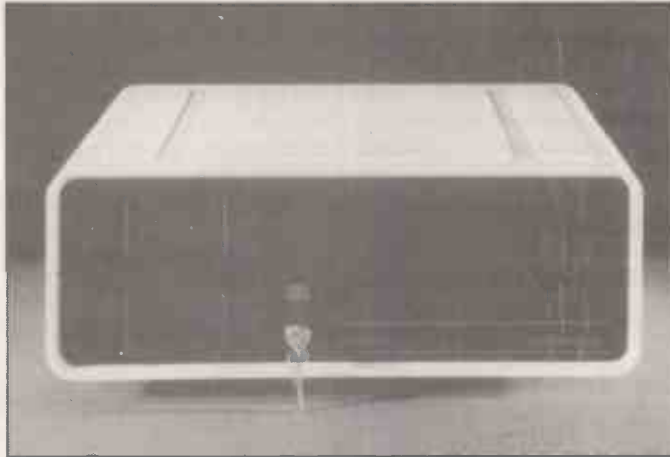

number of well-known microcomputers and, early in 1980, bought the Byte Shop Computerland chain of stores. The company also owns Xitan

Systems, a specialist south-coast computer company and Bytesoft, a software house based in Leicester. Details from Comart (0480) 215005. □

Most micros bought for business in U.K., Europe's top market

DESK-TOP and personal computers are finding their way into the business and professional community, with their original markets in science education and the home sliding into second place according to a study of the European market by the International

Data Corporation of London.

Last year 78,000 desk-top computers were shipped in Western Europe, with 52 per cent going into the business sector. By 1983, total shipments are expected to reach 425,000 with 64 per cent going to the business community.

IDC claims that Britain has the most developed market in Western Europe due largely to the concentration of efforts by the major U.S. vendors. At least 60 per cent of the small computers are already being sold into the business market, 24 per cent to the scientific market and only nine per cent to the home market. The market is forecast to grow at an annual average rate of 43 per cent until 1983 when the business sector will take 74 per cent of all the units shipped.

In the rest of Europe, West Germany is the most advanced with nearly 35,000 systems installed while fewer than 15,000 systems have been installed in France, primarily because of resistance to foreign products.

The main advantage that Britain has is the availability of software packages and the dealer/distributor network,

New Pasca 640 system

ANOTHER Japanese computer is to be launched on to the U.K. market. The Pasca 640 is a Z-80A-based system with 64K of RAM, twin 8in. floppies and a screen built into an integral unit and is sold for the competitive price of £3,300.

The computer will run CP/M version 2.2 and will include a number of special keys which could be used as dedicated keys by users running the Wordstar word-processing package.

According to Barry Motton, of Westrex, about 50 of the new units will be shipped into the U.K. each month from the beginning of 1981. When asked about the competition for the system, he claims: "It is not dissimilar to the Panasonic". Westrex can be contacted on 01-578 0950. □

although business users still complain of having to re-write substantial sections of programs to run them properly. Copies of the IDC report are available for £995 from IDC on 01-995 9222. □

CP/M-86 for Intel micros

DIGITAL Research, which developed the widely-used CP/M operating system for 8080- and Z80-based microcomputers, and the MP/M multi-user operating system, has announced CP/M-86, and operating system for Intel 8086/8088-based microcomputers.

CP/M-86 is the first of the Digital Research 16-bit products and has been designed to take advantages of the 8086 address space and speed, while expanding upon the facilities of standard CP/M.

The file format of CP/M, release 2, has been retained for compatibility. CP/M-86 can also function as a slave node in a CP/NET network. MP/M-86 and PL/I-86 will be announced shortly. □

If a pencil is not good enough, try **FIXOTAPE** as an answer to the perennial problem of tangled cassette tapes. Available for £1.99 from Jorephani Exports, Park Lane, Corsham, Wiltshire (0249) 714855. □

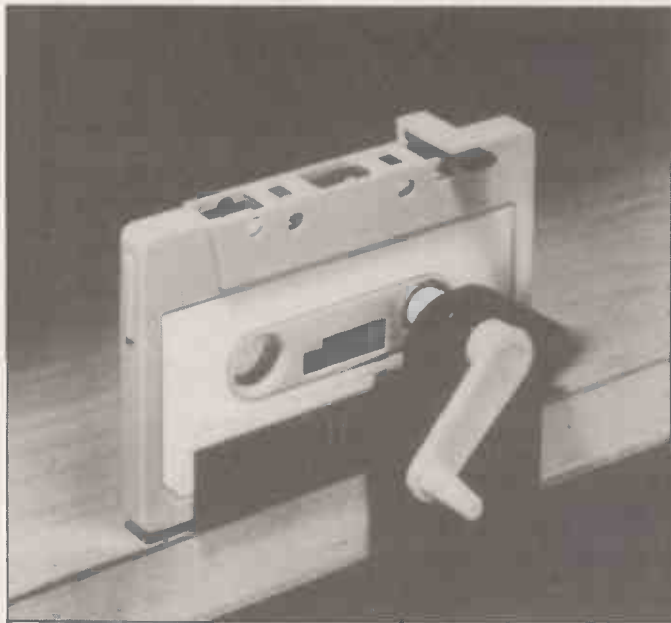

Vision-80 keeps electronic eye on your security operations

A SOFTWARE and hardware package called Vision-80 that, it is claimed, makes an ordinary TV camera into an almost universal input device for a micro has been announced by Southdata. The package consists of a digitising board which divides the TV picture up into pixels, a video-output board which displays the results on a monitor and a program written

in Z-80 machine code running under CP/M which scans the picture for moving objects.

The system can, it is claimed, detect objects moving in the picture and classify them according to size, speed and direction of movement. For example, a TV camera might be set to watch a lorry park at night; Vision-80 can be programmed to report the movement of lorries but to ignore

the movement of people, cars and animals which would otherwise cause false alarms.

The security industry is an obvious user for Vision-80, but it should have applications as well in production and the military. Southdata has a working prototype and are hoping to find licensees to put the system into production systems. Southdata Ltd, 221 Portobello Road, London. ☐

New scheme for shares

YOUNG HIGH-technology companies in search of venture capital and who are unwilling or unable to approach the Stock Exchange new Unlisted Securities' Market can now try turning to the over-the-counter market in shares, and in particular to a new scheme run by Harvard Securities Ltd which is aimed at young, high-technology companies seeking long-term risk capital to finance expansion and growth. Ring 01-928 8691. ☐

Inexpensive fibre optics

FOR A long time fibre optics have had the air of solutions no-one could afford to problems nobody could quite formulate. That was due largely to their high cost and reputation for trickiness. However, the Japanese have stepped in and removed the difficulties.

Their plastic fibres, are fine for short runs. For instance, 10 foot of fibre with diode receiver and transmitter at each end, costs about £6. Interfacing to digital equipment can be done with standard chips costing another £2 giving a noise-free communication link running at several 100 kHz for less than £10. Call Optronics on (0223) 64364. ☐

Apple II digital synthesiser can mimic musical instruments

A NEW digital music synthesiser has been introduced for the Apple II computer by a U.S. company and is now available in the U.K. from Microsense through its network of 250 Apple dealers. The Music System, it is claimed, can create the sounds of real musical instruments.

An editor program permits the graphical input of sheet music with standard musical notation. The polyphonic musical compositions can be played, in stereo, through the user's stereo amplifier and speakers or directly from card with stereo headphones. The card costs £294 from Microsense on (0442) 48151. ☐

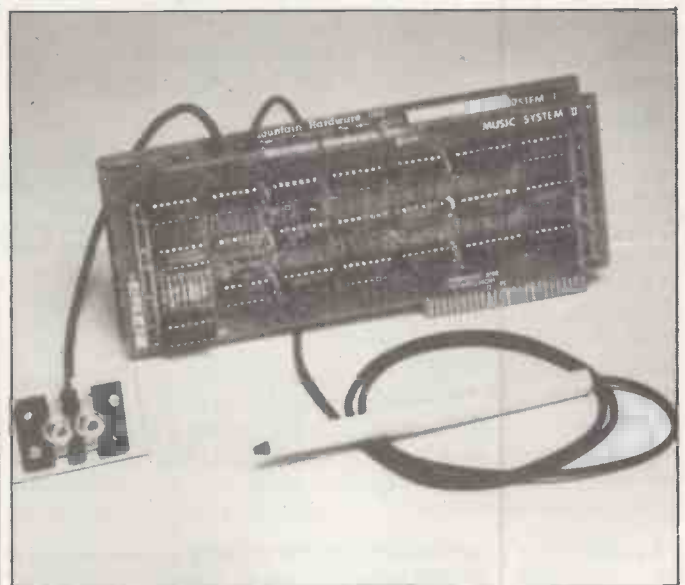

Model 100 graphics plotter has wide range of hardware interfaces and software drivers

A VERSATILE graphics plotter using A4 paper with an 0.004in. step has been introduced by Hal Computers and is available for £550. The Model 100 is manufactured by Strobe Inc and has hardware interfaces and software drivers for the Apple II, TRS-80, Pet and S-100 bus computers. An optional software package, providing vector generation and alphanumerics, which runs with most versions of Basic and Fortran, is also available.

The Model 100 plotter has an interactive digitising mode, allowing the user to enter directly into the host computer XY co-ordinates correspond-

ing to the pen location. It is controlled by the computer through two parallel output

ports and one parallel input. Hal Computers is based in Surrey, (97) 48346/7. ☐

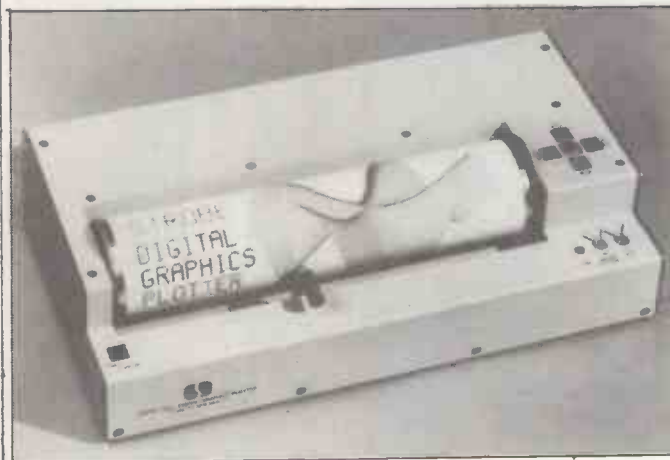

Aim, Sym video control

A VIDEO controller board for the Aim, Sym and Kim range of microcomputers has been released by Portable Microsystems of Brackley. The Video plug adjusts automatically to 40-by-20 or 80-by-20 screen widths and can be programmed for display formats up to 100-by-20 or 48-by-20.

The operating software is available on cassette, with the Aim and Kim tape formats supported, or in EPROM and has been designed to run with the Aim, Sym or Kim monitor programs without modifications to either the editor or the Basic. The card costs £196 from PMS on (0280) 702017. ☐

Accounting
Business Systems

TABS

The only fully integrated
 **apple**® accounting business
systems in front of you and
behind you.

TABS unique, low cost accounting systems* have been specially designed for small businesses that could profit from microcomputer assistance.

TABS not only provide the ideal accounting systems but also recognise that businessmen, although aware of microcomputer technology, may not be aware of just how simple it is to exploit.

Unlike other systems, TABS are fully modular which means that each module may be purchased separately and integrated to suit your own requirements. Just to make sure that we have left nothing to chance, TABS also offer a total service package that includes training courses, consultancy and free seminars through a rapidly expanding national dealer network.

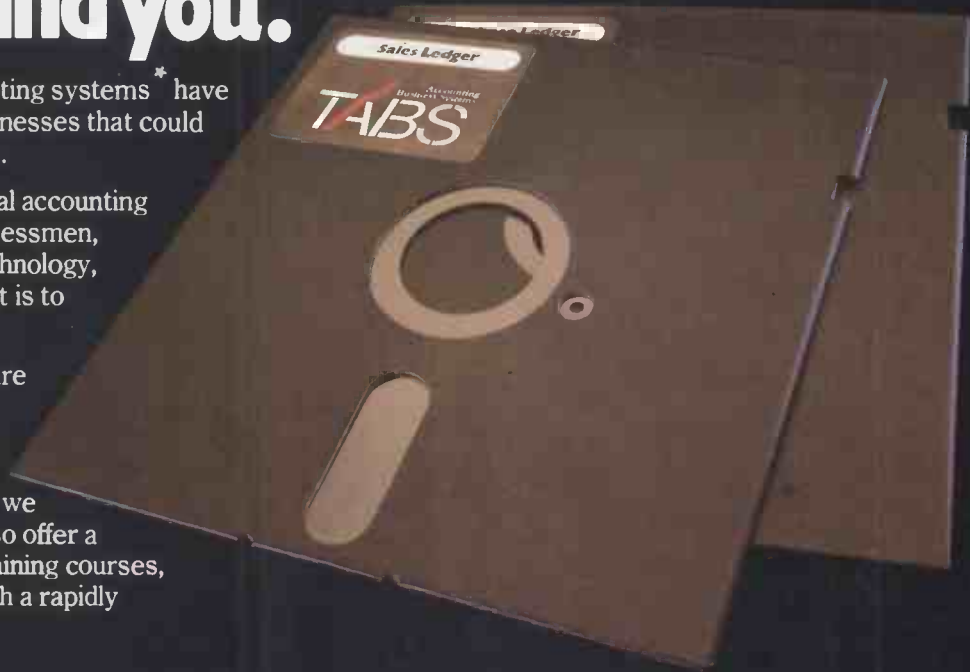

Expanding Dealer Network

Hexagon Services
Slough (0753) 21998
Micro Business Center
Wolverhampton (0902) 725687
Synapse
Chesham (02405) 72777
Aerco-Gemsoft
Woking (04862) 22881
Westwood Computers Ltd
Birmingham 021-632 5824
Capricorn
Worcester (0905) 21541
Shannons
Manchester 061-748 2339
Courtland Electrical
Oxford (0865) 779282
Microfen Computers Ltd
Sevenoaks (0732) 882759
Vega Computers Ltd
London 01-680 4484
Lux Computer Services Ltd
Watford (0923) 29513



*The Minimal System

The minimum system required to run the TABS modules is:-
Apple 48k
Disc with controller
Disc without controller
Silentype printer
TABS Firmware card
Total cost £2056

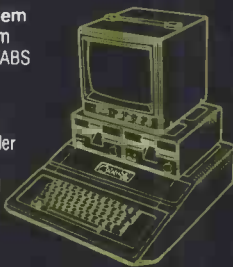

Topmark Computers
St. Neots (0480) 212563
Estate Computer Systems
Sleaford (Lincs) (0529) 305637
Blyth Computers Ltd
Wenhaston Suffolk (050 270) 371
Meclec
Shoeburyness Essex (03708) 5047
Microspol
Maidstone (0622) 858753

Each module costs an astonishingly low

£99

Modules include:

Purchase Ledger, Sales Ledger,
Nominal Ledger, Payroll, Stock Control, Job Costing,
Word Processing, Training, Support.

If you are interested in TABS low cost Accounting Business Systems, please tick box(es) and return this coupon to us.

User enquiry

- Please send me an invitation to a free seminar.
 Please send me the TABS User Manual
I enclose £15 (postage and packing included)

Dealer enquiry

- Please send me details of your Dealer Plan

NAME _____

ADDRESS _____

Tel. No. _____

PCI/BI

TABS, 88 Christchurch Road, Ringwood, Hants. BH24 1DR.
Telephone: Ringwood (04254) 4751

Accounting
Business Systems
TABS

Unique in concept—the home computer that grows as you do!

The Acorn Atom

£120

plus VAT and p&p

Special features include

- * FULL SIZED KEYBOARD
- * ASSEMBLER AND BASIC
- * TOP QUALITY MOULDED CASE
- * HIGH RESOLUTION COLOUR GRAPHICS*

* optional



Also available ready-built
£150
plus VAT and p&p

● The picture shows mixed graphics and characters in three colours

The Acorn Atom is a definitive personal computer. Simple to build, simple to operate. A powerful, full facility computer with all the features you would expect. Just connect the assembled computer to any domestic TV and power source and you are ready to begin. (Power requirement: 8V at 800mA). There is an ATOM power unit available – see the coupon below.

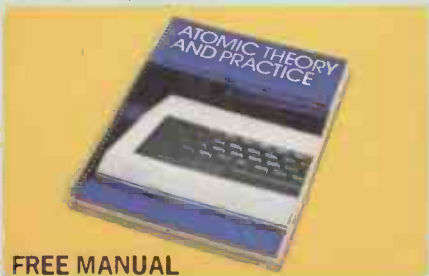

FREE MANUAL

Free with every ATOM, kit or built, is a computer manual. The first section explains and teaches you BASIC, the language that most personal computers and the ATOM operate in. The instructions are simple and learning quickly becomes a pleasure. You'll soon be writing your own programs. The second section is a reference

Your ACORN ATOM may qualify as a business expense. To order complete the coupon below and post to Acorn Computer for delivery within 28 days. Return as received within 14 days for full money refund if not completely satisfied. All components are guaranteed with full service/repair facility available.

manual giving a full description of the ATOM's facilities and how to use them. Both sections are fully illustrated with example programs.

The standard ATOM includes:
HARDWARE

- Full-sized QWERTY keyboard
- 6502 Microprocessor
- Rugged injection-moulded case
- 2K RAM
- 8K HYPER-ROM
- 23 integrated circuits and sockets
- Audio cassette interface
- UHF TV output
- Full assembly instructions

SOFTWARE

- 32-bit arithmetic ($\pm 2,000,000,000$)
- High speed execution
- 43 standard/extended BASIC commands
- Variable length strings (up to 256 characters)
- String manipulation functions
- 27 x 32 bit integer variables
- 27 additional arrays
- Random number function
- PUT and GET byte
- WAIT command for timing
- DO-UNTIL construction
- Logical operators (AND, OR, EX-OR)
- Link to machine – code routines
- PLOT commands, DRAW and MOVE

The ATOM modular concept

The ATOM has been designed to grow with you. As you build confidence and knowledge you can add more components. For instance the next stage might be to increase the ROM and RAM on the basic ATOM from 8K + 2K to 12K + 12K respectively. This will give you a direct printer drive, floating point mathematics, scientific and trigonometric functions, high resolution graphics.

From there you can expand indefinitely. Acorn have produced an enormous range of compatible PCB's which can be added to your original computer. For instance:

- A module to give red, green and blue colour signals
- Teletext VDU card (for Prestel and Ceefax information)
- An in-board connector for a communications loop interface – any number of ATOMs may be linked to each other – or to a master system with mass storage/hard copy facility
- Floppy disk controller card. For details of these and other additions write to the address below.

ACORN COMPUTER
4a Market Hill,
CAMBRIDGE CB2 3NJ

Please send me the following items:

Quantity	Item	Item price inc. VAT+p&p	TOTALS
	ATOM KIT – 8K ROM + 2K RAM (MIN)	@ £140.00	
	ATOM ASSEMBLED – 8K ROM + 2K RAM (MIN)	@ £174.50	
	ATOM KIT – 12K ROM + 12K RAM (MAX)	@ £255.00	
	ATOM ASSEMBLED – 12K ROM + 12K RAM (MAX)	@ £289.50	
	1K RAM SETS	@ £11.22	
	4K FLOATING POINT ROM (inc in 12K Version)	@ £23.30	
	PRINTER DRIVE		
	6522 VIA	@ £10.35	
	(inc in 12K version) LS244 Buffer	@ £3.17	
	MAINS POWER SUPPLY (1.3 amps)	@ £10.20	
	TOTAL		

To: Acorn Computer Ltd., 4a Market Hill, CAMBRIDGE CB2 3NJ

I enclose cheque/postal order for £ _____

Please debit my Access/Barclaycard No. _____

Signature _____

Name (Please print) _____

Address _____

Telephone No. _____

Registered No: 1403810. VAT No: 215 400 220

PC I/81

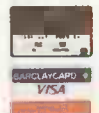

● Circle No. 153

● Circle No. 154 ►

megastor and apple

the perfect couple

1 Megabyte on  line for £1970

Plug-in compatible with Apple standard 5¼" disk drives.
Runs on Apple DOS. Includes SVA Disk 2+2 Controller Card.

Dealer enquiries
welcomed.

Apple is a trade mark of
Apple Computer Inc.
Disk 2+2 is a trade mark
of Sorrento Valley Associates.



VLASAK ELECTRONICS Ltd, Thames Building, Dedmere Road, Marlow, Bucks, SL7 1PB.
Telephone: Marlow (STD code 06284) 74789. Telex: 847008 Vlasak G

We've made it....

A 315K Disk Unit to Plug Directly Into Your Sorcerer for only £599.00 Complete



Coloured and styled to match your existing Exidy equipment this disk unit comes complete with its own internal power supply, connecting cable, software and full documentation—just plug it directly into the 50 way edge connector on your Sorcerer. Expansion is possible for up to three add on drives allowing a maximum on-line capacity of over 1 Megabyte. The single master drive will give you 315,000 bytes of formatted storage per disk.

Features include:

- ★ CP/M Operating System
- ★ Microsoft Extended Basic
- ★ Z-80 Assembler
- ★ Full Documentation
- ★ 315K Formatted Storage
- ★ Up to Three Add-On Drives
- ★ Micropolis Drive Mechanism
- ★ Complete and Ready to Run

★ ASK YOUR DEALER FOR A DEMONSTRATION

Contact Geoff Wilkinson
for further information.
Telephone: (0736) 798157

LIVEPORT
DATA PRODUCTS

The Ivory Works, St. Ives, Cornwall TR26 2HF
Telephone: (0736) 798157

Please send me further details of the FDM 180 DISK UNIT

Name _____

Address _____

Tel No. _____

Still no clear precedent in software copyright cases

SOFTWARE suppliers of all kinds will applaud recent developments in copyright protection highlighted by several recent court cases — though some civil liberty campaigners may not be so cheerful. In one case, AJ Harding (Molimerx) of Bexhill sought and had obtained, an injunction restraining Chesterfield-based Kansas City Systems from allegedly pirating tapes of a version of Basic and a monitor.

Program check

The dispute between Harding — and Microsoft — and Kansas City Systems centres around Level IV Basic which originated from the now-defunct California-based GRT Corporation. Harding and Microsoft had been marketing the program and monitor for some time when they noticed a new firm offering a Level IV Basic.

When they checked the program, which was underselling their own Level III by a considerable margin, they found, claims Anthony Harding, that it was fundamentally the same.

Kansas City's Tom Crossley disagrees. He says that there are four extra commands in Level IV added by his own programmer Laurie Shields, which make it a substantially more powerful program than Level III, and contends that in any case, he bought the rights to the program legitimately from Sorrell B Chapman — after GRT Corporation had folded.

In the event, two judges disagreed with Crossley's story. The first, Mr Justice Graham, granted Harding an *ex parte* injunction against Kansas and also made a so-called Anton Pillar order against Crossley. That meant that Harding's agent was able to go to the premises of Kansas and seize relevant evidence. He did not, though, confirm the injunction; a second judge, Mr Justice Fox, subsequently extended the injunction until the case resumes and he makes a final order.

The problem is that a final order is unlikely ever to be made. Harding and Crossley settled "at the courtroom door" — with Crossley agreeing to pay a £2,000 contribution towards Harding's costs and undertaking not to market Level IV. Crucially, there was no admission on

Crossley's part that Level IV and the monitor were obtained any other way than legitimately.

While the judge, on the one hand, seems to imply that — despite legal pundits' predictions to the contrary — a computer program falls fully within the definition of the existing Copyright Act by granting the Anton Pillar order, the point has still not been tested in law.

When, early in 1980, Microsoft and AJ Harding had noticed that Kansas City Systems were offering 'Level IV Basic' for £34 — about half of their own price of Level III, they obtained a copy of the program and found that the listing was substantially similar. That point is not in dispute, since both Harding and Kansas's Tom Crossley agree that the source of the program was the GRT Corporation.

Official agents

Microsoft and Harding were the official agents for Level III in the U.K. The loss of business was hurting, so Harding instructed his solicitor, Robert Mitchell,

(continued on next page)

The Anton Pillar Order

THE ANTON Pillar order, which instructs the person on whom it is served to allow his premises to be searched for evidence relevant to a case of alleged deliberate infringement of copyright, dates from only 1976 and has already been used "several 100 times", mostly in cases of record or radio broadcast piracy according to one estimate.

Alistair Kelman, a barrister who specialises in copyright problems, is concerned that there are inadequate safeguards on this type of order, which he describes as a "judicial invention". It has never been debated by Parliament and, points out Kelman, not even the police have the power to walk into an individual's premises "for the purpose of discovery" of evidence.

The order is so called because it was first used in the case of a German, Anton Pillar, who was a manufacturer of emulators for IBM. Unbeknownst to Pillar, British distributors of the utility were secretly copying them and distributing them at cut price. This was losing IBM a good deal of business.

To put a stop to this practice, the plaintiff Anton Pillar sought an injunction and argued, successfully, that to seize the evidence, it would be necessary to take the offenders by surprise; if averted, he argued, they would simply dispose of the evidence.

Hence, in a case of alleged infringement of copyright, the plaintiff may apply to a judge *in camera* for an *ex parte* injunction, along with an Anton Pillar order for the purposes of discovery of evidence. The two points to which Kelman objects are that:

- The order is granted on affidavit evidence. Kelman submits that the plaintiff should be cross-examined.
- The plaintiff is required to make only a "substantial undertaking" that he can compensate the defendant if the

evidence fails to yield any sign of infringed copyright. Kelman suggests that the plaintiff be required to pay in a sum of around £10,000 to the court against that eventuality.

Damages in this kind of search could be substantial: the order empowers the plaintiff's agent to take away "articles and documents which relate to the allegedly pirated work made in breach of any copyright owned by one or more of the plaintiffs" and store it in his own custody. That, indeed, is what has happened in the case of Molimerx v. Kansas City Systems.

Since it is the issue of copyright which is at stake, it is

(continued on next page)

Alistair Kelman, the barrister who specialises in copyright cases.



(continued from previous page)

to obtain at the beginning of November last, the *ex parte* injunction against Kansas City Systems — along with the Anton Pillar order which permits the plaintiff to seize relevant material.

What that meant in practice was that Harding's solicitor Robert Mitchell, Kansas City's solicitor and two other local Chesterfield solicitors were appointed officers of the court and went to Kansas's premises where they were empowered to search for, and remove, any relevant evidence. They spent most of the day there and took away two suitcases full of tapes and correspondence.

This evidence is, according to the pro-

visions of the order, to be dealt with "in accordance with the wishes of the parties concerned" when, and if, a final order is made. That is now unlikely to happen.

Both parties

That seems to suit both parties concerned. As Crossley says: "Put it this way: I've sold 150 of those programs at £34 a time", so whether or not he bought the suite in good faith from an ex-GRT employee by the name of Sorrell B Chapman in late 1979 is not really the point at issue.

Meanwhile, the software copyright laws are being bypassed by the police in favour of conspiracy. In the case of Graham

Dorian Software, police are investigating the alleged theft and dishonest handling of software owned by the U.S. firm. The firm's U.K. chief Paul Joyce has said that he "will see through to the end" the alleged theft of some of Dorian's source codes.

A third case involves Compshop which is alleged to have copied the design of the Pet Toolkit by its official British distributors Zynar, and marketed it at cut-price. Zynar wrote to Compshop implying the possibility of obtaining an injunction, but Compshop promptly gave Zynar the required undertaking to cease marketing the device: so it appears that the law of copyright with respect to firmware also has yet to be tested.

(continued from previous page)

curious that the plaintiff should be given the *de facto* power of adjudicating what is, or is not, infringing. He is also allowed to inspect and photograph accounts and ledgers and mailing lists, all of which may contain perfectly legitimate transactions as well as the allegedly infringing ones.

Some may argue that the threat to civil liberties implied by the Anton Pillar order are more illusory and theoretical than real, since most of the people in software know the game and will give way when confronted with the reality of their competitor's solicitor walking through the door with what amounts to a search warrant.

They would be wrong. By way of example, the British Photographic Society, which has seized on the order and vigorously exploited it to pursue record and radio pirates, has shown some extraordinary misjudgments; we have already seen the unedifying sight of a butterfly being

crushed on a wheel in the case of a young "trader", Richard Piggott-Sims, whose entire collection of nearly 500 radio concert tapes was taken away by an "officer of the court".

He was not using them merely for gain — he is only 17 years old — but swapping them for like tapes with pen-friends in the U.S. France and West Germany. Although the judge agreed BPI's submission on a point of law that Sims-Piggott was in breach of the Performers Act 1958 by "trading by way of barter", he was impressed by the young man's "sincerity, musical ability and technical skill" and ruled that he was doing it for "private pleasure not personal gain", and that these pleasures would not interfere with BPI's commercial interests.

One can easily imagine just such circumstances arising in the case of software tapes. Many people already copy tapes without or with modifications; a user group copying session could very well find itself the subject of such an order. M

CODIFIED COMPUTER SYSTEMS

supply **British**  Micro computer systems, S100 IEEE cards and peripherals in London

Codified Computer Systems 15 Newington Green, London N16 Telephone 01-254 7419

In delightful Milton Keynes in beautiful Buckinghamshire a near genius, who sleeps too little and smokes too much, realised the obvious and designed the following set of S100 cards to IEEE timing specs. The brand is *Interactive*. The cards work well and we regret that not only is the chip count low (giving greater reliability and proving good design), but also there are no cut tracks or free soldered wire jumpers.

Z80 CPU	S100 4 MHz CPU card with remarkably few chips. A & T. £105.00
FDC	1791 (not unnecessarily DMA) floppy disc controller to handle any combination of 8" or 5" drives at single or double density. A & T. £198.00
16K SRAM	16K static RAM card using 2114's, (we look forward to the Mark II with 24 bit addressing). A & T. £198.00
SMBC	An S100 single band computer with Z80A, 1K RAM, up to 16K ROM, 2 RS232 (or 20mA) serial I/O and 4 channel counter/timer/vector interrupt. A & T. £235.00
PCI	Process control interface D/A, A/D 8 channels — output relay isolated, input opto-isolated. A & T. £235.00
PS	Complete S100 power supply on a card (12 amps @ 8 volts) plus power for any two drives A & T £155.00

If you convince us that you have the experience to put a kit together we will supply one at 20% off.

The Codified floppy disc box

contains two DRI (made in Crewe) 7200 double-sided 8" drives giving 1.9mbytes at double density. There is room for two more inside. It is made of wood (genuine chipboard faced in oak veneer) by dedicated British workmen in Tottenham, and finished in tough acrylic varnish. It is supplied with 50 way connector, power supply and lead, mains filter (of course), illuminated on/off switch, fuses and large fan to BS3456. Price £1150.00

3 Systems, Software, Peripherals, Advice and Consultancy

A complete CP/M (TM Digital Research) operated system based upon these components with 8" DS, DD Disc storage, VDU and printer will cost about £4,200. We can reduce the price by taking off luxuries e.g. reducing the disc capacity. Example — the "Polaris" Skyline system (made in the UK) 32k would cost £1,925 with discs.

Business software and a fine word processing system is available (written in Yorkshire) for those who need a simple but expandable solution to their problems. CODASYL standard database software is now available and an electronic mail package is imminent.

Consultancy on matters to which we can claim expertise is available. In order to eliminate bias we must refuse to sell our products to a client for a year. If, in our opinion as consultants, Interactive based systems fit the requirements, they will have to be bought from another dealer.

The DAI personal computer with its unparalleled graphics facility at £900, is held in stock. Ring us to arrange a demonstration.

VAT at 15% should be added to your order totals.

• Circle No. 156

WordPro 4 with 8032 Pet can rival dedicated WP systems

WordPro 4 is the latest word-processing package from Professional Software designed to run on the new 80-column screen Commodore Pet. Nick Hampshire delivers his verdict.

WRITTEN in 6502 machine code, WordPro is, like its predecessors WordPro 1, 2 and 3, a very professional package.

The combination of improvements incorporated in the latest version and the new hardware make the Pet a very attractive proposition for serious word processing. For less than £3,500, the 8032 Pet with a one megabyte 8050 disc drive and daisywheel printer, running WordPro 4, rivals many systems costing more than four times the price.

The system required for running WordPro 4 is an 8032 Pet with either an 8050 or a 3032 with DOS 2.4 upgrade ROMs. The printer can vary from a Commodore 3032 tractor printer to the most expensive daisywheel; output can be specified by the software for either a CBM printer, NEC Spinwriter or an ASCII printer.

Suitable interface

If a Spinwriter or ASCII printer are used, a suitable interface unit will be required to convert the output of the Pet IEE 488 port into serial RS232 form. Multiple key-station system can be configured easily using a device like the MuPet which allows up to eight Pets to access a single disc drive and printer — an ideal proposition for the larger office.

The software is supplied on disc together with a 128-page manual in an attractively-presented ring binder. Also included is a protection ROM which prevents the software from being run on any machine not fitted with the ROM. The protection ROM is mounted in one of the two spare sockets provided within the machine, and can be fitted very easily by user or Commodore dealer.

The documentation is a considerable improvement on that provided with earlier versions of WordPro and is, by general standards of documentation, reasonably good. Designed as a combination of reference manual and self-teaching course with lessons and exercises, each function is clearly explained with examples.

Function sections

The manual has been divided into sections each describing increasingly complex functions — a good idea as it allows WordPro 4 to be used for the majority of simple operations after a minimum of reading. Understanding of the more advanced functions can then be achieved



while using the machine for every-day word-processing work. In my opinion, the average typist will be able to use this word processor after an hour or so of reading the manual and typing the machine.

To help the user understand the various operations, there are several sample text files included on the disc, which will resolve many questions. There is no index in the manual which is unfortunate. There is, however, a reasonably good table of contents which to some extent makes up for this omission.

First procedures

The first procedures to be executed when the program is loaded and run, are to set-up the system parameters. They are; first to determine the size of the main text area, the memory available for storage of text within the processor is divided into two sections, main text and extra text with a total combined size of 169 screen lines.

Main text can be between 85 and 146 screen lines long — each screen line is 80 characters — and is used for entry of the text file being worked on. Extra text memory is principally used to store variables and blocks of text which are to be dynamically inserted into the main text area, it can be between 23 and 84 lines.

The next parameter required is the printer device number which is determined by the hardware in the printer or interface and is usually set to four. Also required is the printer type — CBM, ASCII, or Spinwriter — again, the choice is dependent on the system configuration of the hardware. Lastly, the disc drive device number is required which is set in hardware and is usually device eight.

Having entered the system parameters, the word processor is ready. The screen will be blank except for the top line which is used to display the status, current command mode and line and column position of the cursor. Text can be entered straight from the keyboard, all the cursor-control and editing keys function as normal.

Control key

Certain keys have been assigned special functions; the most important is the OFF/RVS key which, under the word processor, functions as a control key and is used to access all the control characters used.

Single-character insertion and deletion can be done with the INST/DEL key which can also be used to insert or delete

(continued on next page)

(continued from previous page)

complete lines of text by depressing the control key. If you want to insert a few sentences within a block of text, the insert mode can be used, which is initiated by pressing shift and control. Each time you press a key, the text in front of the cursor is pushed forward one character and the character just entered inserted.

The principal feature of word processors is their ability to format the output text which is done in WordPro 4 by using format control lines within the text. There are 21 format commands — in table 1 — which give the user a very wide control over how the text will be printed.

A string of format commands is always preceded by a check-mark generated by

pressing the control key, then the back-slash key. The format commands consist of two characters followed by a numeric variable and are separated from each other by a colon.

A typical pair of formatting commands are those which set the text margins; "rm70" will set the right margin for printing at column 70 on the printer and "lm10" will set the left margin at column 10. When the text is printed, it will be a maximum of 60 characters wide starting at column 10 and ending at column 70.

The paging-format commands allow the user to set the length of each page and the number of lines to be printed on the page. The appearance of the printed text can be improved by commands such as "on" which centres a word or sentence on the page. "Ju", the justify command, converts the normal ragged right margin of typed text into a straight line by padding the line with extra spaces.

Once the text has been entered, together with the format commands, it can be output to either the screen or a printer in its formatted form. By outputting to the screen first, the formatting of the text can be checked before outputting the final copy to paper, thus saving paper.

Principal new feature

Outputting the formatted text to the screen is the principal new feature of WordPro 4 and has been made possible by the introduction of the 80-column screen 8032 Pet. The output can be either for a single-page or a multi-page continuous document — using paging and automatic page numbering and heading-format commands — and can be either for a single copy or multiple copies — up to 255.

The quality and type of output depends very much on the printer used. With a CBM printer, format commands can be used to produce enhanced characters, but with a daisywheel format commands can give underlining and up to 10 special characters, e.g., the pound sign, £.

File-mode saving

Any text entered into the machine can be saved on to disc by setting the machine into the file mode, which is accomplished by pressing the shift and CLR/HOME key. The status line will prompt whether you want to recall, memorise or insert. To save the text, press 'm' for memorise, then, when prompted, enter the drive number and the file name.

To load a file from disc, load the directory — press control and the drive number — put the cursor in front of the file name to load, enter the file mode and press the back-slash key and return — the desired text file will then be loaded.

To aid the use of discs, all the disc-drive commands are available to the user allowing discs to be initialised, formatted, copied, etc., by the user when required, without affecting the current text entry.

WordPro 4 offers a range of advanced

Summaries			
Summary of <CONTROL> functions			
Name	Enter by	Use	Cancel
Append function	<CONTROL> a	Append lines from extra text	yes
Print variable block	<CONTROL> b	Put a variable block on screen	no
Clear tab	<CONTROL> c	Clear tab at cursor position	no
Delete	<CONTROL> d	Delete words and sentences	yes
Erase	<CONTROL> e	a = erase all r = erase remainder l = erase line	yes
Find	<CONTROL> f	search for a given string	yes
Goto	<CONTROL> g	Go to a specified line number	yes
Hunt	<CONTROL> h	Re-start a local find function	no
Fill variable blocks	<CONTROL> i	Fill in variable blocks	no
Clear all tabs	<CONTROL> k	Clear off all the tabs	no
Duplicate lines	<CONTROL> l	Duplicate the range of lines	no
Modify	<CONTROL> m	Modify search-replace strings	yes
Numeric mode	<CONTROL> n	Turn on or off numeric mode	no
Output	<CONTROL> o	Enters the output function	yes
Range	<CONTROL> r	Sets a range of lines	no
Set tab	<CONTROL> s	Sets a tab at cursor position	no
Transfer	<CONTROL> t	Transfer the range of lines	no
Variable characters	<CONTROL> v	Appends groups of characters	yes
Extra text	<CONTROL> x	Switches in and out of extra text	no
Delimiter	<CONTROL> z	Enters a delimiter for list data	no
Global copy	<CONTROL> *	Copies files in a document	yes
Send disc	<CONTROL> .	Send a command to the disc drive	yes
Read error channel	<CONTROL> ,	Read the error channel	no
Special character	<CONTROL> +	Enter a special character	yes
Underline	<CONTROL>	Turn on	no
Hyphen	<CONTROL> -	Turn off underline	no
Find variable block	<CONTROL> TAB	Enter a variable block — go to it	no
Empty a variable	<CONTROL> ARROW UP	Delete the contents of variable block	yes
Home data	<CONTROL> HOME	Clear data pointer to home position	yes
Re-start	<CONTROL> <SHIFT> STOP	Re-start program	no
Directory	<CONTROL> 0	Drive #0 directory	no
	<CONTROL> 1	Drive #1 directory	no
	<CONTROL> 2	Both directories	no
Re-start global find	<CONTROL> CSRS	Re-start a global find function	no
Search and replace	<CONTROL> @	Enter search and replace function	yes
Check mark	<CONTROL> /	Enter a check mark on the screen	no
Line delete	<CONTROL> DEL	Delete a full line	no
Line insert	<CONTROL> <SHIFT> DEL	Insert a full line	no
Other functions			
Insert mode	<SHIFT> <CONTROL>	Enter/exit insert mode	N/A

Summaries			
Summary of formatting commands.			
Com-mand	Name	Para-meters	De-fault
cm	Comment	—	—
cn	Centring	l = on, 0 = off	off
fp	Forced paging	none = immediate 1—255 = conditional	—
ft	Create page footer	—	—
hd	Create page header	—	—
hl	Head left margin	1—163	lm
hr	Head right margin	2—164	rm
ju	Justification	l = on, 0 = off	off
lf	Send line feed to printer	l = on, 0 = off	off
lm	Left margin	1—163	5
ln	Do a specified number of line feeds	1—255	—
ma	Margin release	1—163	—
nx	Link next file	filename	—
p#	Set page number	2—254	1
pg	Set paging	Less than pp	—
pp	Set printer page	Page Length	—
pt	Set pitch	10 = 10 Pitch 12 = 12 Pitch	10
ra	Right alignment	l = on, 0 = off	off
rm	Right margin	2—164	75
sp	Set line spacing	1, 2, 3	1
vp	Vertical Positioning	1—pp	0

editing features, such as the ability to move blocks of text within a file or search for and replace every occurrence of a particular character, word or sentence, with another entry. The search-and-replace facility is invaluable for updating text files and the search-without-replace mode could prove very useful in the compilation of indices.

Inputting text can be facilitated by tabs which can be set at any position within the 80-character screen width; as many tabs as required can be set. Once a tab has been set, pressing the tab key will move the cursor to the next tab position.

Numerical entry

Entry of numbers in column form is made easier by setting the machine into the numerical entry mode which, in conjunction with tabs set for each column of numbers, allows the right-justification of all numerical columns by placing the numbers to the left of the cursor.

To facilitate the production of standard letters, WordPro 4 incorporates an area of extra text memory. In that text area, one can store variable blocks of text for insertion into a standard letter. It might contain a series of names to personalise and replace the normal "Dear Sir" of standard letters.

The standard letter or piece of text in which variable blocks are inserted is stored in the main text area and the position of the variable designated by a control b character. In the output mode,

the word processor can be set to insert the variable text into the standard letter automatically, print it, and then insert the next item of variable text and so on until a complete set of letters has been produced — each identical except for the blocks of variable text.

Full formatting

That feature, combined with the very neat output possible with full formatting and justification on a word processor, plus the fact that each letter is typed individually, will increase greatly the response from direct mail shots and replies to advertising enquiries.

If the word processor is to be used for writing lengthy documents, the global command feature of WordPro 4 will prove invaluable. Global commands mean that one can link files together. Each file on disc has a maximum length of about three single-spaced A4 pages, thus a document of about 100 pages will require more than 30 disc files. By linking each of them together, the whole document can be printed-out without having to load each file individually.

Page headers

Files are linked to each other by having the last line of a file with the command nx: followed by the file name which is to be loaded next. The format commands are carried from one file to the next and thus once defined, need not be re-defined for each file unless they are to be changed.

That means that page headers and page-numbering format commands will continue in the correct sequence across different text files. One can print not only an entire file in the global mode but one can also search or search and replace strings throughout the document.

Conclusions

- WordPro 4 is in my opinion an excellent piece of software, both user-friendly and apparently very robust.
- Mistakes may ruin text but have no effect on the program.
- One thing which particularly pleased me as a user of the previous versions of WordPro is that my text files generated on those old versions can still be used on WordPro 4, although they require the addition of new format commands to take full advantage of the extra features available.
- It may sound obvious that files should be compatible between different versions of a software package — however, that is regrettably not always so.
- For the programmer, the file structures are explained fully in an appendix which offers the user the potential capability of integrating WordPro 4 with other applications packages like a mailing list.
- A word-processing system based on the package together with an 8032 Pet and an 8050 disc drive plus a reasonably good daisywheel printer such as a Spinwriter seems to be a good investment for any business.

Memories

2114-300ns	1k × 4 SRAM	2.25
4116-200ns	16k × 1 DRAM	2.61
2708-450ns	1k × 8 EPROM	3.60
2516-450ns	2k × 8 EPROM	7.92
2716-450ns	2k × 8 EPROM	7.92
2532-450ns	4k × 8 EPROM	23.40

Please add 50 pence for postage and VAT.

Send SAE for price list.

STRUTT LTD

ELECTRONIC COMPONENT DISTRIBUTORS
MANUFACTURERS & SUB CONTRACTORS to the ELECTRONIC INDUSTRY.

3c, BARLEY MARKET STREET,
TAVISTOCK,
DEVON, ENGLAND, PL19 0JF.
Tel: TAVISTOCK (0822) 5439/5548
Telex: 45263

PETDOS

(as reviewed in this issue)

... is now available to complete the equation:

PET + DOS = Minicomputer

The PET Diskette Operating System — for 32K PET + COMPU/THINK hardware — provides production capabilities for:—

- * Stand-alone programs
 - * DOS-supported program applications
 - * Overlays
 - * BASIC/DISKMON—compatible assembler routines
- ... all those good ideas appearing regularly in Practical Computing, in The PET Revealed, etc. — plus all of your own — can readily be put into practice.
- SCDS PETDOS is NOT just a 6502 Assembler, but a full Disc Operating System, offering:
- * Many (fully documented) System Calls for frequently required functions
 - * Concurrent access to 16 files at any one time
 - * Easy access (sequential, random) either PHYSICALLY (track/sector) — or LOGICALLY (record/byte)
 - * Access to full 64K of core for stand-alone software
 - * 10 fundamental Utilities providing a complete software development environment
 - * Integrated DEBUG for program testing under DOS
 - * DISKMON compatibility — making data accessible to both DOS and BASIC
 - * Standardisation at both assembler and operational levels to ensure future compatibility
 - * Proven and tested software — a firm basis for your own development

SCDS PETDOS is available to solve your problems at a cost of £115 (excl. VAT), from:

SCDS,

27, St. Martin's Drive, Walton-on-Thames, Surrey, KT12 3BW.

(The above purchase price includes the full (180+ page) System manual.

When ordering please specify SINGLE or DOUBLE density Diskette AND New/Old ROM machine or Upgrade. A full spec. sheet is available — price 95p.

routine is used, one may be surprised to find that displayed on the left-hand base of the screen is a very poor artist's impression of a skyscraper complete with arrow at the base pointing to the underground carpark. It becomes obvious that the arrow points really to the last line of entry, which in this case is obviously nothing. The skyscraper is, in fact, constantly indicating free memory so that as it grows taller and nearer the top of the screen, one can see how free memory is being used.

Memory monitor

Each time another floor is added, there is 1K less memory available. As there is 16K available at the start, there is a great deal of text editor to fill. Finally, when full, a message "BUFFER FULL" is displayed. The skyscraper display is certainly a novel way of monitoring buffer-free memory.

Text may be scrolled-up or down the screen and deleting lines or inserting a new line at any point is simplicity itself. A repeat key would have been a useful feature and it might perhaps be provided in a future upgrade. One useful convention throughout the system is the cancellation of any line of input by pressing 'RVS'. The use of line numbers would be useful in defining portions to be deleted, etc. Apart from that, all the frills one could wish for are supplied with simple instructions.

The more interesting and unusual are a find instruction which will locate occurrences of a quoted string; a repeat instruction which will repeat a section of defined text; a multi-line delete function; a change facility which will, for example, change label names throughout the source text, etc.

Insert facility

Possibly, the most important could be an approximation to a macro facility referred to in SCDS PetDOS as the insert facility. It enables routines already written, tested and in a text file to be called whenever required. Such routines may be used in a final program exactly where required in the text. It also provides the possibility of assembling programs up to the full limit of RAM.

One discipline which must be acquired

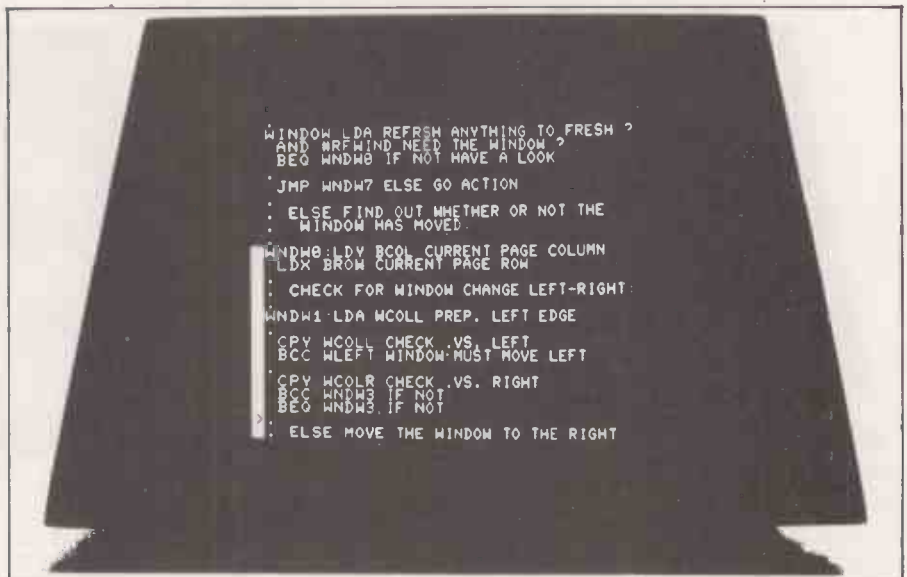

is that of putting a blank space before each opcode entered, while putting a label in the first available column. After a short time, one grows used to that form of entry. Apart from that, the form of entry is as for other editors.

There are two ways of exiting from EDIT. The first is by entering :E. which will update the file on the previously-specified disc, or if not specified, on the disc from which the text was first entered. The alternative is :0. Writing time is approximately five seconds per 2K for a double-density system.

Important feature

One of the most important features of a complex program is that it should follow logical and simple conventions. Having to check constantly in the manual is both time-consuming and frustrating. This program follows clear logic. Perhaps one of the best illustrations of that is when addressing the assembler. The instruction is:

```
UNISAM FILENAME/1:Dd,FILENAME/2:
Dd,.....
```

The dotted line is included to represent up to a further three filenames making FILENAME/5:Dd the last possible. FILENAME/1 refers to the source text filename which will later be suffixed /TXT. FILENAME/2 refers to the DOS-assembled version which is normally known as /ABS or absolute. FILE-

NAME/3 refers to the print filename later to be suffixed /PRT and the filenames 4 and 5 refer to files concerning labels and entry points which will be used by advanced programmers.

In each case, the small 'd' refers to the device of the filename concerned. The fourth and fifth filename will be omitted frequently, but so too may be the second and third. Each file will be stored on disc with a four-digit suffix denoting type and preventing accidental overwriting.

If the only filename entered is the text filename, no file will be created, but the routine will continue for the purpose of exposing assembly errors. There are many more options which all make for ease of use and the minimum of typed input.

Symbol table

The assembler symbol table is held in core and there is, therefore, a limit of 928 symbols available. That seems more than adequate for any foreseeable situation. For the professional coffee drinkers of this world, new excuses will be necessary to pursue their addiction. A two-pass assembly and creation of print file takes about one minute per 1,000 bytes of finished machine code. Clearly, the content of the text file can greatly affect the assembly speed, but tests were made

(continued on next page)

PAGE: 2 - UNISAM 3.2 (08SEP80) CODESET: 6 5 0 2 MICRO - TRIAL/TXT	
1.	0401 * = \$0401
2.	0401 A200 TRIAL LDX #0
3.	0403 A9A0 LDA #\$A0
4.	0405 9D0080 LOOP1 STA \$8000,X
5.	0408 9D0081 STA \$8100,X
6.	040B 9D0082 STA \$8200,X
7.	040E 9D0083 STA \$8300,X
8.	0411 CA DEX
9.	0412 D0F1 BNE LOOP1
10.	0414 60 RTS
11.	0415 0401 .END TRIAL
-NO- ERRORS, 2 SYMBOLS.	

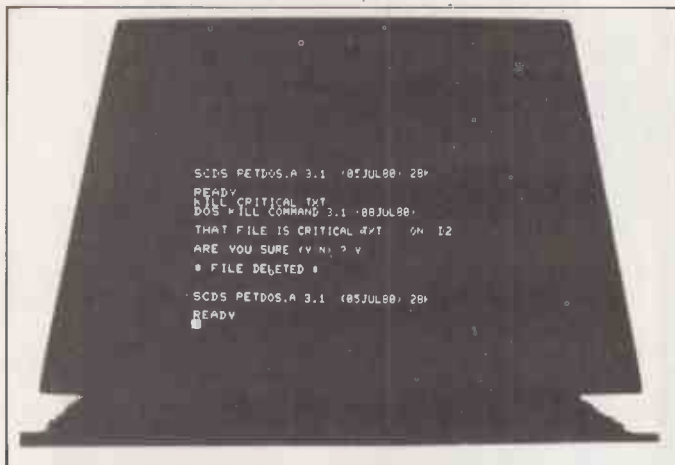

(continued from previous page)

on what might be considered a typical assembly using the insert facility which slows the assembly process to some extent. Thus Microchess could be assembled in approximately eight minutes.

However, the absolute file is not the final .GO-type program and one might be forgiven for wondering why. Apparently, one reason is that of space. To put both UNISAM and MAKEGO together would reduce the number of symbols available, and remember, the program is capable of creating machine-code programs for use anywhere in RAM with a large symbol table available. It will be run frequently under its own DOS. In these circumstances, the MAKEGO facility is superfluous. It is a very powerful system which gives many advanced options. In any case the time required to MAKEGO is only a further 20 seconds per 1,000 bytes.

Reconciliation error

It is possible that some will feel that insufficient error messages are used for the assembly process. Indeed one of the seven provided, reconciliation error, is difficult to understand. When a label address is used on pass one, and prior to defining its address, which will naturally be known on pass two, three bytes will be reserved. However, if page zero is the area of addressing, only two bytes will be required and the assembler flags the error. Conventions exist to overcome the problem, but when first encountered, the problem may be difficult to diagnose.

It might, too, be helpful to modify some of the error messages; LDA # 0F and LDA (\$00),X are both expression errors. We feel, as they are different types of error, they require different messages to describe them. A branch out of range is also flagged as an expression error which is clearly not the case. Nevertheless, errors are flagged and it could well be that some of these points are expressions of personal preference more than anything else.

Following successful assembly, it is likely that programs just written will be tested. That may be done without the use of the debug routine, but is unwise unless

very short and almost certain to be correct. If programs have been written for use in areas between \$1A00 and \$7FFF, they may be tested without modification. Those lower than these locations will encounter the PetDOS working area and a modified file will need locations assembling with the lowest RAM address occupying \$1A00. Later when correct, all that will be required is to alter the load address.

Assuming, therefore, that the debug is required, it must be called up with the '#' followed by the return key. For a start, all the registers may be examined by pressing 'R', but the main use will be to set break points in the newly-written program. That is done by pressing 'M' followed by the required address. To increment by one place, press 'HOM'. A modification to the program is possible by amending as though through the monitor.

Providing only break points are required, it is straightforward. Pressing 'E' will return to DOS where the program may now be run, a segment at a time. We did not find the debug a very powerful tool as it is somewhat slow to implement in that way, but it is a feature of testing programs written in machine code. As with all programming it pays to be right first time; there is no easy alternative.

Page length

Unfortunately, we were able to test this routine on only two types of printer. One, the Commodore 3022 using the IEEE 488 port, did not work satisfactorily. The printout was understandable but not well formatted. On the other hand the Texas 810 printer, using the RS232 port and ADA 1200 interface, performed well. Undoubtedly, the performance on the Pet printer needs improvement and is the only point we found short of perfect.

When printing on the Texas printer, the page length is set to 66 lines of which print is displayed on 60. The width required is 80 columns although we understand that a modification would be possible for 40-column printers. Furthermore, it might be possible to have a different number of lines per page if there was a demand. That could be set each time in response to a

question through the screen. The layout is perfect and line numbers omitted from the screen display on edit are now shown. When printing-out a large program with the INSERT facility in use, each INSERT will still be printed in full and not just by reference as one might expect.

Important utilities are available such as BACKUP which copies discs through DOS. Surprisingly, the normal Diskmon DISKCOPY routine will not copy discs. KILL is the equivalent of Diskmon 'Erase' and CAT will display the directory to the screen. In this case, more information is available than when calling \$DIR on Diskmon. NEWDRIVE will modify the scope of search for files and may be used to protect an area containing files of the same name.

The standard of documentation is exceptionally high. All too often, a good program receives insufficient attention in that area. Apart from approximately 160 full pages of instructions, the manual has been conceived by a perfectionist and professional. If there is any criticism at all, it must be that as with all perfectionists, they tend to allow for every situation. That can mean that although every situation seems to be covered in the manual, one sometimes has to search for the answer. That situation is preferable as it is most annoying when answers are implied rather than detailed. The price of the package is likely to be about £150.

Conclusions

- PetDOS is a thoroughly professional and well-thought-out program.
- Commands are always clear and logical throughout the software's own DOS.
- It is written totally in machine language — there are no routines in Basic.
- The assemblies are very fast and so are an excellent way to increase productivity.
- The package prints neatly to RS232-interfaced printers.
- Some improvements ought perhaps be made in its performance for printers using IEEE 488 ports.
- The instruction manual is extremely comprehensive and the package as a whole is supported by all the necessary utilities.

Apple Price List

Product Code	Description	Price (£)
HARDWARE		
A2S1016P	APPLE 16K VIDEO OUTPUT ONLY	695.00
A2M0003	DISC DRIVE WITHOUT CONTROLLER	299.00
A2M0004	DISC DRIVE WITH CONTROLLER	349.00
A2M0016	16K ADD ON RAM	69.00
CARDS & ACCESSORIES		
A2B0001	PROTOTYPE/HOBBY CARD	15.00
A2B0002	PARALLEL PRINTER INTERFACE CARD	104.00
A2B0003	COMMUNICATIONS CARD	130.00
A2B0005	HIGH SPEED SERIAL INTERFACE CARD	113.00
A2B0006	PASCAL LANGUAGE SYSTEM	299.00
A2B0007	CENTRONICS CARD	130.00
A2B0009	APPLESOFT FIRMWARE CARD	116.00
A2B0010	INTEGER CARD	116.00
MHP-X003	MOUNTAIN HARDWARE CLOCK/CALENDAR CARD	168.00
MHP-X006	MOUNTAIN HARDWARE SUPERTALKER	179.00
MHP-X007	MOUNTAIN HARDWARE ROM PLUS BOARD	127.89
MHP-X015	MOUNTAIN HARDWARE ROMWRITER	106.05
A2B0017	EUROCOLOUR CARD	113.00
E2B101	APPLE BLACK & WHITE MODULATOR	14.00
A1-02	A1-02 DATA ACQUISITION CARD	192.00
10-5-16	ALF MUSIC SYNTHESIZER CARD	103.00
10-5-17	ALF TIMING MODE INPUT BOARD	14.00
13-3-2	ALF ALBUM MUSIC DISKETTE NUMBER ONE	12.00
13-3-4	ALF ALBUM MUSIC DISKETTE NUMBER TWO	12.00
13-5-5	ALF ALBUM MUSIC DISKETTE CHRISTMAS	12.00
A2M0015	HEURISTICS SPEECH LAB	122.00
A2M0019	PROGRAMMERS AID 1	27.00
A2M0027	AUTO START ROM PACK	38.00
A2M0029	GRAPHICS TABLET	462.00
E2B104	HEURISTICS CONTROLLER 70	57.00
E2B105	HEURISTICS SPEECHLINK 2000	168.00
E2B107	IEEE INTERFACE	212.00
SOFTWARE		
A2D0005	CONTRIBUTED SOFTWARE VOLS 3-5	60.00
A2D0006	CONTRIBUTED SOFTWARE VOLS 1-2	27.00
A2D0009	MICROCHESS 2.0 CHESS DISK	15.00
A2D0010	DISC UTILITY PACK	15.00
A2D0012	APPLE BUSINESS CONTROLLER PROGRAM	340.00
A2D0013	APPLE POST PROGRAM	27.00
A2D0018	APPLE BOWLING DISKETTE	9.00
A2D0025	APPLE CASHIER PROGRAM	194.00
A2D0026	APPLE WORD PROCESSING PROGRAM	42.00
A2T0013	MICROCHESS 2.0 CHESS CASSETTE	15.00
E2D001	VISICALC DISC & BOOK COMPLETE	125.00

Product Code	Description	Price (£)
DOCUMENTATION		
A2L001A	APPLE II REFERENCE MANUAL	11.00
A2L0002	6502 HARDWARE MANUAL	9.00
A2L0003	6502 SOFTWARE MANUAL	9.00
A2L0005	APPLE II BASIC PROGRAM MANUAL	6.00
A2L0006	APPLE II REFERENCE MANUAL	6.00
A2L0012	DOS 3.2 MANUAL	6.00
A2L0018	APPLE II BASIC TUTORIAL MANUAL	6.00
GENERAL ACCESSORIES		
A2D0000	(10) BLANK APPLE DISCETTES	32.40
A2M0009	VINYL CARRYING CASE	16.00
AD/LB	MINI DISC LIBRARY BOX	2.64
MD5172	DISCOFLEX FILING CASE-MINI	12.64
APP1	APPLE DESK TWO TIER	145.00
APP2	PRINTER TABLE	92.00
APPLETEL	APPLETEL SYSTEM	595.00
DUST/APP	DUSTCOVER FOR APPLE II	9.95
E2B013	APPLEJUICE RESERVE POWER SUPPLY	157.00
PRINTERS & ACCESSORIES		
A2M0034	SILENTYPE 80 COLUMN GRAPHICS PRINTER	349.00
A2C0001	10 ROLLS OF THERMAL PAPER FOR SILENTYPE PRINTER	28.00
CENT.737	CENTRONICS 737 PRINTER C/W ADAPTOR	450.00
TIGER/G	PAPER TIGER PRINTER WITH GRAPHICS OPTION	598.00
TIGER/C	CONNECTOR CABLE FOR TIGER PRINTER	9.00
TIGER/D	GRAPHICS SOFTWARE FOR TIGER PRINTER	20.00
TIGER/P	TIGER PAPER 2,000 SHEETS 11" x 9.5" 1 PART	31.43
T1810	TEXAS OMNI 810 PRINTER	1450.00
LP5	PAPER 2000 SHEETS 11" x 15" S/PART	14.06
LP9	PAPER 3000 SHEETS 8" x 12" S/PART	14.85
VIDEO MONITORS		
VM129	12" BLACK AND WHITE VIDEO MONITOR	189.00
VM910	9" BLACK AND WHITE VIDEO MONITOR	127.00
VM906	9" HIGH RESOLUTION BLACK AND WHITE VIDEO MONITOR	148.00
VMC	CABLE FOR VIDEO MONITOR	9.00

Prices exclusive of carriage and VAT and are correct at time of going to press. Available from Apple Dealers all over the UK—for your nearest please contact Microsense Computers.

Dealer/OEM enquiries welcome.

microsense computers limited

Finway Road, Hemel Hempstead, Herts HP2 7PS
Tel (0442) 48151 and 41191
Telex: 825554 DATEFF G



SOLE UK DISTRIBUTOR

apple computer

®Apple is a trade mark of Apple Computer Inc., Cupertino, C.A., USA.



63

• Circle No. 159

Sord M223 mark II's strong suit is design and compactness

THE SORD M223 mark II is an attractively-styled microcomputer made in Japan by Sord Computer Systems Inc, and distributed in the U.K. by Midas Computer Services Ltd of 2 High Street, Steyning, Sussex. The computer is supplied with an integral keyboard, video screen, and two Teac mini-floppy disc drives.

Processing is performed by a Z-80 chip running at 4MHz, and the system has 64K of RAM. The S-100 bus is used, and three spare slots are accessible via a removable panel at the rear of the unit where users may insert their own cards. An IEEE 488 interface is optionally available using the GP-IB control board. Also at the rear of the unit are two serial I/O ports, giving RS232C connections for a printer, or to another VDU, via 25-pin D connectors.

Two DIP switches allow the setting of baud rates for data transmission between 110 and 9,600 baud. The keyboard is well constructed, and in addition to the usual alpha-numeric keys, there is a numeric keypad, a set of four user-programmable function keys, allowing eight pre-defined functions, and 11 keys which provide 22 pre-programmed functions, mostly for use with Basic systems.

Unusual feature

An unusual feature is the set of seven sense switches which light-up when depressed and provide an extra set of inputs to a program. The state of the sense switches can be monitored by the program and can be used to control the flow of the program or to aid program debugging by switching-on or off trace facilities.

Another unusual feature is the character set, which is a variant of ASCII, and includes standard upper- and lower-case characters, normal punctuation marks, a number of graphics symbols, and a set of Japanese Kana characters. The integral VDU has a green screen, and displays 24 lines of 80 characters.

For high-resolution graphics work, there is an optional facility giving 512 × 256 point resolution. It requires the addition of two boards for colour, or one board for black and white, and a TV monitor.

The power switch takes the form of a key with off, on and lock positions, allowing the machine to be locked in the power-on state. In that state, pressing the re-set key has no effect, preventing an operator from inadvertently re-setting the machine and so making it suitable for turnkey applications.

When the machine is switched-on, the user is asked to load a diskette in drive 0, and to strike any key. That initialises the disc-operating system. The screen takes a

few seconds to warm up, and displays good-quality characters. While the machine is running, there is a slight noise from a cooling fan at the rear of the unit.

The disc-operating system offers a reasonable range of commands for performing useful activities such as listing directories, initialising discs, copying

by David Martland

discs, deleting files, and so on. It is somewhat strange to be able to obtain error messages from the operating system in Japanese — the command SYSTEM/K causes all operating-system messages to be displayed using the Kana character set.

Oddly, the option does not apply to the Basic systems tested. The operating system performed satisfactorily apart from one quirk — pressing the edit key which should be done normally only in a Basic system, crashed the system.

A variety of software is available for the Sord computer, including three versions of Basic from Sord, Fortran and Cobol from Sord, and CAP MicroCobol. The Basic systems are denoted EBasic, CBasic and MBasic, which stand for extended Basic, compiled Basic, and matrix Basic respectively.

The documentation supplied with the equipment refers mostly to Basic, and

the keyboard lay-out suggests that the machine has been designed specially with Basic in mind. The only systems tested were the EBasic and CBasic systems.

For a personal computer, the instruction manual is very comprehensive, although at its price, the device might be considered more suitable for business use, and by the standards of other business equipment the documentation is not very voluminous.

The manual appears to be a translation from Japanese, is difficult to read, and in places, inaccurate. With some determination, it is possible to extract enough useful information from the manual to start the system working, but really the documentation needs completely re-writing for English-speaking buyers. An U.S. re-write is promised for the near future.

Style example

As an example of style, the following comment refers to the processor:

"The processor controls all the computer system. It is false to think the processor and the main memory are solidified. Computers cannot run more than programming by programs".

EBasic has a number of interesting features, including logical operators, timer routines, Time and Sleep, and





double-precision arithmetic. Low-resolution graphics are available using cursor control within print statements. It takes time to absorb the differences between the Sord Basic and standard Basic. LET and PRINT do not work in immediate mode which causes problems when trying to test programs interactively, but the special commands, SET and TYPE, do what is needed in that mode. It is not possible to use any other commands in immediate mode, nor can system commands be used in Basic programs, as in some other systems.

With an appropriate Basic disc loaded, the user types EBasic or CBasic to enter a Basic system. There is not a great deal of difference between the Basic systems apart from the fact that CBasic appears to compile the program before running it, while EBasic is a straightforward interpreter.

Developed programs

Developed programs can be compiled under CBasic and stored in their compiled form. Entering Basic programs is rapid, using the Basic function keys. Most commonly-used Basic keywords are available on the keys, and others can be set-up on the user-programmable OPKEYS. Available keywords are:

LEN(ATN(GOSUB	RETURN
USING	INPUT	END	THEN
LN(GOTO	TAN(PRINT
EXP(LIST	CLOSE	SAVE
DELETE	OLD	ABS(

Most of the keys cause the required text to be displayed, but the End key also terminates the current line. The rub-out key removes only single characters of the keyword, so if the wrong keyword is

typed, it is more tedious to remove it than it was to enter it.

Using the Auto instruction for automatic line numbering, programs are input very quickly. Users who already know a Basic system will probably find the keyword facility takes time to grow used to, though users with little experience of computers should find it helps a good deal. That criticism has been levelled at machines other than the Sord, but it is hardly the fault of the machine if users find it hard to forget the skills they already possess in favour of an easier method of program entry.

Syntax errors

Syntax errors are reported as they are typed, and the method of handling such errors is at first difficult to see, but in many cases allows continuation of the line by correcting the incorrect syntactic unit. Sometimes, the line up to the point of error is displayed, but not always.

Apparently, that is because part of the line has already been accepted as a valid syntactic unit. What is disturbing is that an attempt to type the whole line again correctly may fail, because the system expects the user to type only the corrections.

Nevertheless, the method prevents a large number of potential errors from being incorporated into programs. Runtime error reporting is less satisfactory, with messages of the form

```
ERROR NO 512 AT THE LINE 10
```

The user must look up the details of the error in the manual. On a disc-operating system with adequate space for a file containing the error messages, that is primitive, though not uncommon. A

worse feature is that not all errors are detected — in particular, divide by zero is not detected. Thus the program

```
10 LET X=1
20 LET Y=0
30 LET Z=X/Y
40 PRINT "DONE"
```

will print the message "DONE" without detecting the error at line 30. If the variable Z is printed-out, it will most likely have some very large value in the region of 10 raised to the power 74. An ON ERROR statement will trap that error, but it is a surprise to see such non-fatal errors slipping through without special treatment.

The system supports files, both sequential and random-access for serious processing of data held on disc storage. In other respects, the Basic performed reasonably well — but not significantly faster or slower than other Basics. CBasic is faster, but that is not apparent while developing programs because of the extra time spent compiling the program.

Conclusions

- The Sord M223 Mark II is a well-designed piece of hardware which would suit users who like the idea of having all their computer equipment contained in one box.

- However, for use as a personal computer, the price seems likely to deter all but the very affluent hobbyist.

- The machine seems to have been designed primarily to support programming in Basic, a language which is not really appropriate for many applications.

- For business use, the machine might meet competition from machines such as the Cromemco Series 3, and the provision of languages other than Basic seems essential.

- Fortran and Cobol from Sord are available, but if they are like the Basic, other systems may perhaps offer more advantages.

- However, CAP MicroCobol is available, and as a reasonably standard piece of software, the machine may prove to be a good buy using this software for business applications.

- Midas Computer Services has produced versions of the computer to run multi-access systems, and is negotiating for the CP/M operating system to be made available for the model.

- CP/M should greatly enhance the utility of the equipment by enabling a very much wider range of software of more certain quality to be run.

- The quality of the software and the documentation of the system tested did not live up to the potential of the hardware.

- The price of the Sord M223 Mark 2 is £4,250; the price of the GP-IB interface board is £348.

- The high-resolution graphics option costs about £600; the price for most Sord software is about £300 and CAP MicroCobol costs £2,000. □

THE SBC-100 is a single-board Z-80 computer manufactured by SD Systems of the U.S. whose product range includes hardware and software for complete micro-computer systems. Although based on the pre-IEEE S-100 bus, the board has been used successfully in combination with Godbout Econoram — 48K total — North Star single-density disc controller and the Vector Graphic Flashwriter II video board, so there is no great danger of becoming tied to one manufacturer. Obviously, the usual care must be taken, as when linking all pre-IEEE S-100 boards from different sources.

Also available is a 2K SD monitor which is a natural adjunct of the SBC-100. It is important to stress that the SBC-100 is not a true single-board computer in the sense that, say, either of the Nascoms are. For a start, it lacks both a keyboard and a video monitor driver. What we have is

by Andrew Stephenson

more of an embellished CPU aimed at serious-but-small systems, with these major features:

- Z-80 CPU at approximately 4 MHz;
- Z-80 four-channel counter/timer circuit (CTC);
- Synchronic/asynchronic SI/O — USART — for RS232 and 20mA loop;
- Separate parallel input and output ports — PI/O;
- 1K static RAM;
- Four sockets, for 1K/2K/4K/8K each;
- Jump-on-re-set — auto-start.

Revision B — the review machine — seems to date from summer 1978 and is, therefore, about as modern as is desirable for normal applications. It has been on the market long enough to have had the bugs removed and is readily available.

Supplied either as a kit — approximately — £155 or assembled — approximately — £197 — it is neatly constructed on a double-sided solder-masked pcb. Gold-plated edge connectors — S-100, 26-way USART and 26-way PI/O — plated-through holes, and sockets for integrated circuits, mean that mechanical reliability is likely to be good; and that, should an otherwise awkward component such as an integrated circuit fail, it can be replaced easily and without damage to the board.

Helpful tables

Of the numerous options, only ROM select — on-board-memory space allocation — and part of the auto-start address are equipped with wire-wrap headers. Other options must be selected by soldering and/or cutting of factory-pre-set printed circuit links.

To assist the user, there are numerous helpful tables in the handbook — or Operations Manual as it is somewhat grandly titled. The document is well printed but must be studied closely for there is an extraordinarily diverse choice of configurations of ROM, RAM, CTC, PI/O, USART, auto-start, not to mention the software-selected options in the CTC, PI/O and USART. There are also a few

Personalised system giving flexibility and reliability is SBC-100's best role

minor typographical errors, most of which will readily betray themselves, especially if one refers to the CTC and USART data sheets, which must be obtained separately.

Kit builders will find that assembly instructions are straightforward, if not exactly lavishly detailed. As the handbook says, the kit version is intended for those people who have had some prior experience with kit building and digital electronics. Raw beginners should keep their soldering irons away from its compact corners.

Some thought has been given to real-world applications: for example, the crystal-controlled clock runs at 2,457,600

SD monitor details not given in handbook.

- There are signs that it requires most of the RAM space from FFAC to FFFF.
- Users' stack is established at FF60. Available depth is uncertain but use of lower addresses by monitor was not apparent in tests.
- Useful addresses:
E000: entry only after re-set.
E003: normal re-entry.
E006: test if character received by USART
E009: USART character input routine.
E00C: USART character output routine.

Hz — or 4,915,200 Hz if a link is moved, although that option is offered mainly to facilitate the changing of crystal frequency, if desired. Consequently, the USART can be set accurately to all common speeds from 110 to 9,600 baud by a software command.

Power needs are satisfied by the standard S-100 lines. No current consumption figures are quoted by SDS but the unit, loaded by a 2716 monitor ROM and the RS232 link to a terminal, took 560 mA from the +8V line. The two 16V lines are used solely by the USART I/O buffers: each drives a 12V zener regulator through a 150 ohm resistor.

Thus, if no other part of the system requires either 16V line, and if no use is to be made of the serial I/O, a single +8V supply would suffice. Bearing in mind the other features, it would not be unrealistic to see the SBC-100 as the heart of one of those distributed domestic control systems so beloved of microcomputer propagandists. At least it is worth considering.

Also worth considering is the SBC-200, essentially a 4MHz version with a few modifications to accommodate forth-

coming upgrading of the SDS line, such as bank switching. A monitor is not yet officially available, but Computer Centre can provide a specially-adapted and EPROMed version of the standard monitor. Prices for the SBC-200 are around £182 for the kit or £242 assembled and tested.

All on-board memory addresses are relocatable. Furthermore, if the on-board option has been used, the SBC-100 hardware takes priority over off-board hardware, in the event of an address clash.

Useful scratchpad

The memory of 1K of static RAM — two 2114s — offers a useful scratchpad for system variables. Stand-alone operation is further simplified by the four empty ROM sockets, suitable for several kinds of popular 5V 1K, 2K, 4K and 8K ROM. The factory-fresh type option is for 2716. Although that restriction to +5V only excludes the 2708, the 2758 can be used — a little judicious re-wiring of supplies could remedy the shortcoming.

The normal procedure is, first, to define the ROM size — 1K, 2K, etc. — then to select or deselect the various sockets. RAM, too, can be deselected, as it is mirrored to fill a block as large as that defined for the ROMs and might, therefore, use an unduly large memory area. Memory-start addresses can be set to whole-ROM-size values; e.g., 2K boundaries if 2K ROMs are defined. That may seem complicated at first sight, but the handbook tables make it reasonably easy.

Auto-start jumps

Auto-start can jump to any 4K boundary but is pre-set to E000 or F000. The choice between the two is made by a plug link. The handbook says that auto-start jumps must arrive at the instructions

Address x000 = JP x003

Address x003 = IN A, (7F)

which re-set the auto-start hardware; but all that is necessary is IN A, (7F) or OUT (7F), A, so that feature is simple to implement.

For USART, the user should obtain the Intel 8251 data sheet. It has its own 26-way printed-circuit edge connector wired so that a ribbon cable to a D-25 socket results in the correct pin-out for a modem

look-alike. RS232 and 20mA loop — whose transmitter has a floating current source — operate simultaneously.

The USART baud rate is defined by a value programmed into channel 0 of the CTC, which provides the USART clock, unless the user decides otherwise and changes links. The SD monitor, incidentally, determines the correct baud rate from the duration of the start bit of the first character received after a cold re-start — usually a carriage return — and sets the USART accordingly.

Links select from a menu of asynchronous mode — pre-set; synchronic mode, with external clock; external baud-rate clock; and refinements of these. Software selects from five, six, seven or eight data bits; parity bit odd, even, or absent; one, one and a half, or two stop bits; and a few extras.

PI/O has separate 8-bit output and input, each with two handshake lines. Another 26-way connector brings out those lines, along with 0V and the regulated on-board +5V.

Output strobe

Links determine whether outputs can be switched on/off by handshake; polarity of the output strobe; whether the output strobe is cleared by handshake or by software; whether the input latch is always open or is gated by input strobe. Status bits and handshake outputs use the same control port address.

For the CTC, the user should obtain Mostek MK3882 or Zilog Z-80 CTC data sheet. It has four independent channels, each of which may be programmed to generate vectored interrupts at zero-count; divide the system clock by a specified value — up to 2^{16} ; or count external trigger inputs. Links allow for several configurations, including trigger I/O via S-100 bus and USART-originated vectored interrupts. That is a powerful circuit block which, among other possibilities, simplifies real-time clocks.

The tailor-made SD Monitor is supplied

SBC-100 allotted port numbers.

Port	Circuit block	Function
78	CTC	Channel 0 — normally supplies USART.
79	CTC	Channel 1
7A	CTC	Channel 2
7B	CTC	Channel 3
7C IN	USART	Rx Data
7C OUT	USART	Tx Data
7D IN	USART	Status
7D OUT	USART	Control
7E	PI/O	Data
7F	PI/O	Handshake: status and control; also clears auto-start hardware after Initial jump-on re-set.

on a 2716 to run from a base address of E000 and is priced at about £18.40. It offers:

- Automatic USART baud-rate selection.
- Memory functions: display block — in Hex and in ASCII, if printable; examine and change specified locations, with address increment or decrement afterwards; fill block with a given Hex code; move block; locate a given string of up to six bytes length within a given memory area; test RAM between given limits; verify, i.e., compare two blocks.
- I/O functions: read from a given port a given number of times and display the inputs; output a Hex byte to a given port a given number of times; examine and change a port — that resembles the memory-examine function.
- Program control: maintains in RAM from FFE6 to FFFF a map of all the Z-80 registers and flags, and displays it as required, say, on encountering the single breakpoint which may be set; after any single-step operation; after each register-examine order. Additional functions are go to a given address and begin execution; display sum of, and difference between, two Hex four-character values.
- Disc commands: they are of interest only to owners of SD computer systems, as they interwork with the SDS Versafloppy controller board and SBC-100 BIOS PROM at F000. They handle CP/M

boot-up, read/write from/to disc, and formatting of discs.

SDS offers good value for money where the hardware is concerned. It is soundly made, offers considerable flexibility, and is reliable: my unit has been in steady use for almost a year now and has yet to fail. Up to a point, that is all most users want to hear.

It is in its supportive documentation that SDS falls down. Every handbook of which I have studied — SBC-100, SD monitor, VDB-8024, PROM-100 — gives most of the useful information, yet spoils the effect by omitting important — even, one might say, vital — data.

For example, adventurous programmers could suffer some headaches when using the monitor, whose RAM usage is not made at all clear. The annoying fact is that most of the missing information could have been included so easily.

Attractive notion

Computer Centre says that this is because the various SD products were intended to be sold and operated together, hence the system documentation as a whole would furnish those details. Attractive though the notion is, it may not be a good idea for a manufacturer of such complex products to sell them separately without supplying complete and individually-appropriate back-up information. In the case of the SBC-100, fortunately, that should cause few problems.

Of course, that failing is by no means confined to SDS; it is a blot in the copy-book of the microcomputer industry as a whole; some manufacturers are, of course, better than others.

While on the subject of the monitor, it seems worth mentioning that the locate function appears prone to a mystery bug, in that it has been known to alter the user's stack pointer — in the register map — and occasionally corrupts the contents of low RAM — apparently below 100 Hex. However, it locates the given string, and the bug is very hard to reproduce. That is true of version 2.1; later versions may be cured.

A minor monitor idiosyncrasy is that it requires an output device line length of at least 71 characters for some functions, such as 256-byte display. That does not suit the popular 64-columns-by-16-lines size. Fortunately, there are ways round it. The rest of the functions, particularly those involving the register map, are a delight to use.

Conclusions

- To use the SBC-100 as, say, a domestic systems controller would be to undervalue the board by a wide margin.
- If a user needs a personalised system, compiled from parts individually-selected for their suitability, the SBC-100 may offer a soundly configured and reasonably-priced starting point.

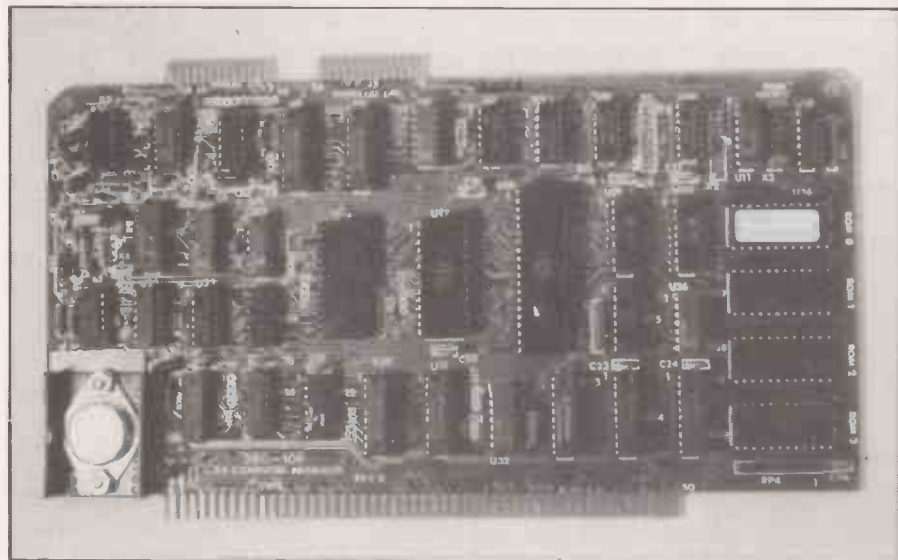

Thinking big in a world where smallness matters

Already, the Japanese are talking about capturing the power of an IBM 370 — a computer which fills a large room — on a single chip .25in. square. What are the realities behind those developments? What constrains them and how soon will such feats be realised? Peter Laurie reports.

NO SOONER has the wonderchip burst on an astonished, and in many cases, less-than-delighted world, than it promises to soar to yet more extraordinary heights of power and complexity.

It is no secret by now that the most important aspect of the new electronics is its smallness. Everything is micro — a word derived from the Greek letter omicron, which for a long time has been the scientific abbreviation for one-millionth.

Why does the smallness matter? It makes possible beautiful photographs of wonderchips sliding through eyes of needles, or of ants wrestling with whole processors, but is that all? Would not a microcomputer be just as useful — or useless — if its processor were 6in. or a 1ft. square instead of .25in.? It would indeed — but you would not be able to buy it. The reason why smallness matters is buried deep in economics and physics. To see why, we first have to look at what a chip is and how it is made.

A chip, say, a microprocessor, is simply a very great many switches which control each other in various ways. If you had the money, patience and space, you could create a device which accomplished the same things but rather more slowly from old-fashioned Post Office relays. Each switch is a metal oxide semiconductor — MOS — transistor. A transistor is so simple a thing that one does not know whether to laugh or cry that the future of the world should depend on something so apparently easily manufactured.

To make an MOS transistor and change the world, follow this simple recipe.

- Take a polished wafer of pure silicon.
- Cover it with a thin layer of silicon oxide. The easiest way to do that is to heat it in an atmosphere of oxygen.



Within a few years, it should be possible to put a complete IBM 370 on a single chip, .25in. square.

- Lay a narrow conductor of polysilicon — poly — on the oxide.
- Cut a path through the oxide at right-angles to the poly to reveal the underlying silicon.
- Heat the whole chip in an atmosphere of arsenic, antimony or phosphorous vapour so that the atoms of those elements diffuse into the exposed silicon and dope it.
- Remove, test, package and sell — figure 1.

The silicon substrate immediately under the polysilicon strip does not become doped since it is protected by the poly and the oxide from the dopant atoms. Consequently, although both poly and doped silicon — the diffusion zone — conduct electricity like wires, there is no connection between the diffused zones on

either side of the poly, until a voltage is put on the poly.

Then, by the mysteries of semiconductor, it is possible for a current to flow from the one doped area to the other giving a very economical, electrically-controlled switch. It is economical since the polysilicon gate conductor is insulated from the other two by the oxide layer and there is no easy way electrons can leak from it.

High impedance

In terms of electronic engineering, the gate has an enormously high impedance. That is the main reason why so much computer can be crammed on to so small a chip — the gates draw no current, consume no power and a device consisting of many 1,000 transistors can work without melting itself. That would not be true of the older bi-polar transistors — figure 2.

To make a useful logic gate, a few more things are required; a resistor to make an output possible. That is accomplished by putting a slightly different transistor above it — a depletion mode device — which works like a resistor when its gate is connected to its drain — figure 3.

What happens now? A voltage on the input — I/P — gate makes the lower transistor conduct and connects the output — O/P — to ground. Only a limited amount of current can flow

Figure 1.

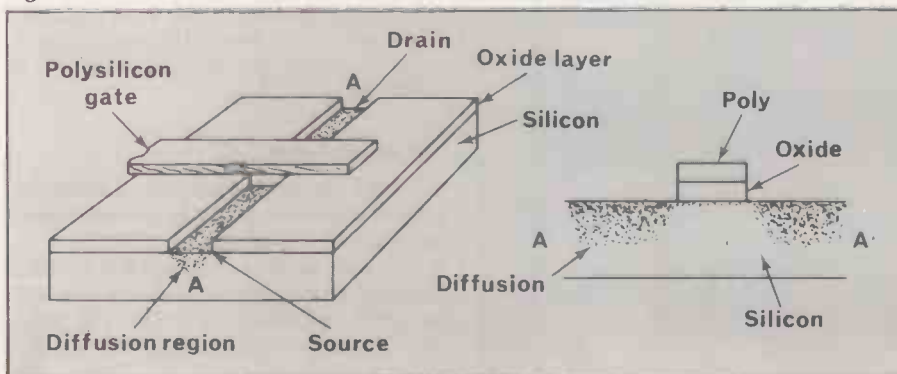

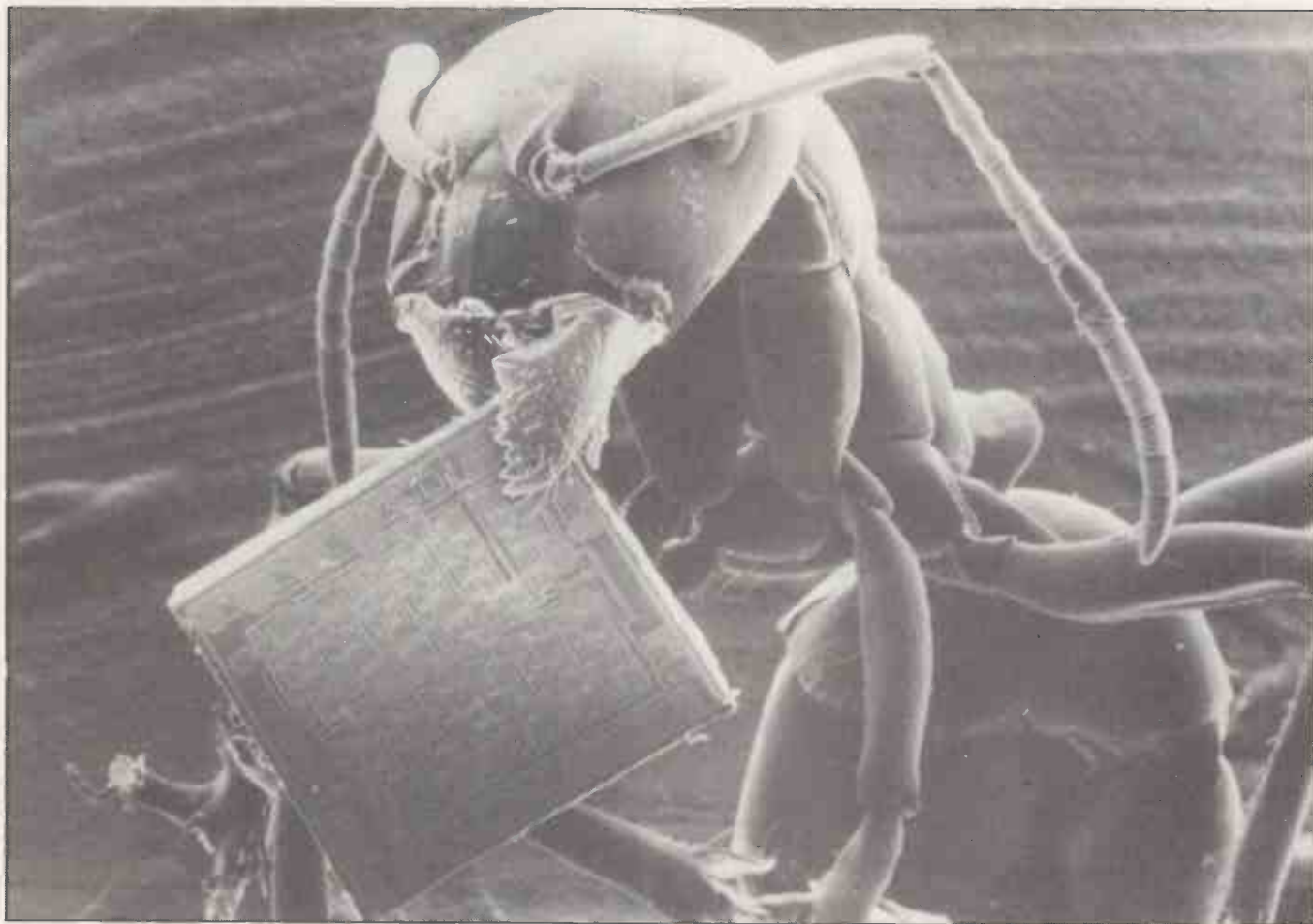

An ant carrying the IBM 370 of the future?

through the upper device — the resistor — so the output voltage falls to zero. If the gate voltage is removed, the transistor turns-off, the output is now connected only to the + supply rail and its voltage rises. We have a logic inverter which turns logic 1 to logic 0 and vice versa.

Logic gates

It is now easy to make the two basic logic gates; MAND and MOR. One more element is necessary — memory. Since the gate of a MOS transistor has such a high resistance, once a charge is put on it, it will remain for a long time which in this context means a few thousandth of a second — figure 4.

That is all ordinary dynamic RAM is — rows of transistors which are either on or off and remain that way until the processor returns a few thousandths of a second later to read the state of each memory cell and re-write it — to refresh it. Each cell of static RAM consists of two cross-connected transistors.

At any time, one is on and the other off. They are wired so that they hold each other in the state in which they were left. That is all there is to MOS technology; one conductor switches another on and off. It has the characteristic simplicity of a truly great idea.

The usefulness of a processor or a memory consisting of some 10,000s of

these transistors depends on two things: how many there are and how fast they work.

The speed of operation depends on two things: the transition time of a transistor — the time it takes to switch from on to off, or vice versa; and the time it takes to send the resulting signal to the next transistor. The conductor which connects the output of one transistor to the input of

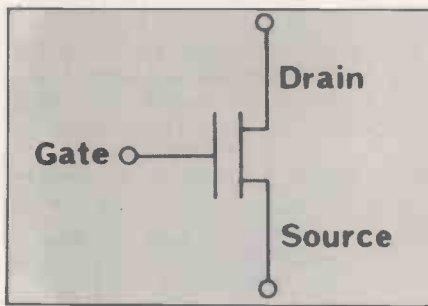

Figure 2.

the next is also a capacitor, and, like any capacitor, it takes a certain amount of time and energy to charge or discharge it.

Perhaps surprisingly, the main limitation to the speed of semiconductor devices is not so much the switching speed of the devices, but the time penalty in charging inter-transistor connectors. The shorter and narrower those lines are, the quicker they operate. That also holds true for the transistors themselves — the

smaller they are, the more quickly they switch.

So, a most important measure of the performance of a device is the size and packing of the transistors in it. A convenient measure is the line width — the widths of the various strips that constitute the devices. In 1978, the smallest width used in production was about $6\ \mu\text{m}$ — the paper on which *Practical Computing* is printed would allow parallel conductors in its thickness — and that is what we now have in microcomputers.

Silicon area

The process of putting various conductors and devices on to silicon is done rather like printing on paper. Just as a printing works can print only a certain number of acres of paper a day — a number determined largely by the initial investment in machinery — so a silicon chip factory can process only a certain area of silicon a day — an area limited by the amount of very expensive masking, etching, baking and testing equipment it has.

The cost of a chip is mainly proportional to its area, and has very little to do with how complicated it is. In other words, it is just as expensive to produce a 6in. diameter of wafer of silicon carrying

(continued on next page)



Checking one of the many masks, drawn several 100 times final size.

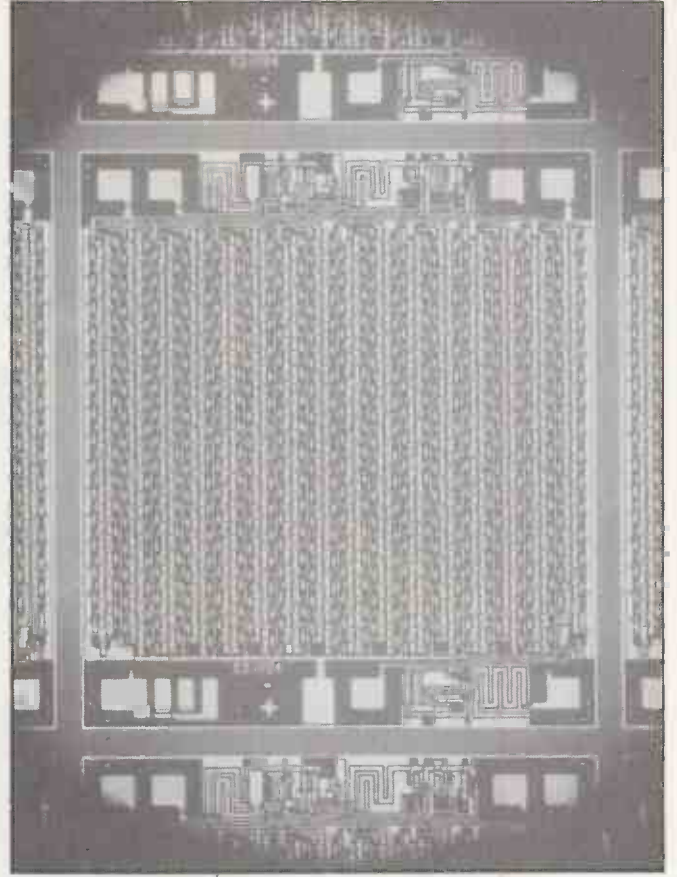

Close up of a single chip.

(continued from previous page)

a single transistor as it is to put 400 devices on it, each consisting of 100,000 transistors. U.S. chip makers talk about the area of silicon they can process as the real estate.

Now we can see why smallness is important in microelectronics. Since it does not matter to the final cost how many transistors are on a chip, the more there are, the cheaper each one is — or, you can offer more computing power at the same price.

Improved factors

Even if that were the only plus, it would be well worth going for smaller devices, but, there is more. As transistors become

smaller by a factor n so a number of things improve:

- Switching times improve by n .
- Capacitance of lines decreases by n .
- The power consumption decreases by n^2 .
- The number of devices on a chip increases by n^2 .

Generally, if you measure computing power as the product of the number of devices times the clock speed, it improves by n^3 . That means a new device with lines half as wide as an old one will be, other things being equal, eight times as powerful at the same cost.

Even more surprisingly, there is still a good deal of downhill running to go. While it is apparent that at some small size, the bulk electronic effects relied on

to make transistors work will give way to other quantum effects, it does not look as though that will happen before lines get to about $.25-.1 \mu\text{m}$ wide.

To give an idea of the density of the technology: if a map of London were engraved with $.1 \mu\text{m}$ lines on a 6in. diameter wafer it could show every house, street, alley and detail down to the scale of lamp-posts and man-hole covers.

That gives us a scaling factor of up to 60 on current technology, so we can expect processors with roughly $40^3 = 216,000$ times of today's power. Since device densities have roughly doubled each year since 1960, we can reasonably expect the pocket computer with the processing power of a quarter of a million Z-80s by 1990. Yet, as they also say in the States, there is a downside to this interesting prospect, and that is caused by human fallibility.

Device yield

Naturally enough, the proprietor of the silicon chip factory will prefer to see as many as possible of the little chips he makes in the morning emerge as fully functional, tested, packaged and brand-named products by the evening.

Any chips which fail to make the grade are so much wasted real estate and increase the price of the survivors in proportion. The number of useful devices which emerge at the far end of the whole process is called the yield.

A yield of 30 percent is considered

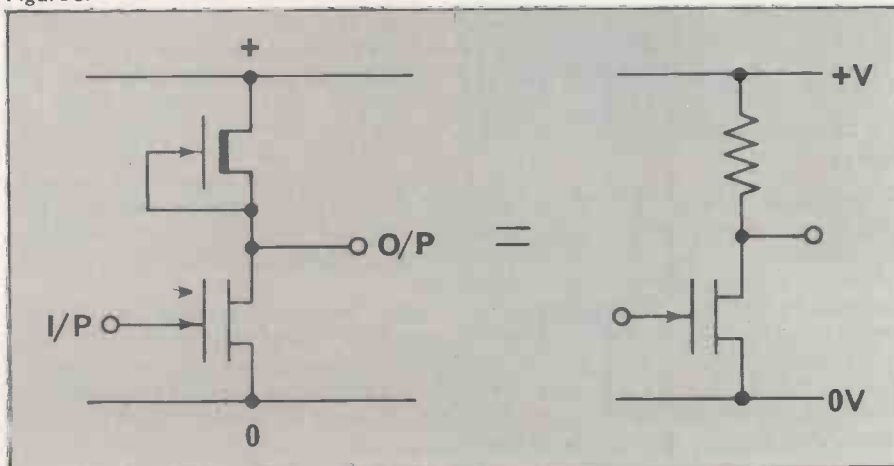

good. In other words, of the 400 or so chips made on a single wafer, some 280 are thrown away. The rest meet the standards and are sent on to consumers. Today's processors and memories are so complicated that it is not practical to test more than a few of their possible functions and states. In fact, to test every possible state a Z-80 processor chip could enter would take longer than the life of the universe. More complicated chips will be even less testable.

Fatal flaws

Now, if the effect of scaling on computing power seemed uncharacteristically benign of Mother Nature, we begin to see why. She has a much better joke up her sleeve. A rough sum about yield suggests that if N is the number of fatal flaws per unit area of chip, and A is the area of each chip, the yield of good chips is given by the Poisson distribution:

$$Y = e^{-NA}$$

What causes fatal flaws? Dust, imperfections in the underlying silicon, errors in the masks, lack of registration of one mask with another, caused by the differential contraction of silicon and the subsequent layers. Also, from time to time, someone drops a complete wafer.

If one makes the reasonable assumption that, using the same fabrication technology, the probability of misalignments, dust particles, flaws in the silicon being enough to kill a chip is inversely proportional to the square of the line width, halving the line width reduces the yield from 30 percent to one percent. If errors in the third dimension are equally fatal, the probability of obtaining a good chip goes down to one in 15,000, or .006 percent.

Scale of problem

Of course, the fabrication technology is not the same, but that may give some idea of the scale of the problem. It may explain why, for instance, instead of obtaining 100 or so good chips per wafer, Zilog was, for a while, reportedly

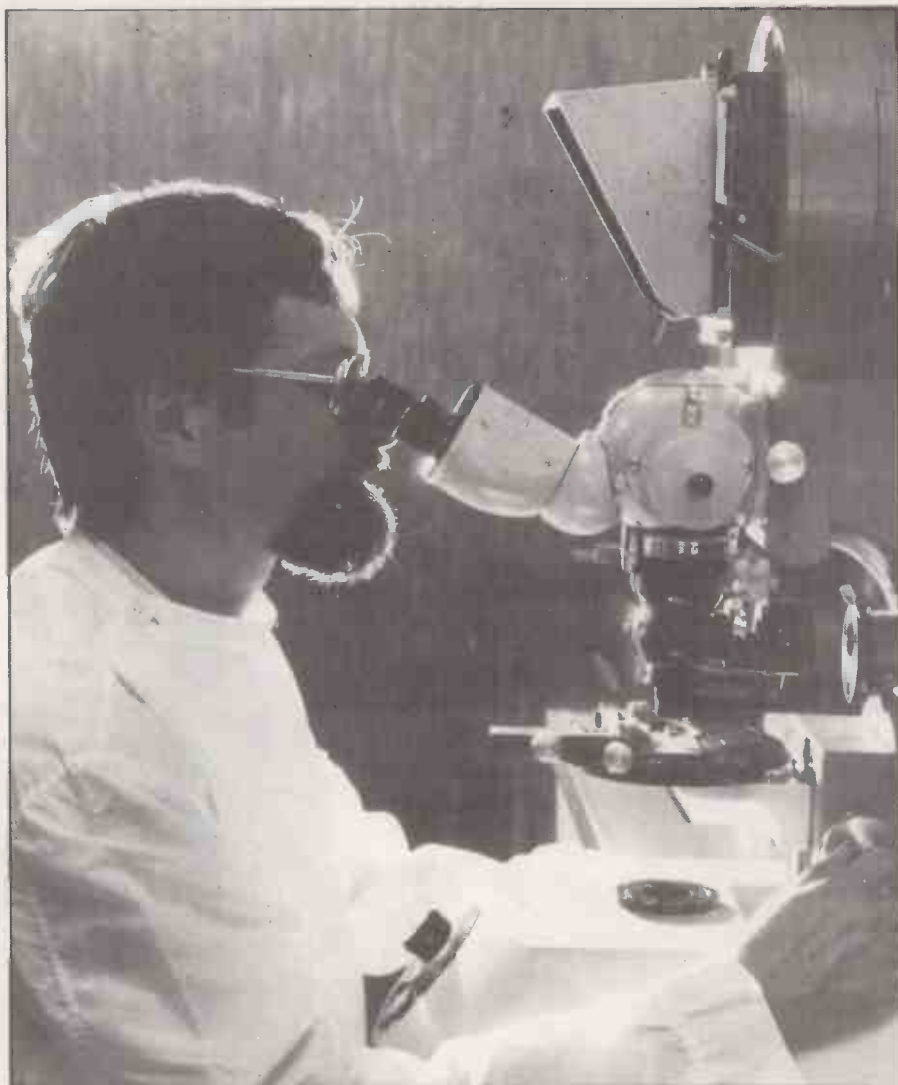

Examining the reasons for failure.

processing many wafers to gain one good Z-8000.

It may explain why, although the Z-8000 should in theory, cost the same as the Z-80, it costs some 30 times more. It may explain why, although the 64K RAM was announced with tremendous fanfare nearly two years ago, very few have ever seen one, and even fewer use one every day.

That simple analysis demonstrates the

chip-maker's problems. While the value of his products increases with the cube of the smallness, their yield, and hence what he must charge for each one, is subject to a much fiercer law. There is a long step from a prototype wonder device, made with agonising care in the laboratory to a production line making thousands a day despite hangovers, laziness and bad temper among the work-force.

Layer patterns

At the moment, chips are made using a photo-lithographic process. The patterns for each layer of the chip are drawn few of hundred times full-scale and repeated 400 times for each wafer. Light is then projected through the finished masks on to photo-sensitive resists on the wafers: the exposed resist is washed off and the underlying material etched with acid.

As line widths become smaller, problems arise. The first problem is the registration of one mask with the pattern formed by earlier masks. If the whole chip is printed as one, the problem of differential expansion and contraction as poly is

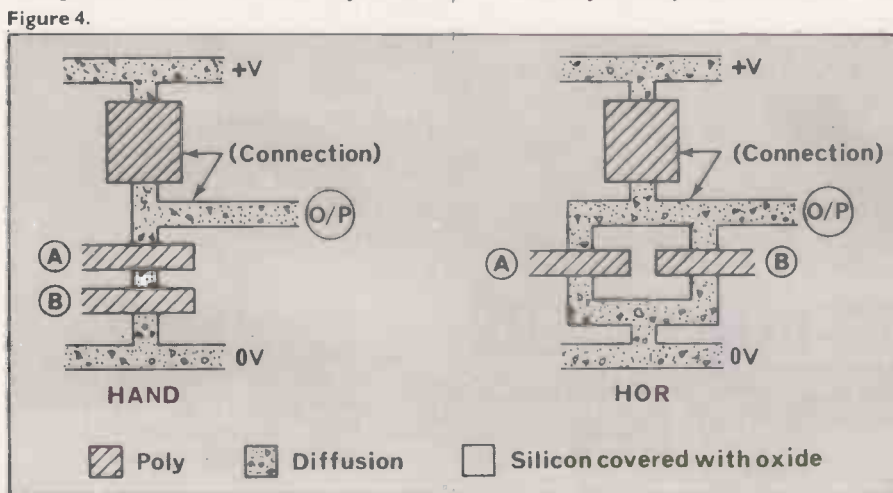

(continued on page 73)

Buying Computers?

Commodore PET 32K
£675.75 plus VAT

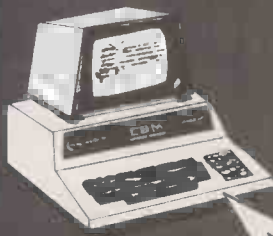

Sharp MZ-80K
£480.00 plus VAT



ITT 20/20 16K
£607.00 plus VAT



ACT 808 inc dual
disk drive
£3950.00 plus VAT



ACT 808 inc dual
disk drive
£3950.00
plus VAT

We'll give you more than a good deal

Under one roof in London's West End you can find:

HARDWARE:

A comprehensive range of hardware to meet most applications - and budgets, with terms to suit you.

SOFTWARE:

Probably the widest range of off-the-shelf software in the UK. Try out the packages and choose the one that suits you, or take advantage of our consultancy services and we will analyse, recommend, demonstrate, modify and install the programs for you.

CONSULTANCY SERVICES:

To apply micro computer systems to business, education or the home, make an appointment with our trained professionals for friendly advice based on extensive experience of discussing problems with many others like you.

MAINTENANCE AND REPAIR CLUB:

A maintenance and repair club that guarantees microcomputer users minimum downtime at very attractive premiums.

REFERENCE MATERIAL:

A library of publications covering all aspects of the microcomputer world,

including back issues of this and other important periodicals.

Whether you are an experienced micro user or a novice, looking for a system for the home, business or pleasure, the **LION MICROCOMPUTER CENTRE** is the single source to meet all your requirements.

CALL IN ANY TIME. We are open six days a week, for you to take advantage of the good deal you get when you buy from **LION**.

The above prices do not apply to account sales.



LION MICRO-COMPUTERS

SMALL COMPUTERS - TO MAKE YOUR BUSINESS BIGGER
Lion Computer Shops Ltd, Lion House, 227 Tottenham Court Road,
London W1 (First Floor). Telephone: 01-637 1601.
Telex: 28394 Lion G.
Open 9 to 6, Monday to Saturday (Thursday to 7).



• Circle No. 160

(continued from page 71)

laid down or silicon etched away can throw the outermost masks out of register even though those in the centre are perfect.

The solution is to print only in the centre of each wafer, or to use a single mask repetitively for each chip on the wafer and register it in each of 400 positions. Either solution drastically reduces yield and throughput.

The next problem is that as line widths grow smaller, they become an appreciably small multiple of the wave-lengths of the light used to print them and, in consequence, become fuzzy at the edges. The practical line width limit using visible light is $.5 \mu\text{m}$. Below that, it is necessary to use either X-rays — the synchrotron radiation from an electron storage ring such as the Rutherford Laboratory is building at Daresbury — or an electron beam.

Gold masks

X-ray lithography is much like the visible light process, except that masks have to be made from gold or platinum. Electron-beam lithography is amenable to direct control — instead of printing the beam through a mask, it can be steered by a computer, so that the various layers of a chip are written on to the silicon just as graphics on to a piece of paper. Moreover, the computer can sense the existing pattern and distort the next layer to fit. The difficulty is in drawing such complicated shapes quickly enough using feasible data rates.

One of the arguments in favour of Immos is that — unlike its U.S. competitors — it is unencumbered with expensive but outdated — by at least two years — masking equipment. It is going in for electron-beam lithography. Those who wish it well will hope that the complicated sums about yield and speed

The successful chips are divided up and packaged.

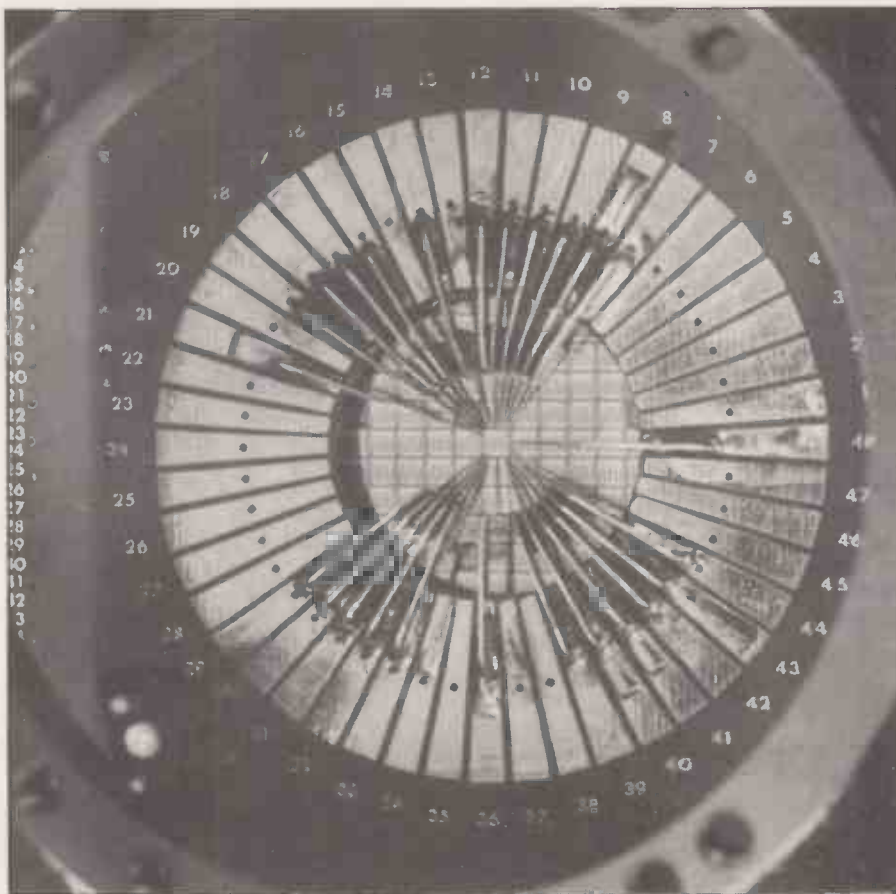
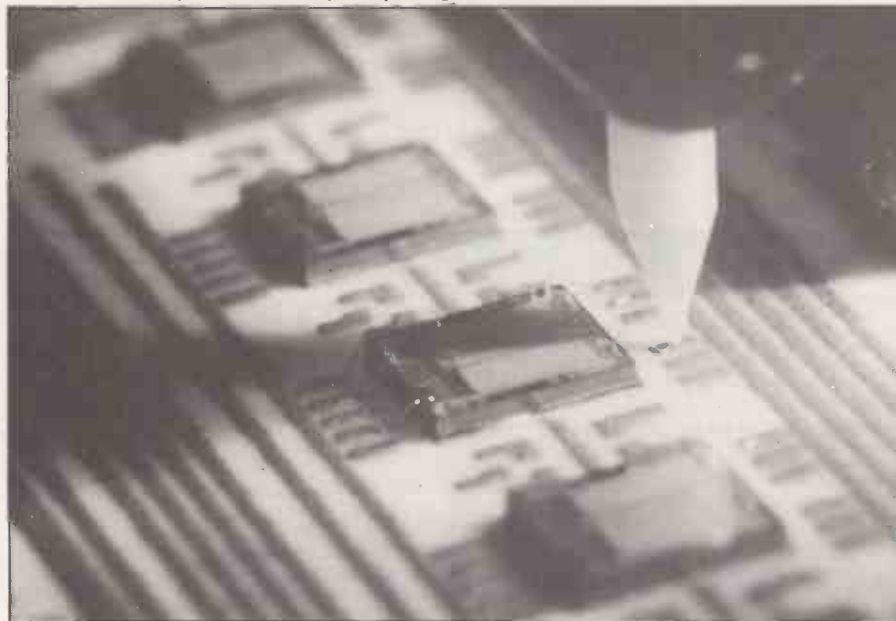

Testing each chip in turn.

of processing will prove to be correct.

An incidental advantage of equipping oneself with electron-beam equipment is that it can be used either to write directly on to the chip, or to make masks for optical or X-ray lithography.

The upshot of the whole argument is that the $.1 \mu\text{m}$ line-width goal, at which physics of conventional electronic devices starts to go wrong, is well within the current conceptual horizon. The pot of gold is definitely there; but it is not quite

so clear at the moment which rainbow to slide down to find it, and how expensive the final product will be once it is achieved.

Although the MOS transistor is so simple and relatively easy to make, it may not be what is inside the wonder machine of 1990. There are two obvious rivals on the scene. Although neither of them has been used to make a computer yet, neither has either had the benefit of the frantic development devoted to MOS technology. The first uses the Josephson Junction as its switching device.

The Josephson junction — named after the young Ph.D. student at Cambridge who discovered the effect in the 1960s — relies on the well-known quantum effect of tunnelling. While electrons in bulk are stopped dead by insulators, at very small scales there is a finite probability that an electron in a conductor will jump through a very thin insulator and appear on the other side. That is a consequence of its nature.

Probability clouds

Although one tends to think of electrons as small billiard balls, they are small clouds of probability. Most of the time the electron will be where you think it is — at the centre of the cloud, but there is a definite probability that it will be found somewhere else. Naturally, the further away one looks from the centre, the less

(continued on next page)

(continued from previous page)

likely the electron is to be found there.

Josephson junctions work at super-conducting temperatures. Electrons in a conductor fly round and round, unhampered by ohmic resistance. If they are hindered by a sufficiently thin insulator, they also fly straight through it. The insulator has to be very thin indeed. At $.005 \mu\text{m}$, it is one of the smallest things anyone has ever proposed to make on a production line.

Now, the point of the trick is that a small magnetic field will stop the electrons tunnelling through the thin insulator. The field can be just the magnetic field which surrounds any conductor carrying a current of electricity. To switch the insulator on and off, we must put a modest current through a conductor near it, resulting in an electronically-controlled switch — the basic computing element.

The real reward is that switching takes place in pico seconds — 10^{-12} secs — some 3,000 times faster than today's MOS and still much faster than the $.1 \mu\text{m}$ MOS projected for 1990. Moreover, because Josephson circuits use so little power — being mainly in the super-conducting state — the designers of a computer using them can afford to terminate the lines properly with resistances to prevent reflections.

Execution time

That means that such a machine is not restrained by instabilities on the lines and can operate with a clock running at 100 MHz — i.e., an instruction execution time of $10 \mu\text{s}$. However, in that time light moves only 300cm. To prevent the different parts of the computer becoming out of step with each other, the whole device cannot be more than 30cm. long, wide or high.

The disadvantage to Josephson technology is that the circuits seem somewhat more complicated than MOS versions, and may, therefore, be less economical in the all-important real estate. Also, such a machine must be kept in liquid helium, and even though the liquidiser may be no bigger than a domestic fridge, it adds an extra complication.

The problem with conventional com-

The final product in the chip-making process.



Figure 5. Lay-out for a binary processor tree.

puting is that it uses electrons as abacus beads. Small and light though electrons are, it takes appreciable amounts of power to hurl them about as fast as a computer designers would like.

The solution may be to turn to smaller and lighter beads — photons, the weightless, though not momentum-less, particles of light itself. There is a means of generating light in the semiconductor laser, and a way of making one beam switch another in the transphaser being developed at Heriot Watt University in Edinburgh, but at the moment only single switches have been made and the devices measure millimetres rather than micrometres.

Though it seems that conventional electronics will work at line widths of about $.1 \mu\text{m}$, beyond that the puzzles start. Bulk effects like resistance cease to apply. Electronics must be considered as wavelike rather than billiard balls, and a whole host of new problems arise, of which not the least is the electron's probabilistic nature.

When circuits become really small, for a good deal of the time, the electron you thought was in one conductor will be in its next-door-conductor, or over on the other side of the chip which makes for confused computing. A great deal of work is being done, mainly in the U.S., of course — but also in the U.K. by Dr John Barker and his team at Warwick University — but no one expects real results for 10 years.

Whatever the technology of the

switches in the computer of the 1990s, it will still be a main consideration of the designers to speed it by reducing the lengths of conductor between the active devices. One promising way to do that seems to be to re-design the architecture of the whole machine.

We are used to serial computers in which a single processor moves very quickly through a long queue of instructions and data. Although that works, it is clear that it is not how nature computes. It is also clear that it forces the designer to employ very long line lengths — how far is it in nanometres, from your CPU to the average RAM cell? For both of those reasons, people are considering very hard parallel-processing systems in which a hierarchy of processors, each with its own morsel of memory attacks a problem at many levels at once — figure 5. See Carver Mead and Lynn Conway, *Introduction to VLSI Systems*, Wesley Addison, 1979.

Four levels

One scheme is to have four levels on a chip. Each processor controls two in the level beneath; the processors at the fourth level have access to a piece of RAM each. Such a machine can act as a conventional single processor single block of RAM combination by making the intermediate level processors repeat their inputs. Or it can function as 16 parallel processors by making the higher-level processors transparent, or in any configuration in between.

That encapsulates the present state of play. Hardware is rapidly ceasing to be a problem. Soon, we will have vast amounts of processing power and memory. What we do not yet have is the software to begin to take advantage of it. It has been justly said that if hardware development stopped today it would take 10 years for software to take full advantage of everything the 8-bit processors can do. Hardware will not stop today, or any day for at least the next two decades.

So the software business is going to have unlimited scope for ingenuity and development. If we think there is a programmer bottleneck now, it will be insignificant beside what is to come. The future is exceptionally challenging and intriguing. □

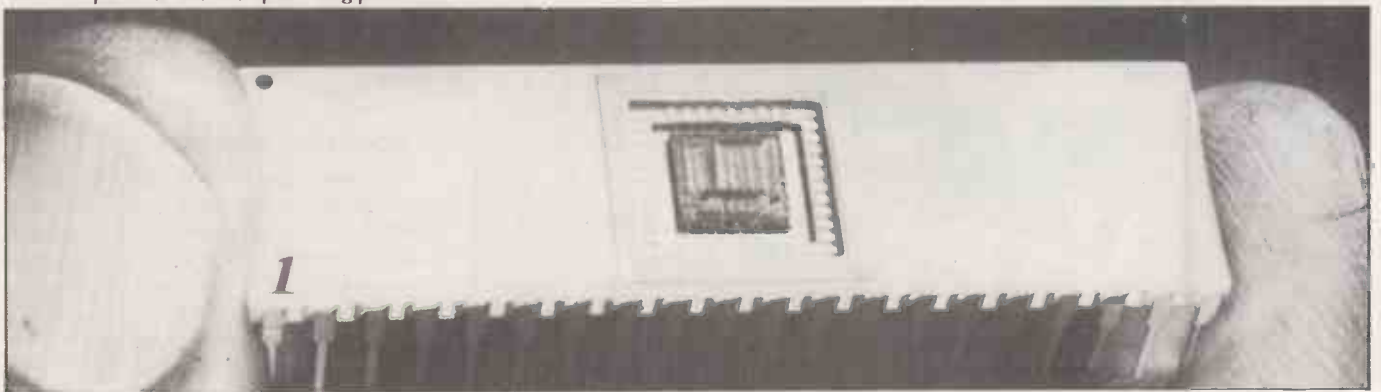

INTEGRATED SMALL BUSINESS SOFTWARE

ISBS

ISBS - F

A totally Integrated Small Business System designed for single user floppy disk based systems. ISBS-F is already being used by many Businesses and Professions throughout the UK. Each package can be used as standalone or can be built into an integrated system depending on user requirements. All packages are fully supported and maintained, and are supplied with easy to follow Reference Manuals. ISBS-F is easy to install and ideal for the first time small Business user with no previous computer experience.

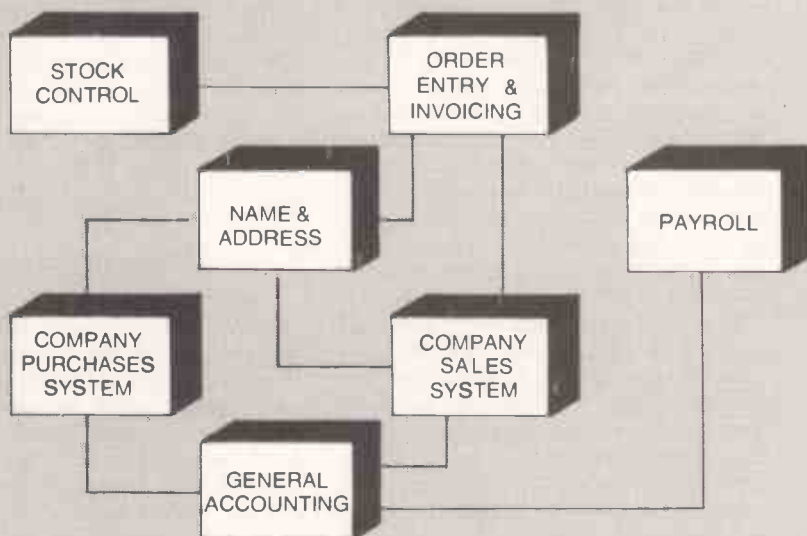

ISBS - W

A Hard disk or Winchester disk based Integrated Business Software system which is upwards compatible with ISBS-F. This system is ideal for the small to medium size user where data storage and processing speed exceeds the capabilities of floppy disk based systems. Choose from any combination of modules and add others at a later stage if required. The system features many facilities found in minicomputer and mainframe business packages. All modules are fully supported and maintained and comprehensive documentation is supplied with each installation.

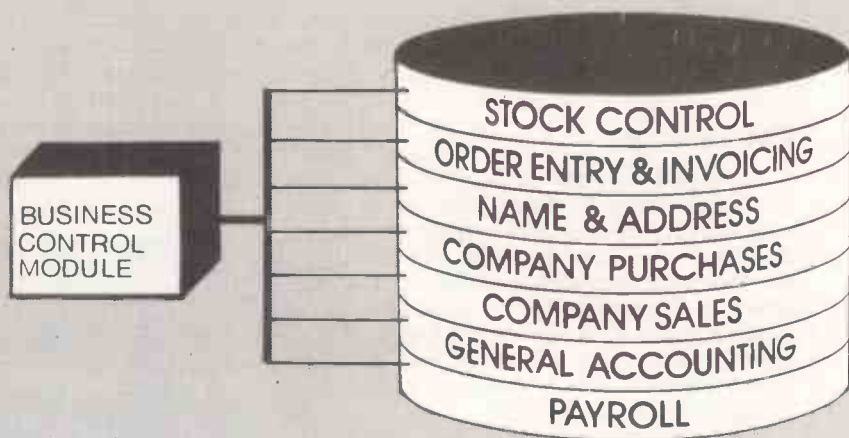

SYSTEM REQUIREMENTS

ISBS has been designed for most popular 8080/280 Microcomputer disk systems running under CP/M*

ISBS-F: 48k & 2 floppy disk system, VDU, 132 col printer, CP/M* 1.4 or 2.x

ISBS-W: 64k & Hard disk(s) system, VDU, 132 col printer CP/M* 2.x or MP/M*

Current installations on Rair Black Box, Northstar, Heath, Cromemco, Altos, Superbrain, IMS 5000/8000, Dynabyte, Micromation.

For further details and prices contact your nearest dealer or call us direct.

*CP/M, MP/M trademarks Digital Research.

GRAFFCOM
SYSTEMS GROUP

52 Shaftesbury Avenue London W1 01-734 8862

Sharper competitive edge for computerised estate agency

Martin Hayman met Colin Yarwood and Chris Murphy, one an accomplished estate agent, the other a computer professional, and discovered how they developed the successful estate agents' package, Microbase.

COLIN YARWOOD was already a successful estate agent in the Oxfordshire partnership, Buckell and Ballard, when he discovered the micro. He had risen with some alacrity to become a branch partner in the pleasant, thriving country town of Wallingford. In his mid-thirties, he found himself with a capable staff whom he had more or less trained to take over his own job of selling houses; the prospect of an increasingly sleek and torpid lifestyle presented itself. Then the micro arrived.

Less than three years later, much has changed about Yarwood's life. He has a new business as an Apple dealer and consultant, has a partner in the enterprise who is busy negotiating with Government agencies for new software contracts; and within his own business of estate agency he finds himself courted by famous estate agents, such as Bristol's Bruton, Knowles, who arrived from all over the country to see how his wonderful computer-assisted system works.

Change and expansion in all around he sees; where a few years ago, the reward of unswerving devotion for the rest of his natural would perhaps have been the chairmanship of the company as he approached retirement age.

Two worlds

On the face of it, there could scarcely be two more different businesses than houses and microcomputers. The former is traditional, the latter seems at times to have not only no tradition, but no rules either. In estate agency, nothing is done by coercion, all by the gentleman's agreement — estate agents are not allowed to form themselves into limited companies but must remain partnerships.

When the subject is micros, any innovation is worth examination, and maybe serious consideration; in houses, people have the most rigorously conservative idea of what they want. If what they want is a suitable heated cupboard for the dog and a porthole-style window next to a Purbeck-stone chimney, they are prepared to stand doggedly by that ideal. That kind of conservatism seems to be reflected by the estate agents.

The initial impetus for a computer system at Buckell and Ballard's, the Wallingford branch, was from the accounts department, which was having difficulty coping. At first, Colin Yarwood scanned the professional journals for whatever the major manufacturers of

office equipment would produce. The results were a nasty, expensive surprise: "We were given a quote of about £60,000 split 50/50 between hardware and software. Now there is no way that kind of expense is going to be acceptable to a company like ours, which is a partnership".

Further investigation

Yarwood investigated further and decided a computer might not only relieve pressure on the accounts department — but also tackle some rather cleverer stuff which would match the requirements of an applicant — someone who has arrived at the estate agent with a request to be supplied with details of houses and its reverse: finding suitable applicants from their lists to whom to send details of newly-listed properties.

In the latter case, it is a considerable advantage to be able to supply those details to the applicant before another agent does. That way you are more likely to make the sale and collect the percentage. From that point of view, a system which would print-out details after sorting suitable applicants, and then address the labels, was the ideal towards which Yarwood — and I daresay, estate agents over the years — have been striving.

After six months, Yarwood had looked Chris Murphy and Colin Yarwood.

at IBM, Hewlett-Packard, Sperry Univac, ICL and other business equipment manufacturers. Then, the whisper single-board computer reached him from one of his Round Table acquaintances, who ironically enough dealt in radio and TV. He pointed Yarwood in the direction of ITT, which in its turn, suggested he contact the ITT dealer for the area, Microsense. At Microsense, he was introduced to Chris Murphy, a computer professional who had worked for Burroughs and was now doing software development.

Yarwood detailed his requirements to Murphy and together they worked on a draft version of the estate agents' package, which was to become Microbase. The development was done on an ITT 2020 but for commercial use it went straight on to an Apple 2 with no modifications — and with no problems either.

Thermal printer

Out went the old Elliot Addressed cut-card system with its noise and its heavy, expensive, cut cards; in its stead was the Apple with a thermal printer for quietness. Within a quarter of an hour of his return to the office, a negotiator would have entered the details of a house for whose sale Buckell and Ballard had just received the agency and the Apple would have matched the house to applicants and



the printer would be producing the address labels of those applicants along with the necessary number of sets of particulars.

Even allowing for the vagaries of the postal system, it was a real lead time over the opposition in the case of non-exclusive agency. To obviate waste of effort and money, a routine was incorporated to send a reminder card to each applicant after a certain lapse of time which, if not returned, meant the mailshots would be discontinued.

Soon there were interested parties queuing to see the Cyderpress system at work. Colin Yarwood enjoyed playing a game with the people who arrived to look at the system during the winter of 1979: he asked them how much they thought it cost. The answers ranged from £5,000 all-in, to £10,000 a year. The first, lowest answer is about right, and includes the residential software package and the necessary two or three days' training at Cyderpress in Wallingford.

By February, three such systems had been sold and it was rapidly becoming apparent that there was real money to be made. Up until this point, Yarwood and Chris Murphy, whom he had persuaded to join Cyderpress from Microsense, had set-up the software and training but left supply and installation to an Apple dealer in the neighbourhood. Why should they not actually supply as well as install the machines, hence the dealer's margin too? So they did.

On the whole, Yarwood was against marketing the system aggressively, figuring that word-of-mouth recommendation would bring the customers, unsolicited, to him. He was especially wary of what he refers to as the photocopier salesman syndrome and which, he feels, characterises the efforts of the software houses whose writers are first and foremost programmers and who do not bother to discover the customer's business needs.

The results, he thinks, are programs which may in themselves work well enough, but do not present what he refers to as a logical enhancement of what the customer is already doing. Obviously, with a decade of partnership behind him, and with a program developed by an Apple specialist to run on an Apple, Yarwood can permit himself such aspersions. He admits that he did try a canvas letter to 60 estate agents and — as he had expected — failed to elicit a reply from a single one.

In the meantime, Chris Murphy had been progressing with improving and updating the Microbase package to bring it up to date. The new version of Microbase is different enough for Cyderpress to call it exclusively its own, though the original package, developed by Chris while he was still at Microsense, belongs to them; and, in theory, Cyderpress would also pay royalties to Microsense on the new Microbase if it were sufficiently

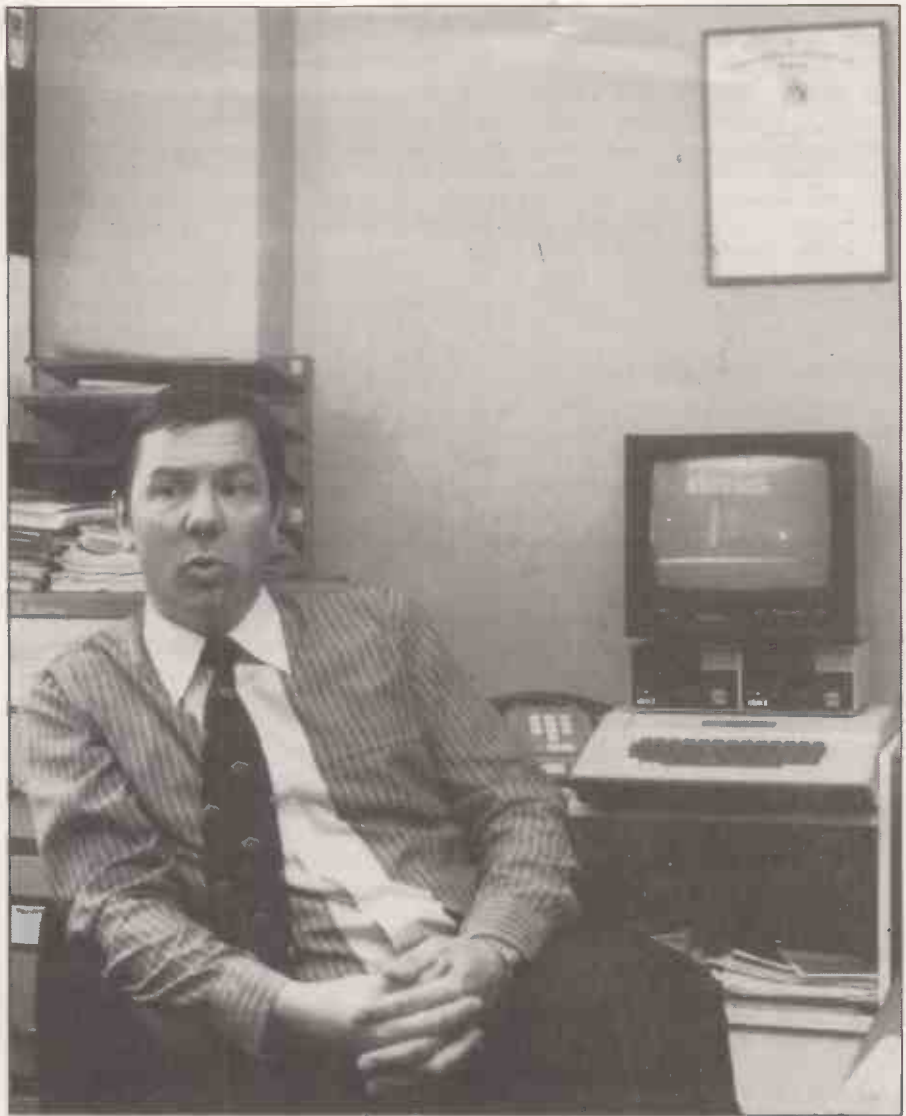

Colin Yarwood of Cyderpress.

similar to be regarded as the same program.

Fortunately, this gentlemanly agreement seems to work on a "you scratch my back, I'll scratch yours" basis; Cyderpress is still selling plenty of systems for Microsense, which in turn refers any enquiries from estate agents to Cyderpress. Obviously, with only two staff, fully occupied at that, Cyderpress is not able to undertake installations outside the Thames Valley and South Midlands area. So, it is in the process of appointing agents for its software packages; enviably, because of Murphy's connection with Microsense, it is in a good position to know which Apple dealers are suitable.

Dealer's profit

Of course, it means that it will be losing the dealer's profit on installation; on the other hand, Chris Murphy did not want to become involved in establishing a nationwide support network and in any case, the countrywide availability of the software should help to reduce its price. Murphy is, in any case, development manager and seems to be able to spend

most of his time on programming in the tiny lair down an alley which Cyderpress has taken over from a home knits shop.

One of the aspects which needs attention, and which relates to what Colin Yarwood said on business practice, is that estate agents do not operate in precisely the same way throughout the U.K. The system, as conceived by Colin Yarwood and Chris Murphy and implemented in the first place for Buckell and Ballard, is for a mixed multi-branch estate agency with town and country properties.

A London estate agent would require different systems software: he would have a great many more properties in a much smaller area being chased by fewer applicants, which means that far more storage is needed for properties — typically three properties' disc to one applicants' disc — and much more work for the printer. In Scotland and the north of England, things are different again, where exclusive agencies are the rule, and the seller is charged recoverable costs whether or not the agent sells his house.

As a result, the seller takes far more care about his choice of agent, and the

(continued on next page)

(continued from previous page)

agent in turn must be able to bill recoverable costs independently. Those are the kind of wrinkles which Cyderpress builds into each program supplied and which, claims Colin Yarwood, give Cyderpress a competitive edge over systems which are not, shall we say, synergistic? Those, in any case, which do not spring directly from an understanding of the work the machine is likely to be required to do.

Related disciplines

Nevertheless, Cyderpress is chancing its arm with packages written for other but related disciplines. Yarwood is pleased with the most recent development, an auction and saleroom system which allows the user to enter details from the registration of lots through to printing the vendor's accounts at the end of the sale. There are packages for commercial letting and renting, for accountants and for publishers.

The company had a stroke of luck, too, when it acquired — free — several extremely detailed modelling and analysis programs, written for quantity surveying jobs for the Pet, and which Murphy was able to convert without too much difficulty.

Now Murphy's sights are rising further, with the promise of another staff member to relieve him of some of the installation

and maintenance work, and he has been angling — along with, let it be said, just about every other software house in the country — for work at various Government institutions nearby — Oxford is well supplied with them — such as the Institute of Hydrology.

That is not to say that he does not find time to maintain the existing Cyderpress programs. He confesses to being unable to leave a program alone and is always looking for new ways to trap errors and reduce the length of programs. He says that this is self-indulgent perfectionism to some extent, since many of the customers who have already taken Microbase cannot even be bothered to send in their disc for an improvement to the disc controller — that kind of modification would cost typically between £20 and £60 and would take 24 hours to turn round.

The wide range of applications possibilities keeps Murphy rooting for the Apple; another is its ability to support Pascal, with the implications of upward compatibility with for example the Alpha Micro. He feels that for the purposes of Microbase and associated programs, Pascal is the best solution because it is structured in a modular fashion so that particular routines can be stored as blocks and called at will when needed, just with the parameters re-defined.

That also allows more compaction on any given disc and so has a very real effect on the bottom line of the balance sheet.

He also thinks that Pascal is currently more portable than Basic: "Unless, of course, you are operating under CP/M which I do not think is really a very good first-user language — not sufficiently user-transparent". For his purposes, he describes the principal advantages of Pascal as: faster execution speed; better utilisation of disc store; and greater software protection.

He concedes that in system-design terms, it is slower to work with because of its highly-structured nature and the pedantry of compilers, but advantageous because some system functions are procedures which can be called in and bound together as an application. From a purely selfish point of view he approves of the Apple sharing Pascal machine code and Fortran, which make a good complementary duo for development work — editing and number-crunching.

Challenge to PDP-11

The fact that the Alpha Micro, which promises to offer as much computing power as a mini of a few years ago, will support Pascal, looms largely in Cyderpress plans. With the possibility of ½MB, plus up to 90MB storage, and three workstations plus printer, Murphy believes that that kind of machine is going to challenge the PDP-11 and send operations like Cyderpress into the relatively big time. □

PROGRAM POWER

NASCOM 1 & 2

LUNAR LANDER SUPREME (32K/G/B)—classic space-craft landing simulation. Short, medium and long-range scans show planet surface in varying detail. Continuously updated STATUS REPORT gives vertical, horizontal and relative velocity, altitude, fuel level, G factor and surface scan for suitable landing site. 8 skill selections. Brilliant graphics £13.95.

STARTREK II (32K/B/G) — enthralling, real-time version from our Invasion Earth author, using M/C code sub-routines to great effect. Special features include larger galaxy, shielded homing warheads (fired by Klingons), time slots and non stop action. £13.95

INVASION EARTH (MC/G) — fast version of the popular arcade game. 4 invader types/intelligent homing, exploding, angled, direct, multiple warhead and radio-jamming missiles. 40 skill levels. Only £9.95

CLIFF INVASION (B/G) — the aliens have landed in droves. You have one remaining laser base. Your only chance — shoot the ground from under them as they descend the cliffs towards you. Landslides created. Errors in direction and elevation of shots are costly. 3 levels of skill. Like all aliens, they breed like rabbits! £8.95

SUPER LIFE (MC/G) — the BEST! — Evolution of a biological colony with 100 by 125 cell array (2/3 or 3/4 options). Use the 21 standard patterns or set individual pixels. Rotate and reflect any pattern. Select from 10 speeds. Evolution can be halted, patterns modified and new speed set. Extensive instructions — overlay technique keeps program within 8K. SIMPLY FASCINATING! £8.95

MINI-TOOLBOX (MC) — aid to BASIC programming. Features are:— REPEAT KEY, AUTO line numbering, Decimal to HEX and HEX to Decimal conversions, RECOVER (from CLOAD error) and Multiple USR(X) routines. Resides in spare memory from OC80HEX. £7.95

WORDEASE-WORD PROCESSOR (MC)

Professionally written 4K word processor:— 14 line window on text buffer and extensive on-screen editing facilities.

Insert and delete characters, lines and paragraphs. Text manipulation-copy from one section of text to another, or read in additional material from tape to any point in the text.

FIND & REPLACE facility. Exceptional formatting capability:— commands embedded in text allow complete flexibility e.g. variable tab position, indent, line length and page length. Use of up to 10 'MACROS' permits automatic inclusion of headings, footings and other 'text repeats', and also automatic page numbering.

Output to printer — can vary character delay, inhibit line feeds and force upper case if required. Text can be saved on tape and recovered.

An extensive manual is supplied (itself prepared on Word-ease). The method of formatting is illustrated in detail with a sample text. £25.00

SUPER STARTREK (B/16K)	£9.95
Spacefighter (B/G)	£7.95
Alien Labyrinth (B/G/16K)	£7.95
Driver (B/G)	£6.95
Sheepdog Trial (B)	£5.95
Slalom (B/G)	£5.95
Biorhythm (B/G)	£4.45
Labyrinth (B/G)	£5.45

**NASCOM 1 — Cottis Blandford Cassette Interface for N2 format, reliability and fast load. £16.30 or £13.30 with program order.

All programs supplied on cassettes.
B = BASIC. MC = Machine Code.
G = Graphics.
8K RAM required unless otherwise stated.
PLEASE GIVE FULL DETAILS OF YOUR NASCOM

MUSIC BOX

Now you can make music with NASCOM. Easy to follow program allows you to key in old favourites or have fun composing your own tunes. 7 octave range with staccato option. 9 tempos. Set note duration or tap in rhythm as required. Comprehensive editing. Delete, insert or amend notes. Single-step forwards and backwards through tune. Add new lines within declared array size. The program includes tape generating and playback routines and is supplied with 2 demonstration melodies and instructions for connecting your Nascom to an amplifier/speaker such as our unit below. Min. 16K required — please state T4 or Nas sys/2 or 4 MHZ / with or without graphics. Only £13.95

MUSICAL BREAK-OUT (MC/G)

You have 8 chances to hit all the bricks out of a moving wall. The object is to keep the ball in play. As in squash, the angle of bounce is not always predictable. Good reflexes required. If fitted with an amplifier/speaker, different notes are produced on hitting the various bricks. £6.95

COWBOY SHOOT-OUT (MC/G)

Full feature Cowboy Shooting game for 2 players. Two versions played alternatively — firstly, shoot your opponent across 'Main Street' avoiding the moving Chuck Wagons and then through a wall which has to be demolished first. Complete with sound of shots and musical accompaniment when fitted to an amplifier/speaker. £6.95

AUDIO INTERFACE BOARD/ SPEAKER

Compact and ready assembled, suitable for use with "Music Box" and other 'sound effects' programs. 3 simple connections. Complete with instructions on programming for sounds. £9.75

WRITTEN ANY PROGRAMS? WE PAY HANDSOME ROYALTIES!
PROGRAM COMPETITION — 3 XTAL BASICS TO BE WON — Send sae marked "Competition" for details. (Closing Date 10th January 1981)

Please add 45p/ order P & P.
V. A. T. of 15% payable after 14/1/81.
SAE for FULL CATALOGUE to
PROGRAM POWER
5, Wensley Road, Leeds LS7 2LX.
Telephone (0532) 683186.

• Circle No. 162

PRACTICAL COMPUTING January 1981

First the Z80[®]—the generation-ahead microprocessor.



Now, Zilog introduce the generation-ahead microcomputer.

Zilog's new microcomputer system is built round the world's most sought after microprocessor – the Zilog Z80; used in 85% of all microcomputers. So who better to produce a system that gets the most out of it?

There's a vast library of applications software, covering accounting, stock control, payroll, word processing and management data, with two operating systems; Zilog's own high powered RIO and the popular CP/M, making this one of the most versatile microcomputers available anywhere.

Hardware reliability is outstanding with 8000 hours Mean Time Between Faults, and at normal use that's about 5 years. Should you need it, there's the support of Zilog's own staff plus a nationwide Zilog trained support team.

There's a full range of literature from first steps to very advanced technology.

Systems, including central processor with twin floppy disks, VDU and printer start at £3500.

Call Zilog or return the coupon and discover how far ahead the Zilog generation is.



Zilog

Welcome to tomorrow's world.

Zilog UK Ltd.,
Babbage House, King Street, Maidenhead, Berks.
Tel: 0628 36131.
Please send me full data on Zilog's new microcomputer range.

Name

Company

Address

Telephone

PC1/81
79

Why the Sinclair ZX80 is Britain's best selling

Built: £99.95

Including VAT, post and packing, free course in computing, free mains adaptor.

Kit: £79.95

Including VAT, post and packing, free course in computing.

This is the ZX80. A really powerful, full-facility computer, matching or surpassing other personal computers at several times the price. 'Personal Computer World' gave it 5 stars for 'excellent value'. Benchmark tests say it's faster than all previous personal computers.

Programmed in BASIC—the world's most popular language—the ZX80 is suitable for beginners and experts alike. And response from enthusiasts has been tremendous—over 20,000 ZX80s have been sold so far!

Powerful ROM and BASIC interpreter

The 4K BASIC ROM offers remarkable programming advantages:

- * Unique 'one-touch' key word entry: the ZX80 eliminates a great deal of tiresome typing. Key words (RUN, PRINT, LIST, etc.) have their own single-key entry.
- * Unique syntax check. A cursor identifies errors immediately.
- * Excellent string-handling capability—takes up to 26 string variables of any length. All strings can undergo all relational tests (e.g. comparison).
- * Up to 26 single dimension arrays.
- * FOR/NEXT loops nested up to 26.
- * Variable names of any length.
- * BASIC language also handles full Boolean arithmetic, conditional expressions, etc.
- * Randomise function, useful for games and secret codes, as well as more serious applications.
- * Timer under program control.
- * PEEK and POKE enable entry of machine code instructions.
- * High-resolution graphics.
- * Lines of unlimited length.

Unique RAM

The ZX80's 1K-BYTE RAM is the equivalent of up to 4K BYTES in a conventional computer—typically storing 100 lines of BASIC.

No other personal computer offers this unique combination of high capability and low price.



The ZX80 as a family learning aid. Children of 10 years and upwards are quick to understand the principles of computing—and enjoy their personal computer.

The Sinclair teach-yourself BASIC manual

If the specifications of the Sinclair ZX80 mean little to you—don't worry. They're all explained in the specially-written 128-page book (free with every ZX80). The book makes learning easy, exciting and enjoyable, and represents a complete course in BASIC programming—from first principles to complex programs.

Kit or built—it's up to you

In kit form, the ZX80 is pleasantly easy to assemble, using a fine-tipped soldering iron. And you may already have a suitable mains adaptor—600 mA at 9V DC nominal unregulated. If not, see the coupon.

Both kit and built versions come complete with all necessary leads to connect to your TV (colour or black and white) and cassette recorder. Plug in and you're ready to go. (Built versions come with mains adaptor.)

personal computer.

Now available for the ZX80... New 16K-BYTE RAM pack



Massive add-on memory. Only £49.95.

The new 16K-BYTE RAM pack is a complete module designed to provide you – and your Sinclair ZX80 – with massive add-on memory. You can use it for those really long and complex programs – or as a personal database. (Yet it can cost as little as half the price of competitive add-on memory for other computers.)

For example, you could write an interactive or 'conversational' program to show people what your ZX80 can do. With 16K-BYTES of RAM, they could be talking to your computer for hours!

Or you can store a mass of data – perhaps in a fairly simple program – such as a name and address list, or a telephone directory.

And by linking a number of separate programs together into one giant, but modular, program, you can achieve the same effect as loading several programs at once.

We're also confident that it won't be long before you can buy cassette-based software using the full 16K-BYTE RAM. So keep an eye on the personal computer magazines – and brush up your chess perhaps!

The RAM pack simply plugs into the existing expansion port on the rear of the ZX80. No wires, no soldering. It's a matter of seconds and you don't need another power supply. You can only add one RAM pack to your ZX80 – but with 16K-BYTES who could want more!

How to order

Demand for the ZX80 exceeds all other personal computers put together! So use the coupon to order today for the earliest possible delivery. All orders will be despatched in strict rotation. We'll acknowledge each order by return, and tell you exactly when your ZX80 will be delivered. If you choose not to wait, you can cancel your order immediately, and your money will be refunded at once. Again, of course, you may return your ZX80 as received within 14 days for a full refund. We want you to be satisfied beyond all doubt – and we have no doubt that you will be.

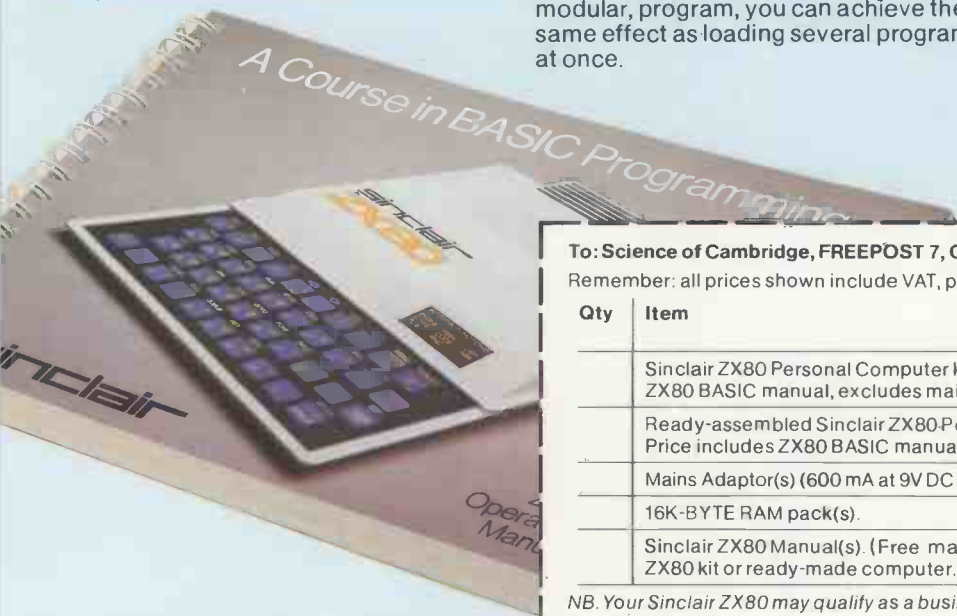

To: Science of Cambridge, FREEPOST 7, Cambridge CB2 1YY.

Remember: all prices shown include VAT, postage and packing. No hidden extras. Please send me:

Qty	Item	Code	Item price £	Total £
	Sinclair ZX80 Personal Computer kit(s). Price includes ZX80 BASIC manual, excludes mains adaptor.	02	79.95	
	Ready-assembled Sinclair ZX80 Personal Computer(s). Price includes ZX80 BASIC manual and mains adaptor.	01	99.95	
	Mains Adaptor(s) (600 mA at 9V DC nominal unregulated).	03	8.95	
	16K-BYTE RAM pack(s).	18	49.95	
	Sinclair ZX80 Manual(s). (Free manual with every ZX80 kit or ready-made computer.)	06	5.00	

NB. Your Sinclair ZX80 may qualify as a business expense.

TOTAL: £

I enclose a cheque/postal order payable to Science of Cambridge Ltd for £ _____

Please print

Name: Mr/Mrs/Miss _____

Address _____

FREEPOST – no stamp needed.

81

PCI/81

sinclair ZX80

Science of Cambridge Ltd.

6 Kings Parade, Cambridge, Cambs.,
CB2 1SN. Tel: 0223 311488.

SUPERBRAIN™

FROM **SUN** THE GROUP WITH A WEALTH OF HARDWARE & SOFTWARE EXPERIENCE IN THE COMPUTER INDUSTRY.

NOW WITH HARD DISK



NOW PLUG IN UP TO 116 MBYTE WINCHESTER DISK TO YOUR SUPERBRAIN

PRICES START FROM £2995.00 FOR 14.5 MBYTE AND ALLOWS CONNECTION OF 8 INCH FLOPPIES, CARTRIDGE BACK UP AND CAN BE SHARED BY UP TO 4 SUPERBRAINS
PARALLEL PORT & REAL TIME CLOCK ALSO AVAILABLE

FOR FURTHER INFORMATION CONTACT YOUR NEAREST DEALER

BEL COMPUTER SYSTEMS LTD, Wilnecote Lane, TAMWORTH, Staffordshire, B77 2LE. (0827) 50604. Mr Bob Sutherland.
BOWBRIG MICRO BUSINESS SYSTEMS, Bowbrig Whauphill, Newton, STEWART. DG8 9PY. (098 884) 289. Mr E.L. Tommey.
CAMBRIDGE MICRO COMPUTERS LTD, Cambridge Science Park, Milton Rd., CAMBRIDGE. (0223) 314666. Mr M.H. Jacobs.
COVERHILLS LTD, 1 Greenwich Drive, Lytham St. ANNES, Lancs. 0253 737459/738688. Mr F. Watson.
COMPUTER SALES & SOFTWARE CENTRE LTD, 180-182 Cranbrook Rd., ILFORD, Essex. 01-554 3344. Mr K. Neal.
DATASTREAM (JERSEY) LTD., 2 Belmont Road, St Helier, JERSEY. 0534-77404. Mr A.I. Vidamour.
DEACON HOARE & CO LTD., 27 Regent St, CLIFTON, Bristol BS8 4HR. (0272) 312374. Mr P.M. Garner.
GEMSOFT COMPUTER SERVICES, 27 Chobham Rd, WOKING, Surrey GU21 JJD. (04382) 22881. Mr N. Tyler.
HARTLEY COMPUTING, 16 Park Rd., COVENTRY, CV1 2LD. (0203) 27851. Mr S. Hartley.
JAGOR TECHNICAL SYSTEMS LTD., 81 Atherley Rd., SOUTHAMPTON, SO1 5DT. (0703) 20579. Mr J.G. Cruickshank.
KARADAWN LTD., 2 Forrest Way, Gatewarth Industrial Estate, Great Sankey, WARRINGTON. (0925) 572688. Mr S. Costello.
MERCATOR MANAGEMENT CONSULTANTS LTD., 6 Wyvan Terrace, CLIFTON, Bristol. 0158 4HR. (0272) 33636. Mr P. Willis.
MICRO AUTOMATION COMPUTING LTD, 207 Putney Bridge Rd., Putney, LONDON SW15 2NY. 01-874 2535. Mr D. Shorter.
PENNY COMPUTER SYSTEMS, 15 MAIN AVENUE, Peterston-Super-Ely, SOUTH GLAMORGAN, CF5 6LQ. (0446) 760681. Mr John Penny.
ROGER SALISBURY SMITH, COMMERCIAL SERVICES, Moonrakers, Wheatheat Enclosure, LIPHOOK, Hants, GU30 7EJ. (0428) 722563.
STATUS APPOINTMENTS, 11 Midland Personnel Services Ltd, 103 Kingsway, SWANSEA, WEST GLAMORGAN. (0792) 26016. Mr A.W.J. Dilnot.
STARWEST COMPUTER SERVICES LTD., 3 Grove Place, BEDFORD. (0524) 57135. Mr R. Gould.
SYSTEMATIKA LTD, 36 Montpellier Grove, LONDON NW5, 01-506 4585. Mr Lindsey.
TURNKEY COMPUTER TECHNOLOGY LTD., 23 Calderglen Rd., ST. LEONARDS, East Kilbride, (03562) 39466. Dr B. Wood.
QUEST COMPUTERS SYSTEMS, Lloyds Bank Chambers, 7 Park Street, SHIPNAL, SHROPSHIRE. (0952) 460214. Mr R., Carter.
ZETA DYNAMICS LTD, Riverway, NEWPORT, ISLE OF WIGHT. (0980) 527725. Miss L. Haywood.
ROCKLIFF BROTHERS LTD, Long Lane, Aintree, LIVERPOOL, L8. (051 521) 5830. Mr M. Taylor.

SUN COMPUTING SERVICES LTD
138 CHALMERS WAY, NORTH FELTHAM TRADING ESTATE
FELTHAM, MIDDX. TEL: 01-751 5044
TELEX: 8954428 SUNCOMB

DEALER ENQUIRIES WELCOME

SUPERBRAIN™ is the registered trademark of Intertec Data Systems.

Incorporating a control-key function into your programs

Jonathan Dick presents two programs — one in Basic, the other in assembler — which use the run-stop key as a control key to generate control characters.

CONTROL CHARACTERS are normally used in computers for controlling output and for communication purposes. In the Pet, some are used for controlling the position of the cursor. The normal control characters have ASCII values between zero and 31. Only a few can be generated directly from the keyboard on the Pet using the cursor control keys. One which can be generated is control-Q which, when printed between quote marks, appears as a reverse-field 'Q'. That character is used to move the cursor down one line.

The programs I have written to enable the run-stop key to be used as a control key are subroutines designed to be incorporated into your own programs. The Basic version is called with 'GOSUB 10000'. That command will replace the 'GET' command you would normally put in the program. The subroutine returns with the variable KY\$ set to the character that was entered.

The first task the subroutine performs when called is to disable the break-in function of the run-stop key; that is done with the usual POKE. If your Pet has old ROMs, you will have to change it to POKE 537, 136. At line 10010, once a key has been pressed line 10020 checks to see if it is the run-stop key which has been pressed. The run-stop key has an ASCII value of three as can be seen from the listing.

Instead of putting CHR\$(3) in the program, it would have been possible to replace it by typing a quote and hitting the run-stop key. That would have produced a reverse-field 'C' which would have done just as well for the comparison.

It would, however, not have shown as well in the listing. If you have not pressed the run-stop key for the 'GET' in line 10010, you must have typed a normal character. The break in function is restored — for old ROMs, change to POKE 537, 133 — and a return is executed.

If you have pressed the run-stop key, the program waits for another key to be pressed which is done in line 10030. That key is the control character you want to generate. The valid control characters are: 'Control: @, A-Z, [/\]←'. They produce the control codes zero to 31 respectively.

If you type any other character, the program loops back to the start and waits for you to press a key again in the loop at line 10010. If you have pressed the run-stop key again, you have cancelled the

control-shift mode and the program loops back to 10010.

When you have entered a correct Control character, 64 is subtracted from its ASCII value to make it fall in the range zero to 31. The break in function is the re-enabled as described earlier and a return is executed.

The first version of the program was written so it would be possible to have a control key in assembler programs. It follows the same method as the Basic program, except it does not disable the break-in function as that is not operative for machine-code.

The character typed is returned in location Hex B2 — for old ROMs, use any free location for this; location six would be a good one. The 'GET' subroutine

location does not have to be changed as the jump into it is in the same location in the old and new ROMs.

A full list of the names of the control characters is given on page seven of the Pet manual, second edition. An example of one of the names is the one given to control-A. It is called 'SOH', start-of-header, and is often used when terminals are communicating with a central computer. It indicates a useful function for the control-key programs.

That is when you are writing a terminal emulator program to communicate with a central mainframe computer via a modem. Several of the control characters are used in those computers for file editing and other functions making a control key on the terminal essential. □

```

0001 0000 ;*****
0002 0000 ;*
0003 0000 ;* ASSEMBLER VERSION OF 'GET' SUBROUTINE *
0004 0000 ;* USING STOP KEY AS CONTROL KEY *
0005 0000 ;* PROGRAM IS FULLY RE-LOCATABLE *
0006 0000 ;* CHARACTER RETURNED IN LOCATION $B2 *
0007 0000 ;* WRITTEN BY JONATHAN J DICK *
0008 0000 ;* COPYRIGHT (C) JJ DICK 4/9/80 *
0009 0000 ;*
0010 0000 ;*****
0011 0000 ;
0012 0000 ;
0013 0000 GET = $FFE4 ;GET A CHARACTER
0014 0000 STOP = 3 ;ASCII VALUE OF STOP KEY
0015 0000 CHAR = $B2
0016 0000 ;
0017 0000 ;*=$033A
0018 033A
0019 033A 20 E4 FF GETKY1 JSR GET ;GET A KEY
0020 033D F0 FB BEQ GETKY1 ;NO KEY PRESSED
0021 033F C9 03 CMP #STOP ;IS IT STOP?
0022 0341 F0 03 BEQ GETKY2
0023 0343 85 B2 STA CHAR ;NO, STORE CHARACTER AND
0024 0345 60 RTS ;RETURN TO CALLER
0025 0346 20 E4 FF GETKY2 JSR GET ;GET NEXT KEY
0026 0349 F0 FB BEQ GETKY2 ;NO KEY PRESSED
0027 034B C9 03 CMP #STOP ;STOP KEY?
0028 034D F0 FB BEQ GETKY1 ;YES CANCEL CONTROL SHIFT
0029 034F C9 40 CMP #10 ;GREATER THAN BOTTOM OF RANGE?
0030 0351 90 E7 BCC GETKY1
0031 0353 C9 61 OK CMP #97 ;LESS THAN TOP OF RANGE?
0032 0355 80 E3 OK2 BCS GETKY1
0033 0357 38 SEC
0034 0358 E9 40 SBC #64 ;MAKE CHAR A CONTROL CHAR
0035 035A 85 B2 STA CHAR
0036 035C 60 RTS ;RETURN TO CALLER
0037 035D
0038 035D .END

ERRORS = 0000
SYMBOL TABLE
SYMBOL VALUE
CHAR 00B2 GET FFE4 GETKY1 033A GETKY2 0346
OK 0353 OK2 0357 STOP 0003
END OF ASSEMBLY
READY.

9990 REM *** 'GET' SUBROUTINE USING 'RUN-STOP' KEY AS CONTROL KEY ***
9992 REM *** CHARACTER RETURNED IN 'KY$' ***
9994 REM *** WRITTEN BY JONATHAN J DICK ***
9996 REM *** COPYRIGHT (C) JJ DICK 6/9/80 ***
10000 POKE 144, 49
10010 GET KY$:IF KY$ = "" THEN 10010
10020 IF KY$ <> CHR$(3) THEN POKE 144, 46: RETURN
10030 GET KY$:IF KY$ = "" THEN 10030
10040 IF KY$ = CHR$(3) THEN 10010
10050 IF KY$ >=""&"ANDKY$<=""&" THEN KY$=CHR$(ASC(KY$)-64):POKE 144, 46:RETURN
10060 GOTO 10010
READY.

```

Poor-quality maths software causes irreparable damage

If bug-riddled maths packages make computers seem complicated and capricious, the damage to pupils' confidence and enthusiasm will be irrevocable — M P Thorne's indictment of currently-available software.

IT IS OFTEN said that mathematics is the obvious area in the curriculum where microcomputers could be used successfully to considerable educational advantage. If that is the case, the poor quality of the range of software available for teaching mathematics suggests that we are a long way from the successful use of microcomputers as teaching aids in other, less obvious areas of the curriculum — Latin, for instance. Much of what is currently available may be classed as poor on the basis of three criteria:

- Does the program achieve its educational objectives? Many catalogues offer software which, they claim, teaches a topic and yet which gives only practice.

As a violin teacher will tell you, practising mistakes can be harmful. Even if a given program is not helping the educational development of a pupil, the pupil may well be learning about computers which seems ideologically pure enough in these troubled economic times. That brings us to the second criterion.

- Does the program reinforce the widespread view that computers are complex and unpredictable machines, understood by and for the use of a privileged few? If it does, it is the last thing we want in our classrooms with industry and commerce poised to plunge deep into microcomputer technology, regardless of any other educational qualities it may have. In a recent Open University survey, more than one-third of the adults talked to described a particular experience in the early stages of learning to use a computer which had given them a permanent fear of computer technology.

- Is the use of the program cost-effective? If the program and computer together can cope with only one pupil at a time and the teacher has to interrupt what he is doing with the remaining 29 every few minutes to assist either computer or pupil using it, clearly not. As one of the 29 other pupils in the class, I would be very upset to see the teacher spending more time with the machine than with me. Teachers are an expensive commodity; so are computers. There seems little point in spending £1,000 on classroom computing equipment which distracts the teacher's attention from his pupils because the £15

program has errors in it or because what the pupil using it has to do is poorly explained by the program or demands unpredictable responses from him.

Most software available to teachers of mathematics from commercial sources is of the drill and practice in arithmetic variety. That is hardly surprising since it is easy, in principle at least, to program that kind of application and the list of possibilities for such treatment is substantial, including

- Fundamental operations with signed or unsigned integers
- Factorisation of integers
- Common fractions and reduction to lowest terms
- Decimals
- Percentages
- Simple algebraic manipulations
- Solving linear equations in one variable
- Ratio, proportion
- Systems of linear equations
- Graphs
- Sets

What is surprising is just how many commercial programs contain programming errors. Many teachers take time to find and correct them rather than sending them back. Thus, software houses may wait an long time before hearing of basic flaws in their goods. We know of no other product on the market for which schools would pay between £10 and £20, find the product did not work on arrival and pass it to a teacher to correct.

Figure 1.

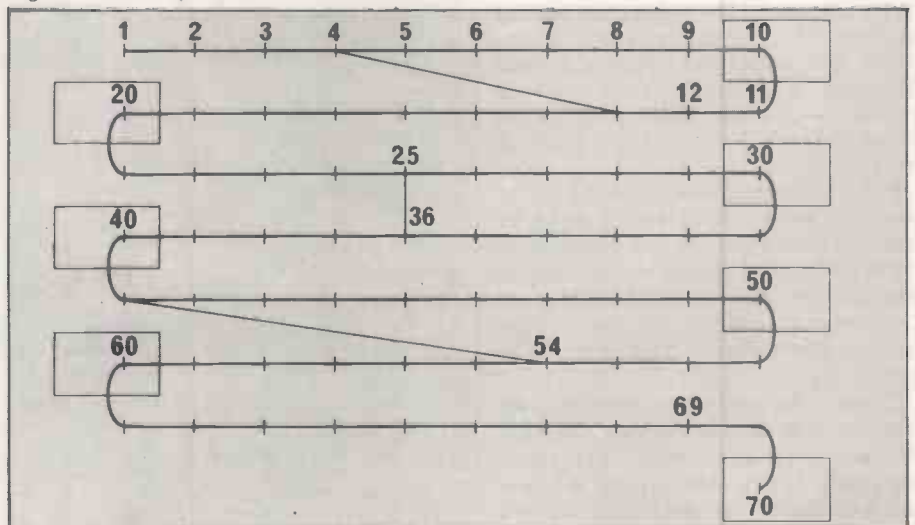

Of those free of programming errors, none even attempts to include a teaching element as you see from our brief, but representative, survey. It would be easy to program a routine which looked at a wrong answer and made helpful comments like

- "Third digit is too large"
- "I think you forgot the (a) carry"
- "Your answer is too big (small) (long?) (short?)"
- "Did you pay back the one you borrowed?"

At the moment, a pupil who obtains the wrong answer receives no help from the computer. One program simply says: "You have attained the correct answer", if you are right and: "You have not attained the correct answer", if you are wrong. Note how the programmer has gone to great lengths to talk to the children in their own language. That, too, is typical. Programmers have never been famous for their grammar: "Your now going to do 10 addition sums", and: "It doesn't matter which one", being but two endearing examples from current commercial software.

Some packages allow you to correct typing errors only at the end of the whole sum. Often you have to do the whole thing again having waited to be told that your answer was wrong — which you knew anyway.

There is little point in drill and practice if the teacher cannot keep track on how pupils are performing. Most packages display a pupil's score at the end of the session in terms of the number correct — possibly after up to three attempts — and the number wrong. It is up to the teacher to make a written record of the pupil's progress — or for the trustworthy pupil to record the score himself.

The computer keeps no record of which sums were attempted by that pupil though there is often a choice to be made of the level of difficulty of the sums presented. Here are six typical packages with some comments:

Package A: Totals delivered at the end of the session disappear after 20 seconds. Two wrong answers from 10 give 79

percent correct and 19 percent incorrect. If a sum is wrong, this cryptic response appears: "No that's wrong. The answer is six. When you have seen your mistake type any key for the next problem".

Package B: The only package of the six to insist that answers are entered as units first, then tens, then hundreds and so on. Thus, for $24+1$, you type 5 then 2. In other packages, the pupil is expected to respond to the sum

$$\begin{array}{r} 17+ \\ \underline{4} \end{array}$$

by typing 3 then 1.

Package C: It contains programming errors. Drill and practice, it says, is offered in any of the four basic arithmetic operations, but it has no minus or oblique signs. Inspection of the program reveals that it chooses at random between offering you $+$ or $*$. Selection of another of its options results in the screen message "DIVISION BY ZERO" followed by a program crash.

Package D: It claims to adjust the problems automatically to fit your ability. Indeed it does, but one typing error will strip the pupil of the honours of $78+94$ and reduce him to $1+2$. If you have a wrong answer, the correct answer appears for an interval of time over which you have no control. Spot your mistake in the next five seconds or —. If you have all the

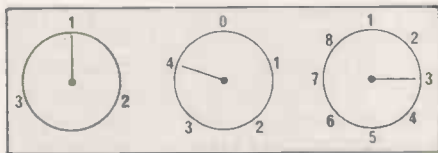

Figure 2.

sums right, a score of 87 percent appears. The summaries of a pupil's performance defied comprehension even when they were shown to a group of experienced maths teachers.

Package E: Will not allow the pupil to move to next sum until he obtains the correct answer for the present one. Schools who buy this package should doubly insure their computer.

Package F: The only package of our six to make anything but primitive use of the graphics. One face of each of two dice are displayed; each face has up to 12 dots. The pupil must add the numbers of dots on each face. If the number of dots on the right-hand die is zero, a programming error draws the right-hand die twice.

Package F is one of several programs available which offer pupils arithmetic drill and practice rather less formally than, say, presenting 20 multiplication sums. Often, there is a game to be played which involves two players — two pupils, boys v. girls — and offers the teacher a choice between working with the whole class and typing answers himself or sending two pupils off together, rather than just the one.

Perhaps the pre-eminent success in this area is the program Jane from ITMA at

the College of St Mark and St John, Plymouth. Jane will be available soon for both 380Z and Pet and possibly others. The computer — operated at the front of the class by the teacher on instructions from the pupils — gives two numbers, say, three and seven, and the pupils have to discover the relationship between the first and the second number which involves two arithmetic operations.

More number pairs can be called to verify or contradict an hypothesis from the children. The teacher can control which arithmetic operations are used to form the relationship. Simple but effective use of graphics adds an appealing human element.

Jane has a close relation in a game, How the West was won, which is unavailable on microcomputers, at least from commercial sources. It was invented up by one of the members of the Plato project team. The board for the game appears in figure 1.

The object of the game is to land exactly on 70 and there are two players — represented on the computer screen by a \square and a X . At each turn, the computer presents three numbers on three dials — figure 2.

The player whose turn it is to move may combine three numbers — 1, 4 and 3 — in any way using only one each of the four basic arithmetic operations, and possibly parentheses. Thus, the actual move of the player's counter on the board may be $2 (= 1 + (4 - 3))$ or $13 (= 1 + (4 * 3))$ or $15 (= (1 + 4) * 3)$ — of course, the teacher could vary what is allowed. That part provides the drill and practice, but strategy is involved, too, since there are other rules to make it more interesting:

- Towns occur every 10 spaces. If you land on a town you advance automatically to the next one.
- There are shortcuts, e.g., landing on four allows you to slide down to 12.
- Landing on a space occupied by your opponent means he is bumped back two towns unless he is on a town.

Again the teacher can vary what is allowed for a particular teaching point or for the ability of the class.

Thus, the player who obtains 1, 4, 3 from the dials and is at present on space 28 on the board and whose opponent is on 29 has options which include move one and bumping his opponent back, move two and landing on a town, and move 13 and taking the shortcut.

Jane is based on what used to be called the discovery method of teaching. Instead of a teacher delivering rules and the pupils practising them, the pupils are allowed to discover the rules themselves. Perhaps the microcomputer would be helpful in discovery, the machine and teacher guiding the pupils. A typical example might be solving quadratic equations. The machine might request guesses of the solutions of

$$\square^2 + 6 = 5x \square$$

which are 2 and 3, and then ask for guesses for solutions of

$$\square^2 + 4 = 5x \square$$

which are 1 and 4, and so on until they realise that the sum of the solutions in each case is 5, and similarly for the product rule — the product of the solutions is always the number on the left-hand side.

We hope it will not be long before Logo is commercially available. Logo is a programming language which was designed by Seymour Papert of the Massachusetts Institute of Technology as a means of teaching children mathematics through programming. Edinburgh University has a version for the Terak micro.

However, there is an implementation of possibly the most famous part of the Logo system — the Turtle graphics — as part of the UCSD Pascal system for the Apple II. Perhaps two examples will serve to demonstrate Turtle graphics to those unfamiliar with this system.

Two commands drive an imaginary turtle across the screen; as it moves, it drags a pen along to produce a picture. At the start, the turtle is in the middle of the screen facing to the right. The first command has the form TURN(x) where x is a number.

Thus, TURN (90) would turn the turtle to face in a direction 90° anticlockwise from where it was facing previously. The other command is of the form MOVE(y) and moves the turtle y units in the direction it faces. Thus the program

```
MOVE (50)
TURN (120)
MOVE (50)
TURN (120)
MOVE (50)
```

will draw an equilateral triangle; the program

```
MOVE (65)
TURN (60)
MOVE (65)
TURN (60)
MOVE (65)
TURN (60)
MOVE (65)
TURN (60)
MOVE (65)
TURN (60)
MOVE (65)
```

will draw a hexagon and the program

```
MOVE (50)
TURN (144)
MOVE (50)
TURN (144)
MOVE (50)
TURN (144)
MOVE (50)
TURN (144)
MOVE (50)
TURN (144)
MOVE (50)
TURN (144)
MOVE (50)
TURN (144)
MOVE (50)
TURN (144)
MOVE (50)
```

will draw the pentagram

Judged even by three very basic criteria, it seems harder to produce good commercial software for mathematics teachers than might otherwise be suspected. What is available seems to lack, among other things, enough thought and originality at the design stage and enough careful error checking at the programming stage. \square

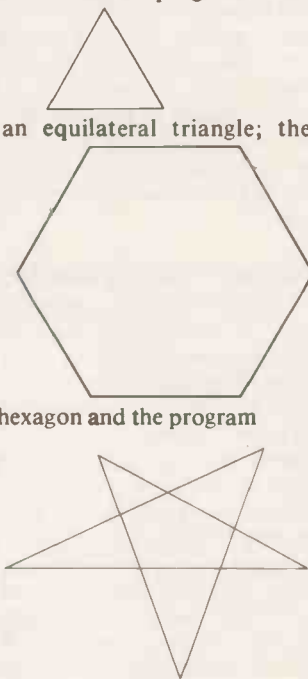

How to format invoices and letters printed from screen

Rex Tingey demonstrates the formatting of an invoice printed directly from the screen using the Commodore printer and then letter printing directly from the screen. He also reveals a letter-writing technique using a line-by-line approach, and a circular writer.

THE technique of transferring a full screen of information directly to the printer is extremely useful since all the information can be checked and corrected before the transfer takes place, ensuring a correct invoice or letter is printed.

With my technique, the whole screen is not transferred since some space must be left for the transfer commands and statements — only the bottom few lines are required for this purpose. By extra internal programming, the information can be transferred with formatted lines included here and there for the invoice, the lines of which need not appear on the screen, but are positioned correctly on the final print-out.

With the letter-to-screen transfer, the text can be formatted as either a 40-symbol line, as on the screen, or as a double-screen line of 80 symbols, printed-out on the printer as a single line.

Both the screen-to-printer programs use double quotes as field terminators; whenever the quote symbol appears on the screen, the program will automatically stop transferring information. The quote symbol is used as there is little reason to use the symbol, any quotation required can use the single mark symbol, ', next to the % key, as is required within a program.

Information gathering

The method used to gather information from the screen is to peek each screen memory location, and to form character strings from the coded information discovered. Thus, the information could be all spaces — blank screen — and the string formed of those characters. When the length of the string is complete, the string information is sent to the printer before the next line-set is read from the screen locations.

The transfer process is started by GOTO 200, but if that is written within the print-effective screen area, being read, the command will not be obeyed but printed on the printer. If the GOTO 200 is written on the screen print-effective area and a carriage return made, the whole effective area, including the command will print-out.

Through all the string formation process, a search is made for the double-quote character, which, when found, halts the string formation and the printing. So, double quotes followed on the next line by

the GOTO 200, and a carriage return will terminate without the command printing-out.

Use two double quotes to take the screen from the quote mode. Otherwise take the cursor down to the first non-printing line, and carriage return over the preformed statement and command.

The # symbol is also searched for during the string formation; that is so that it can be changed to the pound sign whenever it is encountered. That is particularly useful in business programs where constant use is made of the sign, but where a dollar sign may also sometimes be required.

The circular and the line-by-line programs provide different methods of letter writing. The line-by-line presents a simple screen presentation for typing one line of a letter but after the program has already printed-out a letter-head and the date.

Personal heading

That method of letter writing may be preferred for letters printed with a carbon copy, when the printing program is not required to be saved, on tape or disc. The line information for the previous line is lost as each new line is written and printed.

The information for the personal heading is programmed in open-block form to be transformed into the required letters of the alphabet, as shown, to give a bold presentation. Any of the commercial-print programs could have that type of bold header inserted.

The circular letter program requires a letter to be typed, where it is saved on a definite line or step number, as print information. When the letter is complete and run, the printer continues printing letters until all clients have been printed one copy each, according to the data listing. The program can be saved on tape or on disc, complete with letter and list, but with the line-numbering, first part, cancelled.

The first writes formatted invoices directly from the screen, with a personal heading on each invoice. The day's date need be entered only once, at the first use of the program during the day. The program turns over for each new invoice, leaving the date intact.

Only one printed copy is obtained, and a carbon copy system should be used where duplicates are required. The pound sign is printed wherever the # sign is en-

countered on the screen. The arrows of the display show the right limits of the written text, and the space behind the arrows used for the monetary amounts, overwriting all the information text at the top of the screen.

First homing the cursor will always make available the maximum usable screen area. The format on the printer gives double-spacing throughout, and so double-spacing on the screen should be avoided, particularly between the invoiced items.

Overwrite down to the "0=1:GOTO 200" only, giving a carriage return on that line, which gives a continuation of the invoice. Writing the double quotes on a line for termination, GOTO200 and carriage returned will print-out and also draw the terminating formatting line across. To draw the same line after printing a full screen, write GOTO700 and C-Return.

On the screen, use only upper-case, figures and shifted-figure graphics, or an error may result — usually the printout of no symbol a shift to the right of the next symbol. Do not make a carriage return while typing to the screen, or a syntax error will result. However, if that does occur, the cursor can be lifted and the error characters overwritten before any transfer is made.

Direct program

A program similar to the invoice one, but without the line formatting. The program prints a personal heading and the date, as entered, before offering the screen for typing, apart from the bottom transfer lines, and when the screen is overwritten, the text can be transferred to the printer. The program re-starts at the beginning, so that the date must be re-entered for the next letter.

Either a 40-character line, or a double, 80-character line can be selected for print-out. Remember, the first line of the first pair of lines, when printing 80-character lines on the printer, starts with a home cursor, otherwise the wrong lines will pair together. Otherwise, the rules are the same as for the invoice.

The line-by-line program first writes a personal heading and the entered date. Then a line is screened for overwriting after a string symbol, equals, and quotes. That can then be transferred for printing on the printer, to write the letter, one line at a time. When the written line is carriage-

“If you want what’s best for your PET, choose Commodore software.”



Kit Spencer
General Manager
of Commodore Systems
360 Euston Road
London NW1 3BL

The Commodore PET is Britain’s best selling micro-computer, with over 10,000 already installed in a wide range of fields, including Education, Business, Science and Industry.

This has led to a tremendous demand for high quality software.

And Commodore has met this demand by producing a first class range of programs, now available from the nationwide network of Commodore Dealers.

Commodore’s support also includes training courses, a Users’ Newsletter and Official Approval for compatible products of other manufacturers who reach agreed standards.

COMMODORE PETPACKS

Over 50 Petpacks of programs are available (mainly on cassette) from Commodore Dealers. These cover such popular titles as Strathclyde Tutorial, Statistics pack 1, Assembler Development System, Stock Market Trends and the Treasure Trove Collection of game packs including the award winning Star Trek, which is packaged with Petopoly. Prices are from £5 to £50.

TRAINING COURSES AND SEMINARS

PET systems are simple to use and any normal advice or assistance

OZZ The PET Information Wizard

The Wizard - OZZ is the first computer program ever to give you real freedom to tackle your problems in your own way.

That is made possible because OZZ is an advanced information system capable of ‘magical’ transformation allowing you to perform an almost limitless range of tasks.

It has intelligent features that let you decide its working parameters.

You choose what information to store, what calculations to make, how reports and lists are printed and so on. Even if you’ve never been near a computer before, the Wizard will help you set OZZ to meet your individual requirements.

you may need can be obtained from Commodore Dealers.

On the other hand, for rapid training on a basic or advanced level, you will certainly be interested in Commodore’s intensive 2 and 3 day residential courses. We also run one day general appreciation seminars.

PET USERS’ NEWSLETTER

This is Commodore’s official method of sharing new information and ideas between the many thousands of PET users. The newsletter is published regularly and for an annual subscription of £10 you can start receiving copies now.



Look out for this sign. It tells you that compatible products of other manufacturers have met with our standards of approval.



(Tick the appropriate boxes)

To: Commodore Information Centre, 360 Euston Road, London NW1 3BL 01-388 5702

I am a PET owner Please put me in touch with my nearest dealer

Please send me details of: Commodore PET Software

Training Courses & Seminars I would like to receive the Users’ Newsletter and enclose £10 annual subscription

PC 1/81

Name _____

Address _____

Tel. No. _____

commodore

We made small computers big business.



(continued from page 87)

```

802 PRINT "PRESS CLEAR/HOME : OVERWRITE TO↑+      GOTO200 ONLY".; " ↑"
808 CLOSE4:END
1000 X=32768+Z:A=PEEK(X):IFA=35GOTO1010
1004 IFA=34GOTO700
1006 A=A+64:A#=CHR$(A):B#=B#+A#:GOTO1020
1010 B#=B#+CHR$(254)
1020 RETURN
1100 X=32768+Z:A=PEEK(X):IFA=35GOTO1110
1104 IFA=34GOTO700
1106 A=A+64:A#=CHR$(A):C#=C#+A#:GOTO1120
1110 C#=C#+CHR$(254)
1120 RETURN
2000 OPEN5,4,5:DATA9,63,73,73,65,33:FORP=1TO6:READQ:Q#=Q#+CHR$(Q):NEXT
2010 PRINT#5,Q#:RETURN
3000 PRINTSPC(4)"SCREEN TO PRINTER ■ DIRECT INVOICE
3010 RETURN

```

SCREEN TO PRINTER ■■■■■■■■■■

```

1 R=0:S=39:CLOSE5:GOSUB2000:PRINTSPC(4)"SCREEN TO PRINTER ■ DIRECT
2 PRINT"### A PROGRAM TO TRANSFER SCREEN CONTENT
4 PRINT"### DIRECT TO THE PRINTER, WITH EITHER ONE
6 PRINT"### LINE OR A DOUBLE 80 CHAR LINE PRINTED.
8 PRINTSPC(10)"*****
10 PRINT"### USE NO GRAPHICS, NOR PRINTER UPPER/LOWER
12 PRINT"### CASE, OR ERROR WILL HALT PROGRAM.
14 PRINTSPC(10)"*****
16 PRINT"### FOR 40 CHAR LINE PRESS 1 - 80 PRESS 2.
18 PRINT"### USE QUOTES IN FIELD TO TERMINATE PAGE.
20 PRINT"### COPYRIGHT(C)REX L TINGEY:JAN'80
30 GETJ1:IFJ1=0GOTO30
100 B#="" : C#="" : OPEN4,4:PRINT#4
110 PRINT#4,,CHR$(1)CHR$(1)"PERSONAL HEADING HERE
130 PRINT#4,,
140 PRINT#4,, "      YOUR ADDRESS GOES IN HERE WITH SPACES TO MATCH HEADING
150 PRINT#4,,
160 PRINT#4:PRINT#4:PRINT#4:CLOSE4:GOTO800
200 FORZ=RTOS:GOSUB1000:NEXT:R=R+40:S=S+40
210 FORZ=RTOS:GOSUB1100:NEXT:OPEN4,4:IFJ1=2THENPRINT#4,B#C#:GOTO240
230 PRINT#4,,B#:PRINT#4,,C#
240 A#="" : B#="" : C#="" : CLOSE4:R=R+40:S=S+40:IFSO>770GOTO700
250 GOTO200
700 R=0:S=39:END
800 PRINT"#####GOTO200:REM-CURSOR ON THIS LINE-RETURN
801 PRINT"PRINTS THE ABOVE ON PRINTER.(#=POUND)S
802 PRINT"PRESS CLEAR/HOME : OVERWRITE DOWN TO THEGOTO200 ONLY
804 IFJ1=2THENPRINT"#####(80 PRINT SELECTED)":GOTO808
806 PRINT"#####(40 PRINT SELECTED)
808 END
1000 X=32768+Z:A=PEEK(X):IFA=35GOTO1010
1003 IFA=34GOTO1
1006 A=A+64:A#=CHR$(A):B#=B#+A#:GOTO1020
1010 B#=B#+CHR$(254)
1020 RETURN
1100 X=32768+Z:A=PEEK(X):IFA=35GOTO1110
1103 IFA=34GOTO1
1106 A=A+64:A#=CHR$(A):C#=C#+A#:GOTO1120
1110 C#=C#+CHR$(254)
1120 RETURN
2000 OPEN5,4,5:DATA9,63,73,73,65,33:FORP=1TO6:READQ:Q#=Q#+CHR$(Q):NEXT
2010 PRINT#5,Q#:Q#="" : RESTORE:RETURN

```

(continued on page 91)

Now you can control your business for less than £2,500.

This could be your best investment opportunity yet. A complete computerised business system, including a Floppy Disk Unit, high-speed Printer and *Britain's best selling microcomputer* – the Commodore PET. All for under £2,500.

First Class Programs

A comprehensive range of first class programs is offered by *Commodore 'Business Software' Dealers*. These are available on disk from £50-£500. And they cover such applications as *Business Information, Stock Control, Word Processing, Payroll, Accounting and Mailing Systems*.

Service and Support

With over 10,000 PET computers installed in the UK, dealer support is growing fast. A nationwide network of 90 official

Commodore 'Business Software' Dealers ensures that service and technical facilities are close to every PET user. Our dealers can even offer you a 24 hour on-site maintenance agreement.

Training and Instruction

The PET Business System is self-contained and simple to use. Should you require personalised programs or extensive installation training this can be arranged with your *Commodore 'Business Software' Dealer* who can also give details of official *Commodore Training Courses*. These include intensive 2 & 3 day workshops to train you to write your own programs.

For full details about the Commodore PET Business System, Training Courses, Programs, and *'Business Software' Dealers*, simply fill in the coupon and post today.



To: Commodore Information Centre,
360 Euston Road, London NW1 3BL

Please send me details of the PET Computer Business Systems.

Name _____
Position _____
Company _____
Address _____

Tel. No. _____

If you have a particular application in mind please specify:

PCB1/81

commodore
We made small computers big business.

• Circle No. 167

(continued from page 89)

LINE-BY-LINE

```

10 TI#="000000" PRINT"0000 LINE BY LINE WITH LETTER-HEAD
20 PRINT"PROGRAM TO PRINT LETTER LINE-BY-LINE
30 PRINT"WITH FULL PRINTER GRAPHICS USING CURSOR
40 PRINT"UP AND DOWN, NO POUND SIGN THIS TIME!
50 PRINT"1000 LINE OF DOTS GIVES LIMIT OF LINE, BUT
60 PRINT"PLEASE 3 OTHER SIGNS WILL SHORTEN PRINTED
70 PRINT"LENGTH. SO USE INSERT TO ASSIST.
80 PRINT"NON-COPYRIGHT (C) REX L TINGEY JAN '80
90 IFTI#<"000000" GOTO 90
95 PRINT"0000100000" PRINT"CURSOR UP AND TYPE (ENTER) RETURN HOME (C) SPACE RETURN
98 PRINT"NON" LIST155
100 OPEN#4:PRINT#4:"OPEN#4:4:PRINT#6:CHR$(18)
    
```

```

106 PRINT#4:"NON 0000 0000 0000 0000 0000 0000 0000 0000 0000 0000 0000 0000 0000 0000 0000
110 PRINT#4:"NON 0000 0000 0000 0000 0000 0000 0000 0000 0000 0000 0000 0000 0000 0000
120 PRINT#4:"NON 0000 0000 0000 0000 0000 0000 0000 0000 0000 0000 0000 0000 0000 0000
130 PRINT#4:"NON 0000 0000 0000 0000 0000 0000 0000 0000 0000 0000 0000 0000 0000 0000
140 PRINT#4:"NON 0000 0000 0000 0000 0000 0000 0000 0000 0000 0000 0000 0000 0000 0000
148 PRINT#4:"NON 0000 0000 0000 0000 0000 0000 0000 0000 0000 0000 0000 0000 0000 0000
150 PRINT#4:"NON YOUR ADDRESS GOES IN HERE WITH SPACES TO MATCH HEADING
151 PRINT#4:"NON 0000 0000 0000 0000 0000 0000 0000 0000 0000 0000 0000 0000 0000 0000
152 PRINT#6:CHR$(80)
155 PRINT#4:"NON *****
160 PRINT#6:CHR$(80) POPI=1TO2 PRINT#4: NEXT
180 GOTO 150
200 PRINT"NON" PRINT"CHR$(34)Z#
220 PRINT"NON" PRINT#4:"AF REM-JUST RETURN OVER THESE 3
200 PRINT#60 PRINT"CHR$(34)Z# PRINT#60
10000 REM-ABDIDS FILE NOT OPEN ERROR
    
```

LETTER WRITER

```

1 GOSUB 20000:PRINT"CENTER DATE-NO PUNCTUATION":INPUT Z#:A=198:L=9:GOTO 4
2 PRINT"0":PRINT"0CANCEL WITH RETURN(000)":PRINT"1"....."2"....."3"....."4"....."5"
3 PRINT"6"....."7"....."8"....."9"....."RUN(0)":STOP
4 PRINT"000":B=0:A=A+2:B=B+1:IFL>5THENPRINT"155 PRINT#4....."CHR$(34)Z#
5 L=0:A=A+2:B=B+1:IFB=11GOTO 7
6 PRINT#4:"PRINT#4.....".....".....":GOTO 5
7 PRINT"A="A"-4:GOTO 4":PRINT"GO TO 2:REM-CHR$(254)=POUND#(0)":IFA>210GOTO 9
8 IFA<210THENPRINT"0CHECK DATE & RETURN(0)"
9 END
50 OPEN#4,5:DATA 9,63,73,73,65,33:IF0=1GOTO 100
60 FORA=1TO6:READ Z:Z#=Z#+CHR$(Z):NEXT:PRINT#5,Z#
100 Q=1:OPEN#4:4:PRINT"0":PRINT#4
110 PRINT#4:TAB(10)CHR$(1)" PERSONAL HEADING HERE"
140 PRINT#4:," FOLLOWED BY YOUR ADDRESS AND OTHER DETAILS":PRINT#4
200 PRINT#4:READ A#:PRINT#4:,"(DEAR) "A#":PRINT#4
5000 PRINT#4:PRINT#4:PRINT#4....."YOURS FAITHFULLY"
9000 FORS=1TO 10:PRINT#4: NEXT
10000 CLOSE#4:CLOSE#5:CLOSE#6:P=P+1:IFP<260GOTO 50
10010 END
10000 TI#="000000":PRINT"0000 CIRCULAR LETTER "
20010 PRINT"NON THIS PROGRAM PROVIDES A FACILITY FOR
20020 PRINT"NON WRITING A CIRCULAR LETTER TO BE SENT TO
20030 PRINT"NON THE CUSTOMERS WHOSE NAMES ARE DATA AT
20040 PRINT"NON THE END OF THE PROGRAM, EACH NAME PRINTS
20050 PRINT"NON IN ONE LETTER, IN ORDER, MAKING THE
20060 PRINT"NON MAILING SIMPLE- USE AN ADDRESS LABELLING
20070 PRINT"NON SYSTEM TO ADDRESS YOUR ENVELOPES.
20072 PRINT"NON CIRCULAR WRITING SAME AS SAVE A LETTER"
20074 PRINT"NON IN RUN AND WRITE DETAILS.
20080 PRINT"NON COPYRIGHT (C) REX L TINGEY JAN '80
20090 IFTI#<"000000" GOTO 20090
20100 RETURN
30000 DATA"MR ARMSTRONG"
30100 DATA"MR BENNETT"
30200 DATA"MR & MRS DEWRIGHT"
30300 DATA"MR DUNHAM"
30400 DATA"J.H. EARLING & SONS"
30500 DATA"MR CHARLES & LADY FOLKES"
30600 DATA"MR GATLING"
30700 DATA"MR HENDERSON"
30800 DATA"MR & MRS HINGLE"
30900 DATA"R.V. JOHNSON & COMPANY"
31000 DATA"MR KING"
31100 DATA"MR LONGFELLOW"
31200 DATA"MR MADDOX"
31300 DATA"MISS MIGHTINGALE"
31400 DATA"MR DOLIPHANT"
31500 DATA"MISS MINGY"
31600 DATA"MR MONTGOMERY"
31700 DATA"MR ROBINSON"
31800 DATA"MISS SINGLETON"
31900 DATA"LORD THOMPSON"
32000 DATA"MR TOWN"
32100 DATA"MR VINCENT"
32200 DATA"LADY WINDMERE"
32300 DATA"XL STEEL COMPANY"
32400 DATA"VANKEE WISH LIMITED"
32500 DATA"MR & MRS ZODOT"
    
```

Buy a microcomputer for under £1,000 and you could be on your own! Unless it's a Commodore PET.



Commodore produce Britain's number one microcomputer. But we don't stop there. We also insist on providing comprehensive support throughout our national dealer network.

Our dealers can examine your needs and demonstrate which hardware and software will suit you best. Their trained engineers are always at hand and a 24-hour field maintenance service is available. Your local dealer can tell you more about the following Commodore Services.

The Commodore PET
The Commodore PET computer range covers everything from the self-contained unit at under £500 to complete business systems at under £2,500.

Commodore Business Software and Petpacks
Our software range covers hundreds of applications. Business software includes Sales and Purchase Ledgers, Accounting, Stock Control, Payroll, Word Processing and more. In addition over 50 Petpacks are available covering such titles as Strathclyde Basic Tutorial, Assembler Development System, Statistics, plus our Treasure Trove and Arcade series of games.

Commodore Approved Products
Compatible products of other manufacturers with Commodore's mark of approval are also available.

Commodore Courses
Commodore offer a range of residential training courses and one day seminars. An excellent start. And when you have installed your system the PET User's Club Newsletter can keep you informed of new ideas and latest developments.

LONDON AREA

Adda Computers Ltd,
WS. 01-579 5845
Advanced Management Systems,
EC2. 01-638 9319
Byteshop Computerland,
SW1. 01-636 0647
C.S.S. (Business Equipment) Ltd,
E8. 01-254 9293
Capital Computer Systems,
W1. 01-636 3863
Centralex-London Ltd,
SE13. 01-318 4213
Cream Microcomputer Shop,
HARROW. 01-863 0833
Da Vinci Computer Shop,
EDGWARE. 01-952 0526
L & J Computers,
NW9. 01-204 7525
Home and Business Computers,
E12. 01-472 5107
Merchant Systems Limited,
EC4. 01-353 1464
Metyclean Ltd,
SW1. 01-828 2511
Micro Computation,
N14. 01-882 5104
Micro Computer Centre,
SW14. 01-878 3206
Sumlock Bondain Ltd,
EC1. 01-250 0505
Sumlock Bondain Ltd,
EC4. 01-626 0487
T.L.C. World Trading Ltd,
WC2. 01-839 3894
TOPSTV LTD,
SW1. 01-730 1795

HOME COUNTIES

G. M. Marketing,
ANDOVER, 790922
HSV Microcomputers,
BASINGSTOKE, 62444
MMS Ltd,
BEDFORD, 40601
Elex Systems Ltd,
BRACKNELL, 52929
DDM Direct Data Marketing Ltd,
BRENTWOOD, 229379
Amplicon Micro Systems Ltd,
BRIGHTON, 562163
RUF Computers (UK) Ltd,
BURGESS HILL, 45211
T & V Johnson (Microcomputers
Etc) Ltd, CAMBERLEY, 20446
Cambridge Computer Store,
CAMBRIDGE, 65334
Wego Computers Ltd,
CATERNAM, 49235
Dataview Ltd,
COLCHESTER, 78811
South East Computers Ltd,
HASTINGS, 426844
Alpha Business Systems,
HERTFORD, 57423
Brent Computer Systems,
KINGS LANGLEY, 65056
Isher-Woods Business Systems,
LUTON, 416202
South East Computers Ltd,
MAIDSTONE, 681263
Micro Facilities Ltd,
MIDDLESEX, 01-979 4546
J. R. Ward Computers Ltd,
MILTON KEYNES 562850
Sumlock Bondain (East Anglia) Ltd,
NORWICH, 26259
T & V Johnson (Microcomputers
Etc) Ltd, OXFORD, 721461
H.S.V. Microcomputers,
SOUTHAMPTON, 22131
Super-Vision,
SOUTHAMPTON, 774023
Xitan Systems Ltd,
SOUTHAMPTON, 38740
Stuart R Dean Ltd,
SOUTHEND-ON-SEA, 62707
The Computer Room,
TUNBRIDGE WELLS, 41645
Orchard Electronics,
WALLINGFORD 35529

Petalect Ltd,
WOKING, 63901
Oxford Computer Systems,
WOODSTOCK, 811976

MIDLANDS AND SOUTH HUMBERSIDE

Byteshop Computerland,
BIRMINGHAM, 622 7149
CPS (Data Systems) Ltd,
BIRMINGHAM, 707 3866
Camden Electronics,
BIRMINGHAM, 773 8240
Computer Services Midlands Ltd,
BIRMINGHAM, 382 4171
Callands (Computers) Ltd,
BURTON-ON-TRENT, 812380
Ibex Systems,
COVENTRY, 86449
Jondane Associates Ltd,
COVENTRY, 664400
Davidson-Richards Ltd,
DERBY, 366803
Caddis Computer Systems Ltd,
HINCKLEY, 613544
H.B. Computers,
KETERING, 83922
Taylor-Wilson Systems Ltd,
KNOWLE, 6192
Machsize Ltd,
LEAMINGTON SPA, 312542
Office Computer Techniques Ltd,
LEICESTER, 28631
Lowe Electronics,
MATLOCK, 2817
Betos (Systems) Ltd,
NOTTINGHAM, 48108
Byteshop Computerland,
NOTTINGHAM, 40576
Keen Computers Ltd,
NOTTINGHAM, 583254
Tekdata Computing,
STOKE-ON-TRENT, 813631
Systems Micros,
YELFORD, 460214
McDowell Knaggs & Associates,
WORCESTER, 427077

YORKSHIRE AND NORTH HUMBERSIDE

Acronym Typewriter & Adding
Machine Co. Ltd, BRADFORD, 31835
Allen Computers,
GRIMSBY, 40568
Microware Computers Ltd,
HULL, 562107
Microprocessor Services,
HULL, 23146
Holdene Ltd,
LEEDS, 459459

South Midlands Communications Ltd,
LEEDS, 782326
Yorkshire Electronics Services Ltd,
MORLEY, 522181
Computer Centre (Sheffield) Ltd,
SHEFFIELD, 53519
Electronic Services,
SHEFFIELD, 668767
Hallam Computer Systems Ltd,
SHEFFIELD, 663125

NORTH EAST

Dyson Instruments,
DURHAM, 66937
Currie & Maughan,
GATESHEAD, 774540
Wards (Office Supplies) Group,
GATESHEAD, 605915
Elton Ltd,
HARTLEPOOL, 61770
Fiddes Marketing Limited,
NEWCASTLE, 81517
Newcastle Computer Services,
NEWCASTLE, 615325
Format Micro Centre,
NEWCASTLE, 21093
Tripart Associated Systems
Consultants Ltd,
SUNDERLAND, 73310

SOUTH WALES AND WEST COUNTRY

Radan Computational Ltd,
BATH, 318483
Computer Corner,
BAYSTON HILL, 4250
Bristol Computer Centre,
BRISTOL, 23430
C.S.S. (Bristol) Ltd,
BRISTOL, 779452
T & Johnson (Microcomputers
Etc) Ltd, BRISTOL, 422061
Sumlock Tabdown Ltd,
BRISTOL, 25685
Sigma Systems,
CARDIFF, 34869
Office and Business Equipment
(Chester) Ltd, DEESIDE, 817277
A.C. Systems,
EXETER, 71718
Micro Media Systems,
NEWPORT, 59276
J.M. Computer Services Ltd,
NEWQUAY, 2863
Devon Computers,
PAIGNTON, 526303
J.A.D. Integrated Services,
PLYMOUTH 62616
Business Electronics,
SOUTHAMPTON, 738248
Computer Supplies (Swansea),
SWANSEA, 290047

NORTH WEST AND NORTH WALES

Tharstern Ltd,
BURNLEY, 38481
B + B (Computers) Ltd,
BOLTON, 26644
Preston Computer Centre,
PRESTON, 57684
Catlands (Computers) Ltd,
WILMSLOW, 527166

LIVERPOOL

Aughton Microsystems Ltd,
LIVERPOOL, 548 7788
B.E.C. Computers,
LIVERPOOL, 263 5738
Rockcliff Brothers Ltd,
LIVERPOOL, 521 5830

MANCHESTER AREA

Byteshop Computerland,
MANCHESTER, 236 4737
Computastore Ltd,
MANCHESTER, 832 4761
Cytek (U.K.) Ltd,
MANCHESTER, 872 4682
Executive Reprographic Ltd,
MANCHESTER, 228 1637
N.S.C. Computer Shops Ltd,
MANCHESTER, 832 2269
Sumlock Electronic Services
(Manchester) Ltd,
MANCHESTER, 834 4233
Professional Computer Services Ltd,
OLDHAM, 624 4065
D. Kipping Ltd,
SALFORD, 834 6367
Automated Business Equipment Ltd,
STOCKPORT, 061-432 0708

SCOTLAND

Holdene Microsystems Ltd,
EDINBURGH, 668 2727
Microcentre,
EDINBURGH, 556 7354
Aethrol Consultancy Services,
GLASGOW, 641 7758
Byteshop Computerland,
GLASGOW, 221 7409
Robox Ltd,
GLASGOW, 221 5401
MacMicro,
INVERNESS, 712203
Thistle Computers,
KIRKWALL, 3140

IRELAND

Softech Ltd,
DUBLIN, 784739
Medical & Scientific Computer
Services Ltd, LISBURN, 77533

To: Commodore Information Centre,
360 Euston Road, London W1 3BL. 01-388 5702

Please send me further information about the Commodore PET.

Name

Position

Address

Intended application PC/D 1/81

Do you own a PET? YES NO

commodore

This list covers dealers participating in our advertising.

Serial-printer drive routine for Tandy TRS-80

ONE OF the attractive features of the TRS-80, after the pleasure of finding that you have 16K of usable RAM and 12K of Basic for less than the price of an 8K Brand X, is the ease with which a printer can be driven.

There is not much doubt that a printer is the first essential accessory, assuming that you start with a reasonable amount of RAM. The low-price printers, such as the Nascom Imp or the Epson are serial printers. The natural companion to the TRS-80 is the Centronics, which uses a parallel port, but the Centronics costs considerably more than a complete TRS-80, and if it happens to carry the Radio Shack label, it may cost even more.

Fortunately, serial printers can be interfaced to the TRS-80 through the cassette port, using a very simple interface consisting of little more than a 741 integrated circuit, a rectifier bridge, and a few resistors and capacitors. The total cost of the interface, if you build it yourself, is about £2.

If you are not in the hardware business, however, you will be asked for about £40

by Ian Sinclair

for an interface which presumably must use a very expensive plug and socket. Some of the cost of the commercial effort is the software which accompanies it, because the use of the cassette port for serial printer output is not one of the considerations which Tandy had in mind when it assembled its package.

There are many serial-printer drive programs, ranging from a bare 100 bytes all the way to fully-fledged printer, screen and keyboard controllers, like the excellent KVP Extender from Microcomputer Applications.

I wanted more than a straightforward routine, because I like to keep listings as I develop programs and nothing is more awkward than keeping long rolls of paper. Since I keep the original program notes on A4 and in A4 files, it seems logical to keep the listings there as well, which means that I needed a left-hand margin, to allow room for the punch-holes.

As the Nascom Imp printer starts well over to the left-hand side on listings, that obviously was a software task. In addition, using A4 files meant that the listing should be in groups of 66 lines, so that I could divide the Teletype roll into pages. That in turn meant a lines-per-page counter in software which could be re-set so that I could set top-of-page when I started a listing, instead of having to accept a

random number of lines before a page break.

At that point in the specification, a few bells and whistles started to be added. I wanted to be able to slow down the listing on the screen with a simple command — I hate having to poke numbers into memory — just as that other computer does, and I wanted the usual keyboard delay because my TRS-80 is an old one with keybounce.

To make the specification more awkward, I originally wanted the program re-locatable, so that I could place it anywhere in memory. There was only one way of obtaining all this, and that was to write the program myself.

Since the TRS-80 uses the Z-80 CPU, there is a version of the Zen assembler-editor-debugger available for it. If there are still people who run Z-80 machines

and have not encountered Zen, I believe it is the best editor/assembler package available.

It is simple to use — which means that you can stop thumbing through the instructions after a few hours, which means I make for more use of it than of the package I used before.

As an assembler/editor, it is very versatile, allowing quick and easy assembler program writing without having to watch the size of spaces or the length of label-names; editing is very simple. It even permits assembler programs to be combined from tape, and, of course, writes object code tapes in TRS-80 standard code.

In addition, Zen has full monitor facilities, allowing you to read machine-code

(continued on next page)

Figure 1.

```

1      !LPRINT ROUTINE WITH LHS MARGIN
2      !66 LINES/PAGE AND 72 CH/LINE
3      ORG 7F11H
4      LOAD 6F00H
5      CHRSLN: EQU 4029H
6      LNFGE: EQU 4028H
7      7F11 E5          PUSH HL
8      7F12 21347F     LD HL,LPRT
9      7F15 222840     LD (4028H),HL
10     7F18 21F27F     LD HL,KBFIX
11     7F1B 221E40     LD (401EH),HL
12     7F1E 2ADE7F     LD HL,(CHRLN)
13     7F21 222940     LD (4029H),HL
14     7F24 21DF7F     LD HL,TOFFAC
15     7F27 227D41     LD (417DH),HL
16     7F2A 21E77F     LD HL,DELAY
17     7F2D 228341     LD (4183H),HL
18     7F30 E1        POP HL
19     7F31 037200     JF 0072H
20     7F34 F3        LPRT: DI
21     7F35 79        LD A,C
22     7F36 F5        PUSH AF
23     7F37 D5        PUSH DE
24     7F38 F0E5     PUSH IY
25     7F3A 0D3300     CALL 0033H
26     7F3D FDE1     POP IY
27     7F3F D1        POP DE
28     7F40 F1        POP AF
29     7F41 FE0D     ENILN: CP 0DH
30     7F43 2805     JR Z,RELOAD
31     7F45 FE20     CP 20H
32     7F47 D8        RET C
33     7F48 181C     JR START
34     7F4A E5        RELOAD: PUSH HL
35     7F4B F5        PUSH AF
36     7F4C 21DE7F     LD HL,CHRLN
    
```

(continued on next page)

(continued from previous page)

tapes, examine the contents, change code, copy tapes, copy code from one memory location to another — which is why I like re-locatable programs — and it can even load code into memory as it is assembled, without having to make a tape first.

I used Zen to create the assembler program of figure 1 which is why the line numbers follow the 1,2,3 order and are placed at the start of each line, rather than the convention used by Radio Shack. Those line numbers, incidentally, are not recorded when you tape an assembler program; they are allocated by Zen when the program is loaded, which is why programs can be merged, no matter what line numbers they used.

It does mean, though, that the Zen assembler tapes are not compatible with tapes created by a disassembler operating to Radio Shack standards.

The program is not annotated. Notes occupy a good deal of memory and tape, and I prefer to keep copious notes on a separate sheet. For the benefit of anyone who wants to modify the program either

for the TRS-80 or for another Z-80 based machine, here is an outline of the program operation.

The baud rate is set at 300, since that is the maximum rate recommended for a serial printer operated over a single line, with no provision for handshake — no signals can pass back from the printer to the computer to control the rate of transmission.

Program origin

The origin of the program as shown is 7F11H, 32529D, and two of the printer-control RAM addresses in the TRS-80 are used. They are, of course, not part of the 16K user RAM, but a separate section of about 3K of RAM which can be used for a remarkable range of control operations, and which are an Aladdin's cave for machine-language programmers.

Location 4029H (16525D) is used to store the number of characters per line, and 4028H (16524D) is used for the number of lines per page. Four addresses in the program space itself are also used, and they can be Poked so as to alter the

print format as desired. As set up, the program prints 72 characters per line and 66 lines per page, with six blanks between pages to allow for cutting.

The first section of the program from 7F11H to 7F2FH loads the locations in low RAM. 4026H is the address for the start of the printing routine. The address which is normally loaded into 4026H, 4027H is 058DH, the ROM routine for a parallel printer, and we have to substitute 7F34H, so that the LPRINT and LLIST commands of the TRS-80 direct the print commands to our routine starting at 7F34H. 401EH is the start address location for the screen-write routine, normally 0458H, but now changed to 7FF2H.

That allows us to put a delay into the screen-print routine, and performs two useful functions — it allows slow-listing to be controlled, and it also debounces the wretched keyboard of my old TRS-80 — new models seem to have a new keyboard with no bounce problems. The number of characters per line is loaded into 4029H; no figure is loaded into 4028H because it is set at 66 lines per page by the TRS-80

(continued from previous page)

37 7F4F 3A2940	LD	A,(CHRSLN)	91 7FB5 21DE7F	LD	HL,CHRLN
38 7F52 77	LD	(HL),A	92 7FB8 35	DEC	(HL)
39 7F53 21DC7F	LD	HL,LNCNT	93 7FB9 201D	JR	NZ,OUTS
40 7F56 35	DEC	(HL)	94 7FBB E1	POP	HL
41 7F57 200B	JR	NZ,RUN	95 7FBC F1	POP	AF
42 7F59 2A2840	LD	HL,(LNPGE)	96 7FBD 3E0D	LD	A,0DH
43 7F5C 02DC7F	LD	(LNCNT),HL	97 7FBF 1889	JR	RELOAD
44 7F5F 21DD7F	LD	HL,ENDFAG	98 7FC1 21DB7F	LD	HL,LHSPCE
45 7F62 3606	LD	(HL),06H	99 7FC4 3603	LD	(HL),03H
46 7F64 F1	RUN: POP	AF	100 7FC6 3E20	LD	A,20H
47 7F65 E1	POP	HL	101 7FC8 189F	JR	AGAIN
48 7F66 F5	START: PUSH	AF	102 7FCA 3ADB7F	TEST2: LD	A,(LHSPCE)
49 7F67 E5	PUSH	HL	103 7FCD B7	OR	A
50 7F68 C5	PUSH	BC	104 7FCE 28E4	JR	Z,OUT4
51 7F69 0609	AGAIN: LD	B,09H	105 7FD0 3D	DEC	A
52 7F6B 37	SCF		106 7FD1 32DB7F	LD	(LHSPCE),A
53 7F6C F5	PUSH	AF	107 7FD4 3E20	LD	A,20H
54 7F6D F5	PUSH	AF	108 7FD6 1891	JR	AGAIN
55 7F6E 2101FC	LD	HL,0FC01H	109 7FD8 E1	OUTS: POP	HL
56 7F71 CD2102	CALL	0221H	110 7FD9 F1	POP	AF
57 7F74 CD797F	CALL	DLY	111 7FDA C9	RET	
58 7F77 1809	JR	ROUND	112 7FDB 03	LHSPCE: DB	03H
59 7F79 21DE00	DLY: LD	HL,00DEH	113 7FDC 42	LNCNT: DB	42H
60 7F7C 2B	DLY1: DEC	HL	114 7FDD 00	ENDFAG: DB	00H
61 7F7D 7C	LD	A,H	115 7FDE 48	CHRLN: DB	48H
62 7F7E B5	OR	L	116 7FDF E5	TOPFAG: PUSH	HL
63 7F7F 20FB	JR	NZ,DLY1	117 7FE0 21DC7F	LD	HL,LNCNT
64 7F81 C9	RET		118 7FE3 3642	LD	(HL),42H
65 7F82 F1	ROUND: POP	AF	119 7FE5 E1	POP	HL
66 7F83 1F	RRA		120 7FE6 C9	RET	
67 7F84 F5	PUSH	AF	121 7FE7 F5	DELAY: PUSH	AF
68 7F85 3005	JR	NC,OUT1	122 7FE8 3AF67F	LD	A,(KBFIX+4)
69 7F87 2102FC	LD	HL,0FC02H	123 7FEB EE10	XOR	10H
70 7F8A 1805	JR	OUT2	124 7FED 32F67F	LD	(KBFIX+4),A
71 7F8C C600	OUT1: ADD	A,00H	125 7FF0 F1	POP	AF
72 7F8E 2101FC	LD	HL,0FC01H	126 7FF1 C9	RET	
73 7F91 CD2102	OUT2: CALL	0221H	127	ORG	7FF2H
74 7F94 CD797F	CALL	DLY	128 7FF2 F5	KBFIX: PUSH	AF
75 7F97 18E9	DJNZ	ROUND	129 7FF3 C5	PUSH	BC
76 7F99 2102FC	LD	HL,0FC02H	130 7FF4 012000	LD	BC,0020H
77 7F9C CD2102	CALL	0221H	131 7FF7 CD6000	CALL	0060H
78 7F9F CD797F	CALL	DLY	132 7FFA C1	POP	BC
79 7FA2 F1	OUT3: POP	AF	133 7FFB F1	POP	AF
80 7FA3 F1	POP	AF	134 7FFC C35804	JP	0458H
81 7FA4 FE0D	CF	0DH	135	END	
82 7FA6 2022	JR	NZ,TEST2			
83 7FAB 21DD7F	TEST1: LD	HL,ENDFAG			
84 7FAB AF	XOR	A	AGAIN 7F69	BLNK 7FC1	CHRSLN 4029
85 7FAC B6	OR	(HL)	DLY 7F79	DLY1 7F7C	DELAY 7FE7
86 7FAD 2812	JR	Z,BLNK	ENDFAG 7FDD	KBFIX 7FF2	LNPGE 4026
87 7FAF 35	DEC	(HL)	LHSPCE 7FDB	LNCNT 7FDC	OUT1 7F8C
88 7FB0 3E0D	LD	A,0DH	OUT3 7FA2	OUT4 7FB4	OUTS 7FDB
89 7FB2 18B5	JR	AGAIN	RUN 7F64	ROUND 7F82	START 7F66
90 7FB4 C1	OUT4: POP	BC	TEST2 7FCA	TOPFAG 7FDF	

SYMBOL TABLE

7FC1	CHRSLN	4029	CHRLN	7FDE
7F7C	DELAY	7FE7	ENDLN	7F41
7FF2	LNPGE	4026	LPRT	7F34
7FDC	OUT1	7F8C	OUT2	7F91
7FB4	OUTS	7FDB	RELOAD	7F4A
7F82	START	7F66	TEST1	7FA8
7FDF				

ROM when the machine is switched-on.

The remaining two loadings are luxury items. When a disc system is not in use — several commands, such as FIELD, PUT, GET etc., will return "L3 ERROR" if you use them in Basic. According to the manual, that is because they are Disc Basic commands, which can be used only with a disc system.

In fact, each one of those commands causes the ROM to look in RAM for the address of a routine, and if you poke in your own address and your own routine, you can make use of any of the commands — there are 28 of them from which to choose. In the program, I have used the FIELD command to re-set the printer program to top-of-page, so that it will print a full 66 lines before putting in its six blank lines.

Delay times

The address of a page-re-set routine at 7FDFH is, therefore, loaded into 417DH, the address for the FIELD command. Similarly, I have used PUT to change the delay time, by loading the address of a delay-byte insertion routine to 4183H. By typing PUT and entering from Basic, the TRS-80 screen-access speed is considerably slowed so that all operations which involve the screen are run at low speed and that obviously includes listing.

If the TRON command, part of standard TRS-80 Basic, has been entered, so that the line numbers are printed as the program executes, PUT allows me to watch a program executing in slow motion — a most useful debugging aid for elusive faults. Typing PUT for a second time and entering restores normal running speed.

That delay, incidentally, can also be implemented by using the keyboard address, but the screen routine is preferable, because the delay is then operative only when the screen is accessed — the keyboard is scanned continually, and any delay in the keyboard routine slows the computing rate considerably unless the keyboard is disabled during computing time. By this time, re-locatability was abandoned.

The loading section ends with a jump to 0072H, which returns to Basic. That is not the address given in the older Radio Shack manuals, incidentally. The address in the old manuals is not so suitable, and can cause error messages to appear; later editions give this correct address of 0072H.

The print routine starts at 7F34H, with a DI command so that the routine cannot be interrupted in mid-character by the break or any other key. The printer routines of the TRS-80 place the character byte in the C register, so that is transferred to the accumulator, A, for subsequent operations. The section of program from 7F36H to 7F40H saves registers, and calls the screen-print routine, so that whatever is printed is also echoed on the screen.

That is a useful feature, since most dot-

matrix printers conceal what is being printed. Curiously enough, that, along with the delay, causes odd effects — a "z" is printed in place of the least significant digit of the line number — when that routine is used along with Zen, so that the version of the program which I have tacked into Zen has 7F3AH and 7F3BH both set at 00, forming a set of NOP instructions.

At ENDLN, the byte in the accumulator is checked to see if it is a carriage return (0DH), in which case the program branches to RELOAD so as to re-set the memory location which governs the number of characters per line and to decrement the number-of-lines count in location LNCNT.

If at ENDLN, the byte in the accumulator has a value less than 20H and is not a carriage return, the program returns for the next character, since the other control characters are not used in this program. For any other character, the program jumps to START.

The registers are saved, and register B is loaded with a bit count — one byte plus a space. A mark bit is sent out by loading FC01 to HL and calling 0221H, which sends the bit in the L register to the cassette port. Incidentally, I have used 01 for mark and 10 for space, because this gives a much larger output signal than the conventional 01 and 00.

To establish the correct baud rate, a delay must follow, and that is achieved in the subroutine labelled DLY. The byte 00DEH which is loaded into HL for the delay subroutine determines the baud rate, so that if you are writing for 110 baud, a larger number must be loaded — try 0267H.

Carry position

At the label ROUND, the lowest bit of the byte is rotated into the carry position by the RRA command, and the other bits are similarly shifted in the accumulator. If the bit in the carry position is 0, C is re-set, and the program jumps to OUT1 to send a space bit. If the bit in the carry position is a 1, hl is loaded with FC02H, the space bit which is output by the routine at OUT2. Those routines are followed by the DLY subroutine to keep the baud rate correct.

The DJNZ command at 7F97H keeps the rotate-and-output routine going until the B-register is decremented to zero in the usual action of the DJNZ command. A final delay subroutine follows, and then at OUT3, which is the end of the main section of the print routine, the original unrotated byte is recovered and compared to the carriage return byte, 0DH. If the byte was a C/R, the program skips to TEST2, otherwise at TEST1 the byte from ENDPAG is loaded, and the accumulator is cleared.

Now if the lines-per-page count reached zero earlier in the program, at RELOAD, there will be a six in ENDPAG, so that the OR(HL) step will give a non-zero answer,

and the program will continue to decrement ENDPAG, load in a carriage-return character and run it through the print routine again until ENPAG is zeroed.

If the line/page count has not reached zero, the step at 7FADH directs the program to BLNK, where the store LHSPCE is loaded in with the number 3. The accumulator is loaded with the ASCII blank character, 20H, and the printing routine repeated, so that a space is printed at the left-hand side of the page.

That continues until the store LHSPCE is decremented to zero, giving the left-hand margin which prevents the listing from being mangled.

When the character in A is not a carriage-return, the test routine is TEST2. That tests for the byte in LHSPCE to see if more spaces need to be printed, otherwise the retreat is sounded by jumping to OUT4. At OUT4, the characters/line count is decremented and, if the count is zero, the accumulator is loaded with a carriage return character and re-cycled. If the byte is not at the end of a line, the next stage in the countdown is OUT5, where the registers are restored and the routine returns for the next character.

Storage bytes

The bytes from 7FDBH to 7FDEH are storage bytes for the left-space, lines/page, end-of-page space, and characters/line respectively. At TOPPAG, a short routine restores the lines/page count. That is the routine which is called by typing FIELD and entering. Similarly at 7FE7H, a short routine inspects the delay byte at 7FF6H and XORs it with 10H. If the delay byte was 0, it is replaced by 10H, if it was 10H, it is replaced by 0, such being the action of the XOR command.

The routine is called from Basic by the PUT command. It, like FIELD, can be called from a running program, so that a program which prints to the screen can be slowed in mid-run and speeded up again as needed — useful for instructions. Finally, at 7FF2H, the video delay consists of saving registers, loading BC with the delay bytes, calling the TRS-80 delay subroutine at 0060H, restoring and then jumping to the screen routine at 0458H.

It has been a very useful routine for me, and its usefulness has been enhanced by a short program from A J Harding (Molimerx), which transforms the machine code of a routine into DATA lines of a Basic program. In that way, I can poke it in from any Basic program, so that I do not need to load a separate object code tape.

Furthermore, if I ever need it to be fully re-locatable, I can place the DLY subroutine and the store bytes into low memory between 405C and 407F — that is used only when the TRS-80 is first switched-on. At present, however, the ease with which I can generate object code with Zen makes strict re-locatability unnecessary. □

Execution speed is crucial for realistic mobile displays

G J Marshall describes and compares a variety of techniques for producing mobile displays on a memory-mapped screen. The programs are written specifically for the Pet but the methods involved are appropriate for any microcomputer with a memory-mapped screen.

WHEN STILL pictures are shown successively at a sufficiently high rate, they produce an illusion of continuous movement. All moving-picture systems, including films and television, depend on that subjective effect, which results from several human characteristics, including

the attribute of the persistence of vision. The major problem in achieving realistic mobile displays with a computer is to produce successive static displays sufficiently quickly. Consequently, the execution speed of the system used assumes considerable importance.

The programs presented here are written in Basic. One natural way to increase the speed at which a task is executed is to program in machine code rather than in Basic. While that may be the ultimate solution to the speed problem, we hope to show that by modifying brute-force algorithms for the production of mobile displays, with some care and ingenuity, considerable increases in speed can be obtained still programming in Basic. Also programs in Basic are more easily understood than if they had been written in assembly code.

Figure 1. Flowchart for the full-frame method.

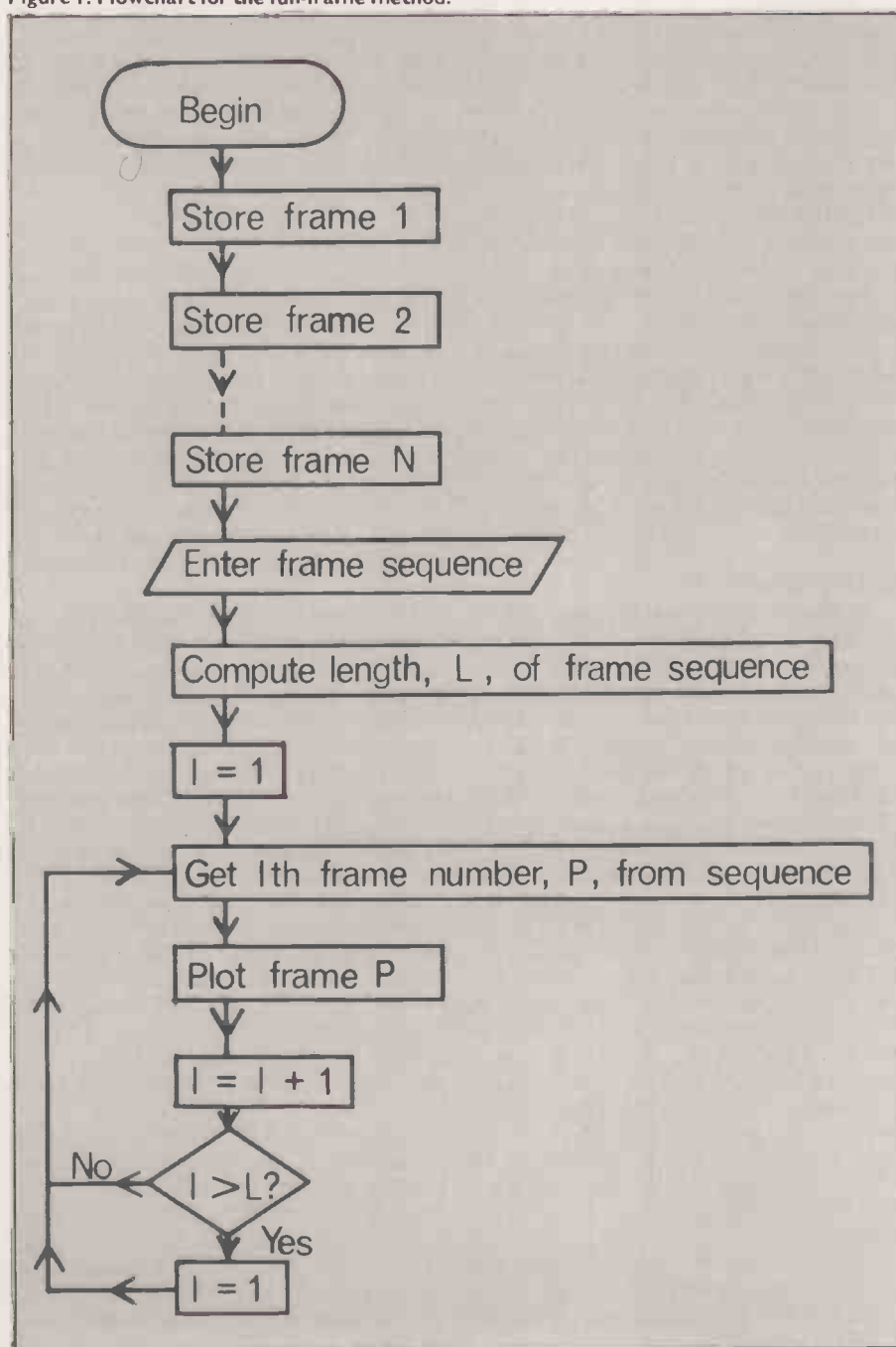

Machine code

In any event, since the actual algorithms are presented, they can be implemented in any suitable way. When the methods described here are implemented in machine code, they usually result in displays which change too quickly, so that delay routines must be introduced.

Ultimately, it should be possible to produce mobile displays of a required quality using the techniques described and implementing them in a suitable language.

The full-frame method of achieving mobile displays is essentially analogous to television or film techniques. First, each frame, or individual picture is stored; then the sequence in which the frames are to be shown, or displays, is entered, and finally, the program plots the pictures successively in the required sequence.

It is more satisfactory if the sequence of frames is plotted repeatedly. An algorithm for that, which stores N frames and repeatedly plays a sequence of them is given in figure 1.

Two implementations

There are two implementations of the algorithm. The first uses POKE instructions to display each frame, and the second uses PRINT instructions. The frames occupy a rectangle of nine rows by seven columns in the centre of the screen. In this case, three frames are stored; they are illustrated in figure 2.

In implementation one, the frames are plotted by using the POKE instruction to place each frame element in the correct place on the screen. Thus, the frames themselves are stored using two-dimensional arrays with nine rows and seven columns to contain the Pet codes used by the POKE instructions.

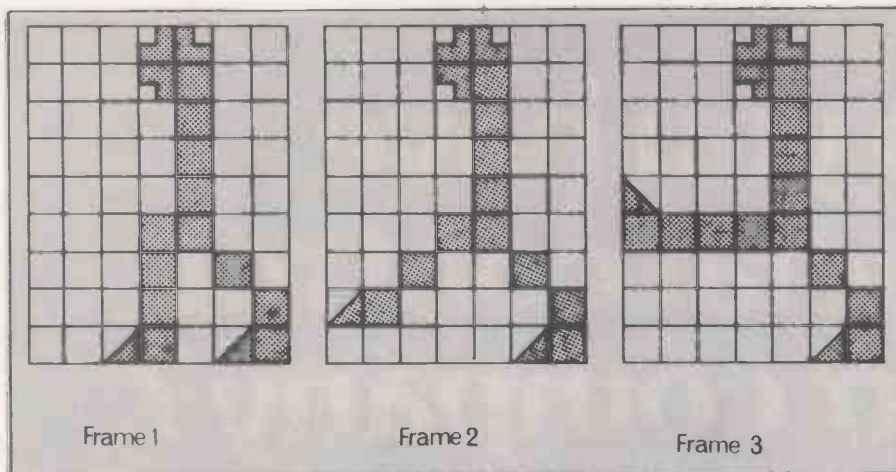

Figure 2. The frames used in the examples.

The respective frames are plotted by subroutines starting at lines 1000, 2000 and 3000. That is more effective than using a single subroutine for plotting since a considerable time would then be spent in transferring the nine-by-seven arrays. The program implementing the full-frame method in this way is given in figure 3. The positioning of the frame on the screen is determined at line 345.

In implementation two, the algorithm can be implemented using PRINT instructions rather than the POKE instruction to implement the frame display. In that instance, each member of a one-dimensional array of string variables contains a complete row of the frame. Again, each frame has its own plotting routine. The program listing is given as figure 4.

Frame position

The positioning of the frames on the screen is controlled by the variables that are initialised in lines 13 and 17. The vertical positioning is determined by Z\$ and the horizontal positioning by Y\$.

In both implementations, the way in which the ON statement at line 350 behaves makes it advisable to precede it by an instruction to test that the frame sequence does not contain a reference to a non-existent frame. A suitable instruction is

```
349 1F (P < 1) OR (P > 3) GOTO diagnostic segment
```

When the full-frame method is used, each new frame is plotted in its entirety. However, if an illusion of continuous motion is to be created, it is essential that successive frames be similar. If they are not, a jerky effect is inevitable. The three frames illustrated in figure 2 are reasonably similar.

Plotting strategy

Consequently, a strategy of plotting only the differences between successive frames can be adopted to advantage. That requires considerably less plotting than the full-frame method and gives a corresponding increase in speed. In fact, for the frames illustrated in figure 2, the average number of places in which any pair differ is approximately seven.

Thus, if differential frame plotting is implemented using POKE instructions, on average only seven POKE instructions are needed to create the next frame, whereas with the full-frame method, $7 \times 9 = 63$ are necessary. Consequently, an increase in speed by a factor of 9 can be expected.

At least one frame must be stored and plotted in its entirety to initiate a sequence of frames plotted differentially. The special algorithm stores frame 1 and always plots it first regardless of the frame sequence. The plotting sequence then

continues with the second frame in the sequence, and follows the sequence faithfully for the remainder of the first pass and for all subsequent passes.

If the difference plotting is done by subroutines, there must be a subroutine for each pair of frames. Thus, when there are N separate frames, there must be N^2 subroutines. However, N of those subroutines are trivial, representing the cases when a frame is paired with itself — that is, when a frame follows itself in the plotting sequence.

A basic program for differential frame plotting of sequences of the frames illustrated in figure 2 may be constructed. The inclusion of a test on the range of the variable SW in the ON statement is more important with differential than with full-frame plotting.

A program for differential frame plotting using implementation two is essentially similar. However, problems of positioning the changes mean that on the whole, it is as effective to print the entire line where a change is necessary as to print a positioning string and a single replacement character.

Table 1 gives the average duration of the frame-plotting subroutines for each of the methods described above when plotting sequences of the frames illustrated in figure 2. The unit of time in the table is a jiffy, or one-sixtieth of a second.

Table 1. Plotting method	Average frame duration
Full frame, implementation one	46
Full frame, implementation two	19
Differential frame, implementation one	5
Differential frame, implementation two	9

The speeds of the two full-frame methods essentially reflect the execution times for, respectively, 63 POKE instructions and nine PRINT instructions. The timings for the differential frame methods are entirely characteristic of the frames being plotted. In implementation one, differential plotting requires only seven POKES on average to update a frame, while full-frame plotting always uses 63. With implementation two, about half the rows in a frame, on average, need to be re-printed to update it.

Figure 3. Basic program for implementation one of the full-frame method.

```
10 DIM A(9,7),B(9,7),C(9,7)
20 FORI=1TO9
30 FORJ=1TO7
40 READ A(I,J)
50 NEXTJ
60 NEXTI
70 DATA160,160,160,126,124,160,160,160,160,160,123,32,160,160
80 DATA160,160,160,160,32,160,160,160,160,160,160,32,160,160
90 DATA160,160,160,160,32,160,160,160,160,160,32,32,160,160
100 DATA160,160,160,32,160,32,160,160,160,160,32,160,160,32
105 DATA160,160,105,32,160,105,32
110 FORI=1TO9
120 FORJ=1TO7
```

(continued on page 99)

Do you have financial control of your company?



When did you last have an up-to-date financial statement?
Do you have effective cash flow management?
Do you get your statements out on time?

The financial controller is the solution to these problems, and is the first of a series of modular programs that form the basis of an integrated business system for the Apple II/Apple III/ITT2020. All programs in the series will run on 5¼" disk drives, 8" disk drives and the 10 megabyte fixed disk. From a starting price of around £3500 inclusive of the micro computer system, the financial controller offers you Cash flow/budget planning. Balance sheet. Profit and loss statements. Sales ledger. Purchase ledger. General ledger. All fully integrated. For up to 1000 accounts.

Available soon. Invoicing stock control – payroll – order processing – mailing – job costing – time recording – database

For the solution to your business problems and a demonstration of the financial controller, contact us or your nearest distributor.

London The Xerox Store London W1 01-629 0694 The Xerox Store London WC1 01-409 3117 Bedfordshire Computopia Leighton Buzzard 376600 Berkshire Lynx Computers Windsor 56322 Cheshire Systems Integration Ltd Altrincham 928 3642/5784 U Microcomputers Warrington 54117 Cornwall Diskwise Callington 3780 Cumbria Furness Computer Services Barrow-in-Furness 24621 Essex Compuskill Romford 751906 Hunt Smees Basildon 21244 Distributed Data Processing Basildon 728484 Herts Local Business Technology Hoddesdon 66157 Leics Leicester Computer Centre Leicester 556268 Merseyside Computer Age Southport 65479 Middlesex Leeway Data Products Feltham 01-898 5757 Norfolk Micro City Services Norwich 25648 Nottinghamshire Keen Computers Nottingham 583254 Oxon MicroMark Henley on Thames 77926 Rocon Oxford 711277 Surrey Ferguson Computer Services West Byfleet 45330 Sussex Datatech Eastbourne 36268 Oval Automation Ltd Worthing 44831 Tyne & Wear P.I.P.S. Computer Services Newcastle Upon Tyne 614939 West Midlands Abovo Systems Coventry 41428 Micrologic Birmingham 6430253 Yorkshire Ram Computer Services Bradford 391166 Scotland Peter Macnaughton E. Kilbride 33562 Wales Cardiff Micro Computers Cardiff 64171 Irish Republic Tomorrows World Dublin 776861 D.B. Micros Limerick 770262

**Systematics
International**



Systematics International Essex House Cherrydown Basildon Essex
Tel: (0268) 284601

• Circle No. 168

(continued from previous page)

Figure 5. Basic program for implementation one of the differential frame method.

```

10 DIM A(9,7)
20 FORI=1TO9
30 FORJ=1TO7
40 READ A(I,J)
50 NEXTJ
60 NEXTI
70 DATA160,160,160,126,124,160,160,160,160,160,123,32,160,160
80 DATA160,160,160,160,32,160,160,160,160,160,160,32,160,160
90 DATA160,160,160,160,32,160,160,160,160,160,32,32,160,160
100 DATA160,160,160,32,160,32,160,160,160,160,32,160,160,32
105 DATA160,160,105,32,160,105,32
280 LP=1
290 I=2
300 PRINT"INPUT PICTURE SEQUENCE"
301 INPUT A#
302 L=LEN(A#)
305 S=32768+8*40+15
306 FORJ=1TO9
307 FORK=1TO7
308 POKE S+K,A(J,K)
309 NEXTK
310 S=S+40
320 NEXTJ
330 P#=MID$(A#,I,1)
340 P=VAL(P#)
350 SW=LP+3*(P-1)
355 S=32728+8*40+15
360 ONSWGOSUB 1000,1500,2000,2500,3000,3500,4000,4500
370 LP=P
380 I=I+1
390 IF I>L THEN I=1
400 GOTO 330
1000 FOR Z=1TO 50:NEXTZ
1020 RETURN
1500 POKE S+1+40*8,160
1510 POKE S+2+40*8,160
1520 POKE S+4+40*8,160
1525 POKE S+3+40*7,160
1530 POKE S+3+40*9,105
1540 POKE S+4+40*9,32
1550 POKE S+4+40*8,32
1560 POKE S+4+40*7,32
1570 RETURN
2000 POKE S+1+40*6,160
2010 POKE S+2+40*6,160
2020 POKE S+3+40*6,160
2030 POKE S+1+40*5,160
2040 POKE S+3+40*9,95
2050 POKE S+4+40*9,32
2060 POKE S+4+40*8,32
2070 POKE S+4+40*7,32
2080 RETURN
2500 POKE S+2+40*8,32
2510 POKE S+1+40*8,105
2520 POKE S+4+40*8,160
2530 POKE S+3+40*9,160
2540 POKE S+4+40*9,160
2550 POKE S+3+40*7,32
2560 POKE S+4+40*7,160
2570 RETURN
3000 POKE S+1+40*6,160
3010 POKE S+2+40*6,160
3020 POKE S+3+40*6,160
3030 POKE S+1+40*5,160
3040 POKE S+1+40*8,95
3050 POKE S+2+40*8,32
3060 POKE S+3+40*7,32
3070 RETURN
3500 POKE S+3+40*9,160
3510 POKE S+4+40*9,160
3520 POKE S+4+40*8,160
3530 POKE S+4+40*7,160
3540 POKE S+1+40*6,32
3550 POKE S+2+40*6,32
3560 POKE S+3+40*6,32
3570 POKE S+1+40*5,105
3580 RETURN
4000 POKE S+1+40*8,160
4010 POKE S+2+40*8,160
4020 POKE S+3+40*7,160
4030 POKE S+1+40*6,32
4040 POKE S+2+40*6,32
4050 POKE S+3+40*6,32
4060 POKE S+1+40*5,105
4070 RETURN
READY.

```

 **apple**® II

©Apple is a trade mark of Apple Computer Inc., Cupertino, CA, USA.

**PLUS
16K RAM**



£485

Send cheque or money order for
£565 (including VAT & Delivery
in the U.K.) to:

Trade Enquiries
Welcome

QUESTEL

Refuge House, 2-4 Henry Street, Bath, BA1 1JT
Telephone: 0225 65379

Please allow 28 days for delivery

3D noughts and crosses in 2K

OWNERS OF 4K RAM microprocessors are probably aware that although it is reasonably straightforward to program arcade-type games, it is much more difficult to produce a game with any intellectual content — unless you write in machine code.

As a recent convert to computing, I was interested in writing a program which would satisfy the following criteria:

- It could play a game and beat me — thus giving some long-term challenge.
- It would not use too much memory.
- It would make its move rapidly.
- It could be written in Basic — I am not yet confident enough to embark on a long machine-code program.
- Its parameters could be adjusted to give players of differing abilities a reasonable game.

After some thought, I produced this program to play 3D noughts and crosses on a four by four by four board. Although the subject matter has been tackled many times before, most commercially-available programs for the game occupy 8K and upwards.

The program meets all the requirements stated, and uses only 2K of RAM. It plays a good game and usually wins with the given parameters, despite always playing second.

The game is played on a four by four by four cube, the object being to achieve a straight line of four noughts or four crosses in any direction. The simplest representation is to show the four horizontal planes of the cube adjacent to each other on the VDU.

Two arrays of 64 elements each are set-up. The array M holds the state of the game — a one represents an empty cell, a two represents an X, and a three a 0. The array N holds the priority values for each cell; the program chooses for its move the cell which has the highest value in this array.

by WN James

Initially, all elements in array M are set to one, indicating empty cells. At the same time, all elements of array N are set to zero, except those elements corresponding to the corners of the cube and the central eight cells of the cube — they are set to 10, lines 50-120.

The cells described lie on seven lines within the cube, whereas all other cells lie on only four lines — obviously the more

Figure 1. Variables used.

A(0) to A(8)	Nine most important line situations.
B(0) to B(8)	Nine priority values added to total priority values in array N.
M(0,0,0) to M(3,3,3)	State of cells array — empty, nought or cross.
N(0,0,0) to N(3,3,3)	Total priority values for cells.
P,R,C	Plane, row, and column co-ordinates for move cell.
PI,RI,CI	Plane, row, and column co-ordinates for cells in line with move cell.
D	Line situation for a particular line — compared to A(N) to find the appropriate priority value B(N) for cells in that line situation.
S	Set equal to the appropriate B(N), and added to the total priority values in the array N.
MC	Move count — game drawn if this reaches 64.
HV	Highest priority value found when all elements of array N are examined.

lines a cell lies on, the more valuable it is.

The player always starts and always has 0. There is no necessity for that, but the program assumes an air of superiority when it wins consistently despite playing second. The move is input in the order plane, row, column: respectively P, R, and C.

Elements in the arrays are in fact numbered from (0,0,0) to (3,3,3). It seems unnatural to have a 0th row or 0th column, hence lines 150 and 190 are included to convert co-ordinates so that all numbers lie between 1 and 4 rather than between 0 and 3.

After the player's move has been input, it is checked for legality — lines 140-170. The lines on which the move cell lies are now identified one by one in subroutine 1000. For example, considering only the first plane — figure 2 — it is clear that all cells lying on the top-left to bottom-right diagonal have $R=C$. Line 1050 tests for such cells. Cells on that diagonal in other planes also have $R=C$ — only the plane number will differ.

There are 13 possible lines on which a cell may lie, and subroutine 1000 tests for them all. If a cell is found to be on a particular line, Q is set to an appropriate number to identify what kind of line, and the program moves to subroutine 4000.

This subroutine does two things; with the flag F initially at zero, subroutine 4000 identifies all the elements in a line and multiplies them together, storing the result in D. Depending upon which line the move cell lies, the temporary variables P1, R1 and C1 take different values — lines 4000-4170 — they are the co-ordinates of all cells lying in a particular line with the move cell. The values of M(P1,R1,C1) for those cells are multiplied to give D — line 4180.

Figure 3 shows the computation which would take place after the player has input his move and in doing so created the line 0*0*. It is clear that any line which gives D a value of nine must contain two 0s, though not necessarily arranged in the order of figure 3.

The value of D thus identifies the situation in a line. On the first pass through subroutine 4000, the value of D for the line being considered is found. The flag F is now set to one, and subroutine 5000 is used to compare D to the nine most important line situations stored in A(0) to A(8). Each of these line situations has a value associated with it, B(0) to B(8) — figure 4.

The first part of subroutine 5000 checks that the game has not been won by the last move. If D equals 16 or 81 there is a row of four crosses or four noughts respectively. If that does not occur, the subroutine searches until the line situation is identified. S is set equal to the appropriate value in array B — line 5050 — and subroutine 4000 now adds S to the priority values in array N — line 4180.

Line 4210 sets the flag F back to zero, and subroutine 1000 is returned to identify any other lines the move cell lies on and repeat the process described.

When all lines on which the move cell lies have been identified and had their priority values N(P1,R1,C1) changed by an appropriate amount, subroutine 3000 determines which of N(P1,R1,C1) has the current highest value, and the program plays its move at this cell.

After making its move, the program

Figure 5. Illustrative game.

For convenience, plays are only considered on the top plane. The player moves first with 0 — the program replies on all even-numbered moves with X. Note that on all its moves the program has a choice of moves, as several cells have N(P1,R1,C1) of the same value. After every move N(P1,R1,C1) is updated as explained in the text, but only for cells in line with the move cell. Examination of each move in conjunction with figure 4 will make the process clear.

Move	New position	N(P1,R1,C1)	Move	New position	N(P1,R1,C1)
Start of game.	10 0 0 10	(4) 1,4,1	0* * X	10 0 0 138
	0 0 0 0		0* * *	20 20 124 24
	0 0 0 0		10 114 10 14
(1) 1,1,1	0* * *	10 0 0 10		X* * *	148 14 14 48
	20 10 10 20	(5) 1,2,2	0* * X	108 10 0 138
	10 10 0 0		00* *	118 226 222 122
	10 0 10 0		10 124 108 14
	20 0 0 20		X* * *	148 24 14 146
(2) 1,1,4	0* * X	10 0 0 38	(6) 1,2,3	0* * X	108 10 14 1138
	10 10 14 14		00X*	20 128 1138 24
	10 14 10 14		10 1124 122 14
	34 0 0 34		X* * *	1148 24 28 146
(3) 1,2,1	0* * X	108 0 0 38	Note that N(P1,R1,C1) is updated even for already-occupied cells: checks could be introduced to avoid that, but the saving in time would probably not be very great.		
	0* * *	118 20 24 24			
	108 14 10 14			
	132 0 0 34			

again uses subroutine 1000 to adjust N(P1,R1,C1) for the cells in line with its move. The game now proceeds until either a win is recorded or the move count reaches 64, in which case all cells have been filled and the game is drawn — line 210.

To summarise: after every move, the program first identifies all cells in line with the move cell in a particular direction; it then determines the situation in that line by multiplying the cell values M(P1,R1,C1) together; finally, it adds a value S to the priority values N(P1,R1,C1) for the cells in the line, S depending upon the line situation determined previously. Figure 5 illustrates the method, with plays take place only in the top plane from the start of a game.

The program has been written deliberately to be machine-independent, and offers several opportunities for changes. Subroutine 2000, which draws the board after every move, could be revised using PEEK and POKE to give a static display.

If line 3050 is deleted, the program will now play the same replies in a new game if the player repeats moves from a previous game. Various strategies can be examined to determine the program's weaknesses.

For an alternative game, reverse the inequality signs in lines 3030 and 3040. The program will now play anti-noughts and crosses, trying to avoid creating lines of four. Remember also to change lines

Figure 2. Top plane of cube.

0,0,0	0,0,1	0,0,2	0,0,3
0,1,0	0,1,1	0,1,2	0,1,3
0,2,0	0,2,1	0,2,2	0,2,3
0,3,0	0,3,1	0,3,2	0,3,3

Figure 3. Computation of D.

Situation in line: 0 * 0 *

Value of M(P1,R1,C1): 3 | 3 | 1

Value of D = 3 x 1 x 3 x 1 = 9

Figure 4. Priority values for line situations.

Line situation	Line value A(N)	Priority value B(N)
0 * * *	3	10
X * * *	2	14
0 0 * *	9	98
X X * *	4	100
0 0 0 *	27	900
X X X *	8	1000
0 X * *	6	-14
0 0 X *	18	-98
X X 0 *	12	-100

Note that the last three values of B(N) are used only at certain times. If a line was already blocked, neither B(7) or B(8) is used — line 5040. If 0 X * * is preceded by 0 * * *, S is set to -10 — line 5030.

5000 and 5020. If lines 140-170 are deleted, and this line substituted:

```
140 gosub 3000: PRINT: PRINT " YOUR
MOVE IS ";PRINT P+1; R+1; C+1
```

the computer will take both sides and play itself.

Experimentation is possible with the program playing both parts with different versions of B(N). If the losing values of B(N) are modified while the winning values are retained, the program becomes self-teaching and will eventually improve.

The values of B(0) TO B(8) are not optimal and can be varied easily to change the program's play — the only changes required are in line 20.

With a few extra lines, values of B(N) can be arranged to vary according to, say, the name of the player. That opens the way to easy wins for yourself by making B(N) for X X X * and 0 0 0 * have low values when you play. It is then clear to any friends watching that the program is a very poor one, as you romp through a number of easy wins.

When they use the program, however, the values given in line 20 are used — it is extremely frustrating to struggle through a game after seeing someone else win with little difficulty.

The program is written as far as possible to be machine-independent, but a few minor changes may be necessary. The Ohio Scientific Superboard II normally has a 72-character line width, so some of the longer lines — such as 4040 — may have to be broken-down into two lines on other machines.

The board, drawn in subroutine 2000, is 25 characters wide, as that is the screen width for the Superboard. Empty cells are denoted by an apostrophe — line 2070 — but any appropriate symbol may be substituted. Line 3050 contains the RND function — that chooses a number between 0 and 1 in Ohio Scientific Basic: that line may have to be re-written.

```

10 REM SET UP BOARD AND INITIALISE VARIABLES
20 DATA 3,10,2,14,9,98,4,100,27,900,8,1000,6,-14,18,-98,12,
-100
30 DIM M(3,3,3), N(3,3,3)
40 D=1: AS="ROWS"
50 FORP=0TO3: FORR=0TO3: FORC=0TO3
60 IF P=R AND P=C THEN 110
70 IF P=C AND P=3-R THEN 110
80 IF P=3-C AND R=C THEN 110
90 IF P=R AND P=3-C THEN 110
100 GO TO 120
110 N(P,R,C)=10
120 M(P,R,C)=1: NEXT C: NEXT R: NEXT P
130 FOR N=0 TO 8: READ A(N), B(N): NEXT N: GOSUB 2000
140 PRINT "INPUT YOUR MOVE":
150 INPUT P,R,C: P=P-1: R=R-1: C=C-1
160 IF P>3 OR R>3 OR C>3 OR P<0 OR R<0 OR C<0 THEN 140
170 IF M(P,R,C)>1 THEN PRINT "CELL OCCUPIED":
PRINT: GO TO 140
180 M(P,R,C)=3: GOSUB 1000: GOSUB 2000: GOSUB 3000
190 PRINT "MY MOVE IS "; P+1; R+1; C+1: MC=MC+2
200 PRINT: M(P,R,C)=2: GOSUB 1000: GOSUB 2000
210 IF MC=64 THEN PRINT "THE GAME IS DRAWN": END
220 GO TO 140
990 REM FIND ON WHICH LINES THE MOVE CELL LIES
1000 FOR Q=1 TO 3: GOSUB 4000: NEXT Q
1020 IF P<>R AND P<>C AND R<>C THEN 1060
1030 IF P=R THEN Q=4: GOSUB 4000
1040 IF P=C THEN Q=5: GOSUB 4000
1050 IF R=C THEN Q=6: GOSUB 4000
1060 IF P<>3-R AND P<>3-C AND R<>3-C THEN 1130
1070 IF P=3-R THEN Q=7: GOSUB 4000
1080 IF P=3-C THEN Q=8: GOSUB 4000
1090 IF R=3-C THEN Q=9: GOSUB 4000
1100 IF P=R AND P=3-C THEN Q=10: GOSUB 4000
1110 IF P=C AND P=3-R THEN Q=11: GOSUB 4000
1120 IF P=3-C AND R=C THEN Q=12: GOSUB 4000
1130 IF P=R AND R=C THEN Q=13: GOSUB 4000
1140 RETURN
1990 REM DRAW BOARD
2000 PRINT SPC(10); "COLUMNS": PRINT
2020 PRINT SPC(4); "1234 1234 1234 1234"
2030 FOR R=0 TO 3: PRINT MID$(AS, R+1, 1); R+1;
2040 FOR P=0 TO 3: FOR C=0 TO 3
2050 ON M(P,R,C) GO TO 2070, 2080
2060 PRINT "0": GO TO 2090
2070 PRINT "'": GO TO 2090
2080 PRINT "X":
2090 NEXT C: PRINT " ": NEXT P: PRINT: NEXT R: PRINT:
PRINT: RETURN
2990 REM FIND CELL WITH HIGHEST PRIORITY VALUE
3000 HV=0: FOR P=0 TO 3: FOR R=0 TO 3: FOR C=0 TO 3
3020 IF M(P,R,C)>1 THEN 3060
3030 IF N(P,R,C)<HV THEN 3060
3040 IF N(P,R,C)>HV THEN HV=N(P,R,C): P1=P: R1=R:
C1=C: GO TO 3060
3050 IF RND(8)>0.5 THEN HV=N(P,R,C): P1=P: R1=R: C1=C
3060 NEXT C: NEXT R: NEXT P: P=P1: R=R1: C=C1: RETURN
3990 REM ADD PRIORITY VALUES TO TOTAL PRIORITY
VALUES
3995 REM FOR CELLS IN LINE WITH MOVE CELL
4000 FOR T=0 TO 3: P1=P: R1=R: C1=C
4020 ON Q GO TO 4050, 4060, 4070
4030 P1=T
4040 ON Q-3 GO TO 4060, 4070, 4100, 4110, 4120, 4130, 4140,
4150, 4160, 4170
4050 P1=T: GO TO 4180
4060 R1=T: GO TO 4180
4070 C1=T: GO TO 4180
4100 P1=P: R1=T: C1=T: GO TO 4180
4110 R1=3-T: GO TO 4180
4120 C1=3-T: GO TO 4180
4130 P1=P: R1=T: C1=3-T: GO TO 4180
4140 R1=T: C1=3-T: GO TO 4180
4150 R1=3-T: C1=T: GO TO 4180
4160 R1=3-T: C1=3-T: GO TO 4180
4170 R1=T: C1=T
4180 IF F=1 THEN N(P1,R1,C1)=N(P1,R1,C1)+S: GO TO 4200
4190 D=D*M(P1,R1,C1)
4200 NEXT T: IF F=0 THEN F=1: GOSUB 5000: GO TO 4000
4210 F=0: RETURN
4990 REM FIND NEW PRIORITY VALUES TO BE ADDED
5000 IF D=16 THEN GOSUB 2000: PRINT: PRINT "I WIN": END
5020 IF D=81 THEN PRINT: PRINT "YOU WIN": END
5030 IF D=6 AND M(P,R,C)=2 THEN S=-10: GO TO 5070
5040 IF D/M(P,R,C)=6 THEN S=0: GO TO 5070
5050 FOR N=0 TO 8: IF D=A(N) THEN S=B(N): GO TO 5070
5060 NEXT N
5070 D=1: RETURN

```

Using Hamming distance as basis for self-correcting code

THE AVERAGE man in the street frequently blames computer for making ludicrous mistakes such as sending an electricity bill for £0.00 or £1,000,000, though they are usually the fault of the person entering the data, or a badly-written program.

The fact still remains that computers do make mistakes — one hopes infrequently — because an occasional bit is misread from a peripheral device or memory. Two established methods of detecting such errors are parity bits and check sums.

Parity checking is achieved by reserving one bit called the parity bit in each word. The parity bit is used solely for checking

correctly. At the time the file was written, an additional piece of information called the check sum was calculated and stored. The check sum is calculated by adding together all of the words in the file.

When the file is subsequently read, the check sum is again calculated and compared with the original stored value. If the two values differ, one or more errors have occurred. If the two values agree, it is assumed that file has been read correctly, but it is remotely possible that compensating errors have occurred.

The two methods detect an error but they do not indicate exactly what is wrong or how to correct it, except by re-reading the entire file. That is particularly time-

distinguish between all possible errors. The second of those requirements is the more difficult to fulfil, for example, with just one mistake each of the following eight bit words

11001100 and 11101110

could both be misread as

11101100

It follows that a code which allows both of the original bit patterns is not capable of self-correction, because the original two patterns are too nearly identical. The usual way of defining how different are two binary words of equal length, is to quote the Hamming distance. That is simply the number of positions in which the two words differ. For example the Hamming difference between the original two words is two.

11001100

11101110

A fuller discussion of Hamming code theory is given in *Information representation and manipulation in a computer* by E S Page and L B Wilson second edition Cambridge University Press, 1978, and

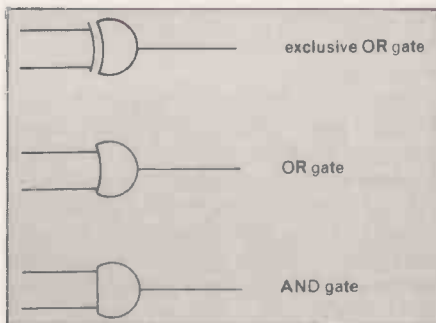

Figure 1.

the data stored in the rest of the word. A computer may be constructed equally well to use either odd or even parity. If one considers an even-parity machine, the parity bit in each word is set to 0 or 1 to make the total number of 1s in that word into an even number.

If any one bit in a word is misread, the total number of 1s in the word will become an odd number. That can be checked, and shows that an error has been detected. Should two errors occur within one word, that will not be detected — though the chance of it happening is remote.

Check sums provide a less precise method of confirming that a whole file or a large block of information has been read

by John and Timothy Lee

consuming with low-speed peripherals such as cassette readers or paper-tape readers, and if the error was generated while writing the original file, all attempts to read it will generate an error.

A system which could both detect and correct errors is highly desirable. That can be done, but for every four bits of data stored, a further four bits of checking information must be stored to permit correction of a single error within those eight bits. That is a significant overhead in the total amount of data stored.

At first sight, storing each four bits twice might appear to provide a simple solution. That would provide for error detection, but since it would not indicate if the error had occurred in the first or second set of four bits, error correction would not be possible. To enable the correction of one bit in an eight-bit word, one must store four bits of data followed by four bits of correction code.

The choice of the correction code is critical since, firstly, it must allow the original data to be generated from the correction bits and secondly, it must

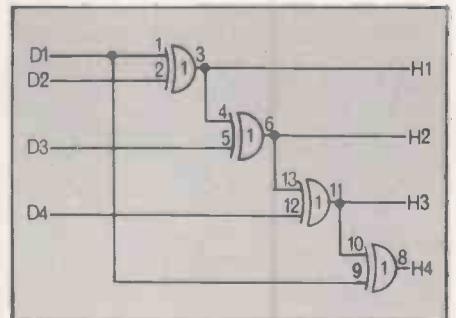

Figure 2.

interesting articles have appeared in *Computer Design*, September 1978, and *Byte*, February 1979.

It is a prerequisite for a self-correcting code which will handle a single error, that the Hamming distance between the two valid coded words must be three or more. In the example, the Hamming distance was only two, hence ambiguity could arise with a single error — making self-correction impossible.

In theory, any code which fulfils the condition of a minimum distance of three could be used for error correction. Most such codes are impractical because it is difficult to re-generate the correct word when an error occurs. Here is a code which is particularly useful because of the simplicity of the error correction algorithm.

A byte, eight bits, of data is split into two four-bit nybbles. The first nybble is stored together with four correction bits, and the second nybble is treated similarly. The following rules define a Hamming

Table 1.

Data Bits				Correction Bits				Hex Equivalent	
bit 1	bit 2	bit 3	bit 4	bit 1	bit 2	bit 3	bit 4	Data	Correction
0	0	0	0	0	0	0	0	0	0
0	0	0	1	0	0	1	1	1	3
0	0	1	0	0	1	1	1	2	7
0	0	1	1	0	1	0	0	3	4
0	1	0	0	1	1	1	1	4	F
0	1	0	1	1	1	0	0	5	C
0	1	1	0	1	0	0	0	6	8
0	1	1	1	1	0	1	1	7	B
1	0	0	0	1	1	1	0	8	E
1	0	0	1	1	1	0	1	9	D
1	0	1	0	1	0	0	1	A	9
1	0	1	1	1	0	1	0	B	A
1	1	0	0	0	0	0	1	C	1
1	1	0	1	0	0	1	0	D	2
1	1	1	0	0	1	1	0	E	6
1	1	1	1	0	1	0	1	F	5

code which will permit single error correction:

- The first correction bit is a parity bit for the first two data bits.
- The second correction bit is a parity bit for the first two data bits.
- The third correction bit is a parity bit for the first three data bits.
- The fourth correction bit is a parity bit for the first three data bits.

In practice, the latter is calculated as the parity of data bits 1, 2, 3, 4 and 1 for reasons which will become obvious. That code depends on even parity. The correction bits for the 16 possible data nybbles are shown in table 1.

Inspection of the eight-bit words produced from the four data bits and the four correction bits shows that any pair of

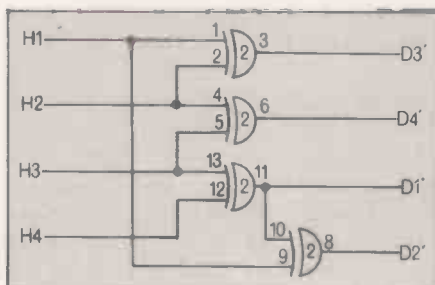

Figure 3.

eight-bit words in the table differ by at least three bits, i.e., the Hamming distance between any pair of words is at least three. That satisfies the first condition for a self-correcting code for one error per word.

The code permits the correction of one error whether it occurs in the data bits or the correction bits, since the data bits can be calculated from the correction bits as follows:

- Correction bit one is the parity for data bits one and two.
- Correction bit two is the parity for data bits one, two and three.

Thus the parity for correction bits one and two is the parity for data bits one and two, and one, two and three, which reduces to data bit three. Similarly

- Data bit four is the parity for correction bits two and three.
- Data bit one is the parity for correction bits three and four.
- Data bit two is the parity for correction bits one, three and four.

Here is a procedure which guarantees the correct assignment of values to the data bits:

1. The data bits and the correction bits are read.
2. The correction bits are initially assumed to have been read correctly. Using the correction bits, the corresponding data bit values are calculated using the rules.
3. The calculated data bit values are compared to the actual values. Three possibilities may occur:

- The two sets of values agree, in which case both the data bits and the correction bits have been read correctly.

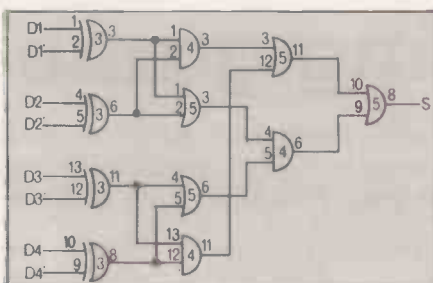

Figure 4.

- The two sets of values differ by one bit, in which case an error has occurred in the data bits. The data value calculated from the correction bits will be correct, and should be used.
- The two sets of values differ by more than one bit, in which case an error has occurred in the correction bits and the values for the data bits are correct.

As an example of the operation of those rules consider the data nybble seven and its associated correction nybble B.

Case a. 7B read correctly as 0111 1011. Step two calculated data nybble as 0111.

Step three the difference between the calculated and observed data nybble is 0 — the byte has been read correctly.

Case b. 7B read as 0110 1011. Data nybble incorrect.

Step two gives calculated data nybble as 0111.

Step three, there is one difference between calculated and observed data nybbles. One error implies that the data nybble has been read incorrectly — use

in this case, the calculated value of 0111. Case c. 7B read as 0111 1001. Hamming nybble incorrect.

Step two gives calculated data nybble as 1010.

Step three, three differences between observed and calculated data nybbles. More than one error implies that the correction nybble is incorrect and the data nybble is correct as read.

Those ideas on a self-correcting code could be implemented relatively easily using low-level system software, and that would have the advantage that on transfer to external media such as a cassette recorder, the existing serial interface components — UART and input/output port — would be used unchanged.

An alternative is to provide a hardware solution — either within the machine or using a parallel output port, though the latter would require an additional UART and associated circuitry. Here are some ideas on a hardware solution. The standard symbols are shown in figure 1. The circuitry to generate correction bits H from data bits D is shown in figure 2. The circuitry to calculate expected data bits D from correction bits H is shown in figure 3. The circuitry to perform the necessary comparisons between the data bits D and the expected data bits D is illustrated by figure 4.

S is set high if there is more than one difference. If S is set, the observed data bits are correct and should be used, otherwise the calculated data bits are used. □

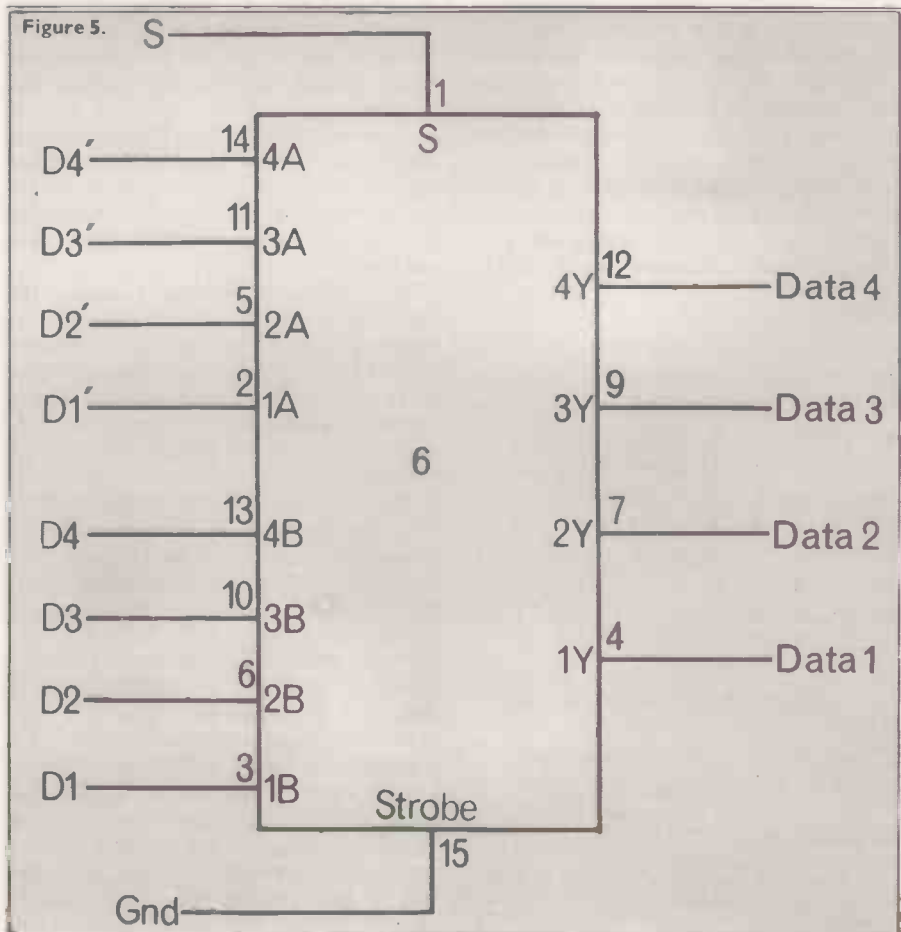

Representing game positions

Mark Josephs explains the various methods with which a game position can be represented in a computer for analysis by move generation and evaluation algorithms. They are of practical value to anyone contemplating writing a program for games such as chess, backgammon and draughts.

LET ME first clarify what I mean by a game position: not only to the specifications for the game board and the positions and types of the pieces, but also to such factors as the colour to move and any special considerations, e.g., a pawn which

ROW NUMBER	8	7	6	5	4	3	2	1
	-4	-2	-3	-5	-6	-3	-2	-4
	-1	-1	-1	-1	-1	-1	-1	-1
	0	0	0	0	0	0	0	0
	0	0	0	0	0	0	0	0
	0	0	0	0	0	0	0	0
	1	1	1	1	1	1	1	1
	4	2	3	5	6	3	2	4
	1	2	3	4	5	6	7	8

COLUMN NUMBER

The initial set-up on a chessboard represented by an 8 x 8 array. To ensure that square (x,y) is on the board, the conditions $x*(9-x) > 0$ and $y*(9-y) > 0$ must be satisfied.

Figure 1.

may be captured *en passant* in a game of chess.

It may be insufficient to represent the board by a straight conversion from squares to storage locations. To prevent pieces being moved from the board, either extra tests can be included in a program or a boundary can also be represented where boundary squares are unoccupiable.

To illustrate that, a chessboard may be represented by an eight-by-eight array — figure 1 — or by a 120-element vector — figure 2. Positive numbers can be used to

Figure 2.

110	7	7	7	7	7	7	7	7	7	7
100	7	7	7	7	7	7	7	7	7	7
90	7	-4	-2	-3	-5	-6	-3	-2	-4	7
80	7	-1	-1	-1	-1	-1	-1	-1	-1	7
70	7	0	0	0	0	0	0	0	0	7
60	7	0	0	0	0	0	0	0	0	7
50	7	0	0	0	0	0	0	0	0	7
40	7	0	0	0	0	0	0	0	0	7
30	7	1	1	1	1	1	1	1	1	7
20	7	4	2	3	5	6	3	2	4	7
10	7	7	7	7	7	7	7	7	7	7
0	7	7	7	7	7	7	7	7	7	7
	+1	+2	+3	+4	+5	+6	+7	+8	+9	+10

Sum gives element number

The initial set-up on a chessboard represented by a 120-element vector. The number "7" indicates a boundary square.

represent pieces of one colour and negative numbers pieces of the other colour, while zero means an empty square. However, that requires that numbers representing boundary squares must change sign after each move or be given a special value.

By implementing that method, using a single vector — figure 3 — both sides move in the same direction. The disadvantages of the method are that a normal move requires altering the contents of four locations instead of two and that the board occupies more storage space.

These descriptions demonstrate methods which hold information about the pieces as the contents of the squares of the board. It necessitates searching through the board array for pieces of the colour to move. An alternative arrangement is to compile a list of pieces in which the location of each piece is stored — figure 4. It creates some problems in determining the contents of the square to which a piece moves — the piece list has to be searched.

By combining these two techniques, it is possible to identify immediately the pieces of the colour to move and to determine whether they may move to a given square. However, a large amount of updating and some additional storage space are required.

As a compromise, in a chess program, the positions of the kings and queens can be kept along with the board array: that is useful because a routine to find attacks on the king or queen is included in most chess programs.

It is now worth considering a design for the representation of a backgammon position. The 24 points can obviously have 24 corresponding elements in an array. The contents of a location would represent the number of pieces on a point, e.g., -4=4 black pieces and +3=3 white pieces.

The bar could best be represented by two elements — to contain the number of pieces on the bar for each colour. Six extra points after each home table might be represented to facilitate bearing off — having the values ± 2 or 0 — and one element could be used to contain the colour to move — +1=white to move and -1 = black to move.

As a challenge to the reader, try writing a program to solve a Solitaire problem. Unlike chess, a tree search to the full depth is possible provided some pruning techniques are used. Do not feel too disconsolate if your micro is not up to the task — my program took more than 30 minutes to solve the centre-hole problem,

time-sharing and in interpreted Basic on an Eclipse minicomputer system.

In conclusion, the method of representing a game position to the computer is of prime importance and deserves careful consideration before writing a program to play a game of strategy.

Figure 3.

210	-1	-1	-1	-1	-1	-1	-1	-1	-1	-1
200	-1	-1	-1	-1	-1	-1	-1	-1	-1	-1
190	-1	4	2	3	5	6	3	2	4	-1
180	-1	1	1	1	1	1	1	1	1	-1
170	-1	0	0	0	0	0	0	0	0	-1
160	-1	0	0	0	0	0	0	0	0	-1
150	-1	0	0	0	0	0	0	0	0	-1
140	-1	0	0	0	0	0	0	0	0	-1
130	-1	-1	-1	-1	-1	-1	-1	-1	-1	-1
120	-1	-1	-1	-1	-1	-1	-1	-1	-1	-1
110	-1	-1	-1	-1	-1	-1	-1	-1	-1	-1
100	-1	-1	-1	-1	-1	-1	-1	-1	-1	-1
90	-1	4	2	3	5	6	3	2	4	-1
80	-1	1	1	1	1	1	1	1	1	-1
70	-1	0	0	0	0	0	0	0	0	-1
60	-1	0	0	0	0	0	0	0	0	-1
50	-1	0	0	0	0	0	0	0	0	-1
40	-1	0	0	0	0	0	0	0	0	-1
30	-1	-1	-1	-1	-1	-1	-1	-1	-1	-1
20	-1	-1	-1	-1	-1	-1	-1	-1	-1	-1
10	-1	-1	-1	-1	-1	-1	-1	-1	-1	-1
0	-1	-1	-1	-1	-1	-1	-1	-1	-1	-1
	+1	+2	+3	+4	+5	+6	+7	+8	+9	+10

Sum gives element number

The initial set-up on a chessboard represented by a 220-element vector. 0 to 110, the board from black's point of view; 100 to 210 for white's.

Figure 4.

	32	82	1
	33	83	2
	34	84	3
PAWNS	35	85	4
	36	86	5
	37	87	6
	38	88	7
	39	89	8
KNIGHTS	23	93	9
	28	98	10
BISHOPS	24	94	11
	27	97	12
ROOKS	22	92	13
	29	99	14
QUEENS	25	95	15
KING	26	96	16

LOCATIONS OF WHITE'S PIECES LOCATIONS OF BLACK'S PIECES

The initial set-up on a chessboard represented by a "piece list".

WEST MIDLANDS

IF YOU WANT A COMPUTER
FOR BUSINESS USE CONSULT
THE EXPERTS!

PAYROLL
STOCK CONTROL
PURCHASE/SALES
STOCK/INVOICING
SPECIALIST PROGRAMS
VISICALC
WORD PROCESSING
MAILING LIST
etc.



 **apple II** SALES AND LEASING

LEASE an Apple II 48K system incl. twin
disk drives, monitor and printer
FROM £11.50 PER WEEK!

MICRO BUSINESS CENTRE

CASTLE BRIDGE HOUSE, LICHFIELD ROAD
WEDNESFIELD; WOLVERHAMPTON
TEL. 0902 725687 FOR SALES & SERVICE

• Circle No. 170

ASSEMBLER PROGRAMMERS

We have career openings for pro-
grammers with experience in micro/
mini assembler/machine language.
We are a large company located in
central London and actively engaged
in developing state of the art operat-
ing systems and communications soft-
ware for mini computers.

These positions will suit young and
high calibre programmers who have an
interest in getting started in real time
and communications software devel-
opment.

PLEASE CALL P. MURRAY ON
01-487 5881 FOR DETAILS.

SHARP MZ-80K

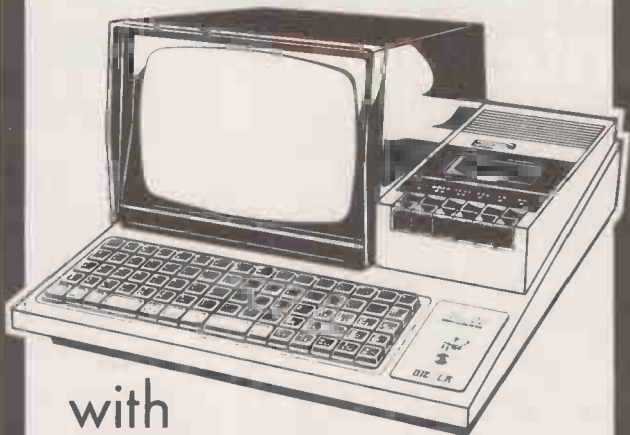

with
48K RAM

£460 + VAT.

*includes delivery within Mainland U.K.

*includes 12 months guarantee.

*tested before despatch

*bona fide official orders welcome

Prices.	Nett	VAT	Total
MZ 80k Computer 48k RAM	460.00	69.00	529.00
MZ 80I/O Interface unit	82.00	12.30	94.30
MZ 80 FD Dual Disk Drive	650.00	97.50	747.50
MZ 80 P3 Printer	430.00	64.50	494.50
CP/M Operating System	200.00	30.00	230.00
PC 1211 Pocket Computer	82.00	12.30	94.30
CE 121 Cassette Interface	12.00	1.80	13.80

ledger and stock control available free with full system purchases.

I enclose cheque/P.O. for: _____

Access: 5224

Barclaycard 4929

Name _____

Address: _____

Post Code _____

Goods required _____

24 Hour - 7 Day ANSAPHONE SERVICE on 051-236 0707 PCI/BI



25 BRUNSWICK STREET,
LIVERPOOL L2 0PJ.
Tel: 051-227 2535/6/7



Mail Orders to:
MICRODIGITAL LIMITED
FREEPOST (No stamp required)
Liverpool L2 2AB.

MICRODIGITAL

• Circle No. 171

Computer Systems and Interfaces

PET
APPLE
HP-85
INTERTEC



Do you need a complete data system?
Anaspec will build you one. We have the instrumentation experience to understand your needs and can design, build and install a data system to suit your requirements.

Do you need interfaces?
We have a NEW series of interfaces for A-D, D-A, BCD, relay closures, stepping motors, X-Y recorders, and others. If these don't suit you, we can make special

interfaces to suit your specification. Anaspec Data Systems Division also provide a service to answer all your questions, to ensure you get the computer you need.

After all, we are one of the leading computer suppliers — and systems builders — to science and engineering.

Contact us now.

ANASPEC

PO Box 25,
Newbury,
Berkshire, England.
Telephone: (0635) 44329.
Telex: 849266.

• Circle No. 172

Acoustic Data Modems

Model 307^o — Originate/Answer
Model 307A — Originate only

Quality with Performance
European Service and Manufacture



TRANSDATA LIMITED

DATA TERMINALS AND COMMUNICATION SYSTEMS
Sales and Marketing Division Telephone: 01 403 5115
Battlebridge House, 87-95 Tooley Street, LONDON, SE1 2RA.

Please send me more information about your Data Terminals and Microcomputers

Name _____
Company _____
Address _____
Tel _____ A3

• Circle No. 173

Inverse-field characters

A USEFUL facility several micros, including Pet and Apple possess, are reverse field characters writes Jerry Hudson of Bedford. That can also be achieved on the Sorcerer by laboriously defining each user-defined key with its inverse field counterpart.

This machine-code routine will define each graphic character with its inverse field equivalent in the user-defined character keys. To obtain a particular graphic character, press graphic and character keys; to obtain its inverse equivalent press graphic-shift-character keys.

To define reverse field alphabet, change 0104 to 08; 0105 to FA. That will place the inverse characters in alphabetical order in the user-defined keys: not QWERTY order, i.e.,

REVERSE FIELD A = GRAPHIC-SHIFT-A
 — — — — — B = — — — — — B

Once defined, the reverse field characters can be accessed from Basic, using ASCII numbers for the user-defined keys and of course directly from the keyboard. The program must be run to define the keys before a Basic program is loaded, as the area of memory it occupies in the Basic control area.

Invert graphics routine number 1.

```
0100H 01 FF 00 Set byte counter
0103H 21 00 FC First graphic address
0106H 11 00 FE First destination address
0109H CD 10 01 Invert first 32 characters
010CH CD 10 01 Invert second 32 characters

010FH C9 Return to monitor
0110H 7E Graphic character to accumulator

0111H 2F Complement accumulator
0112H 12 Accumulator to address in DE

0113H 13
0114H 23
0115H 10 Jump if byte counter 0
0116H F9
0117H C9 Return to mainflow.
```

Invert alphabet routine, number 2.

```
0100 06 1A 00 Load character counter B
0103 21 08 FA Load HL with first ROM character address
0106 DD 21 50 01 Load IX with data address
010A CD 25 01 Call invert single character routine
010D C9 Return to monitor
0125 DD 56 00 Load data
0128 DD 5E 01 Pointer DE
012B D9 Exchange registers
012C 06 08 Set byte counter B'
012E D9 Exchange registers
012F 7E Non-inverted character to accumulator

0130 2F Complement accumulator
0131 12 Accumulator to address in DE
0132 13 Increment DE
0133 23 Increment HL
0134 D9 Exchange registers
0135 10 F7 Jump to 012E if B' 0
0137 D9 Exchange registers
0138 DD 23 Increment IX
013A DD 23 — — — — —
013C 10 7E Jump to 0125 if B 0
013E C9 Return to loop caller
```

```
0150 FE D0 FF 58 FF 48 FE E0 FE
80 FE E8 — DATA
```

For all users of systems based on the Z-80 chip, Z-80 Zodiac offers an opportunity to have programs and ideas published. We pay at least £5 for each contribution used.

```
015D FE F0 FE F8 FE A8 FF 00 FF
08 FF 10 — DATA
0169 FF 68 FF 60 FE B0 FE B8 FE
70 FE 88 — DATA
0176 FE D8 FE 90 FE A0 FF 50 FE
78 FF 40 — DATA
0183 FE 98 FF 38
```

Unsigned numbers

I HOPE that the following routine, which multiplies a 16-bit unsigned number in the DE register pair by an eight-bit unsigned number in the A register, will be of interest writes Dominic Dunlop of Maidenhead, Berkshire.

```
LOC OBJ SOURCE STATEMENT
MULTIPLY_16x8
0000 210000 MULT: LO HL,0 ;CLEAR RESULT
0003 CB3F LOOP: SRL A ;TEST LSB OF ACC
0005 3004 JR NC,NOADD:NO ADD IF ZERO
0007 19 ADD HL,DE ;ADD FACTOR
0008 08 RET C ;OVERFLOW EXIT
0009 1801 JR SHIFT ;
000B C8 NOADD: RET Z ;FINISHED YET?
000C CB23 SHIFT: SLA E ;SHIFT LEFT OF
000E CB12 RL D ;MULTIPLIER
0010 18F1 JR LOOP ;NEXT BIT PLEASE
```

The program shows the power of the Z-80 shift instructions, and may be loaded anywhere in memory — the relative jump instructions make it position-independent. Since the routine terminates as soon as the factor corresponding to the most significant bit in the A register has been added to the product, it executes more quickly, on average, than multiplication routines which examine blindly all bits of the multiplier before terminating.

On exit, the product is in the HL register pair. If the carry flag is clear, the result is valid, but if it is set, overflow occurred, aborting the calculation. The result in this case is invalid.

Varying line length

IN BASIC, screen width is determined by the byte at location 322 decimal (0142 H), writes Ian Bowden of New Barnet, Hertfordshire. That is always set to 64 decimal — 40 H — by a cold-start but, being in RAM, it can be changed to any value you choose between 1 and 255.

That allows you to use more width on a printer, although you cannot see the extra characters appear on the screen. It does not alter the maximum numbers of characters in a Basic statement. It is effective only on the LIST and PRINT functions.

Computamind

I WOULD like to submit a program which is a version of Mastermind, writes Stephen Cronk of Litlington, Hertfordshire. I am fully aware that the program can be condensed, but I designed it to demonstrate string manipulation on the Nascom 2, and so considered it worth the extra length.

The program will run on most machines with Microsoft extended Basic. The only

problems are likely to be CLS, clear screen, and CLEAR, re-set variables, but these are easily overcome.

```
1 D=6
2 DIM$(20),G(4),C(4),B(20),U(20)
6 CLS:
7 PRINT"-----"
10 PRINT"          COMPUTAMIND
20 PRINT"          BY S. CRONK
25 PRINT"-----"
30 PRINT
34 FOR H=1TO2000:NEXT H
40 PRINT"FIGURE OUT A FOUR DIGIT CODE
50 PRINT"USING NUMBERS FROM 1TO6
55 PRINT
70 PRINT" A 'ROM' INDICATES A CORRECT DIGIT"
75 PRINT
80 PRINT" A 'RAM' INDICATES A CORRECT DIGIT
120 PRINT"YOU MAY REQUEST A SUMMARY AT"
130 PRINT"ANYTIME BY TYPING'S'"
135 PRINT
150 PRINT"ARE YOU READY TO START?";
160 INPUT$
170 IF LEFT$(A$,1)="N"THEN PRINT"YOU'RE NO FUN":END
180 FOR J=1TO1000
190 NEXT J
195 CLS
200 FOR J=1TO4
210 R=INT(D*AND(1))
220 C$=C$+MID$(STR$(R),2,1)
230 NEXTJ
240 PRINT"I HAVE CHOSEN MY NUMBER"
250 G=6-I
255 IF G>20 THEN 1140
260 PRINT"GUESS NUMBER"IG$
270 INPUT A$
280 IF LEFT$(A$,1)="S"THEN800
290 IF LEN(A$)>4THEN 1170
294 FORT=1TO2000:NEXTT
295 IFA$=C$THEN910
300 FOR J=1TO4
310 R=VAL(MID$(A$,J,1))
320 IF R<10 RR>6 THEN1170
330 NEXTJ
340 FOR J=1 TO 4
350 G(J)=VAL(MID$(A$,J,1))
360 C(J)=VAL(MID$(C$,J,1))
370 IF C(J)<>G(J)THEN410
380 B=B+1
390 C(J)=0
400 G(J)=0
410 NEXT J
420 FORJ=1TO4
430 IF C(J)=0 THEN 530
440 H=0
450 FORK=1TO4
460 IF C(J)=0THEN510
470 IF C(J)<>G(K)THEN 510
480 H=1
490 G(K)=0
500 C(J)=0
510 NEXTK
520 U=U+H
530 NEXTJ
540 G$(G)=A$
550 B(G)=B
560 U(G)=U
570 PRINT"YOU GOT":B;"ROMS"
575 PRINT"AND " ;U;"RAMS"
576 U=B:B=0
580 PRINT
590 IF G<7 THEN GOTO 250
600 PRINT"THAT IS YOUR LIMIT OF GUESSES"
700 PRINT"*** HARDLUCK***"
710 END
800 REM SUMMARY
805 IF G<1THEN 810
806 PRINT"NO GUESSES YET"
807 GOTO 260
810 CLS
820 PRINT"GUESS NUMBER "
830 PRINT"NUMBER CHOSEN ROMS RAMS
840 PRINT"-----"
850 FOR J=1TO6-I
860 PRINT TAB(3);J;TAB(9);G$(J);TAB(17);
870 PRINTB(J);TAB(25);U(J)
880 NEXT J
890 PRINT"-----"
900 GOTO 260
910 CLS:PRINT"THAT WAS IT
920 PRINT"YOU GOT IT IN ";G;"GUESSES
930 IF G=1 THEN 1050
940 IF G<3 THEN 1030
950 IF G<5 THEN 1010
960 IF G<6 THEN 990
970 PRINT"I HAVE SEEN THE RAVENOUS BUG BLATTER"
975 PRINT"BERST OF TRAL PLAY BETTER"
980 GOTO 1060
990 PRINT"KEEP PRACTISING
1000 GOTO 1060
1010 PRINT"MOVEN-I THINK
1020 GOTO 1060
1030 PRINT"NOT BAD AT ALL"
1040 GOTO 1060
1050 PRINT"I WISH I COULD PLAY LIKE THAT"
1060 PRINT
1070 PRINT"HOW ABOUT ANOTHER GAME?";
1080 GET$
1085 IF Z$="" THEN 1080
1090 IF LEFT$(Z$,1)="N" THEN ENDS
1100 CLS
1110 CLEAR
1120 GOTO 510
1140 CLS:PRINT"THAT IS YOUR LIMIT OF GUESSES"
1150 PRINT"MY NUMBER WAS ";C$
1160 GOTO 1060
1170 PRINT"BLING,BONG
1175 PRINT"ERROR SYNTAX ENTRY
1180 GOTO 260
```

15 good reasons for visiting Cambridge

- | | |
|--------------------------|---------------------|
| 1. Sharp Pocket Computer | 8. Acorn Atom |
| 2. TRS-80 Model I & II | 9. UK-101 |
| 3. Apple II & III | 10. X-Y Plotters |
| 4. CBM (PET) 3000 | 11. Qume |
| 5. North-Star Horizon | 12. Farm Systems |
| 6. Cromemco | 13. Word Processing |
| 7. Hewlett-Packard HP-85 | 14. Computer Books |

With a uniquely comprehensive selection like this — all generally on demonstration and available from stock with full support by our team of computer professionals — you'll have the ideal chance of finding precisely the right system for your application.

Looking for a microcomputer? — then visit us at:

Cambridge Computer Store

1 Emmanuel Street Cambridge CB1 1NE
Telephone: (0223) 65334/68155



• Circle No. 174

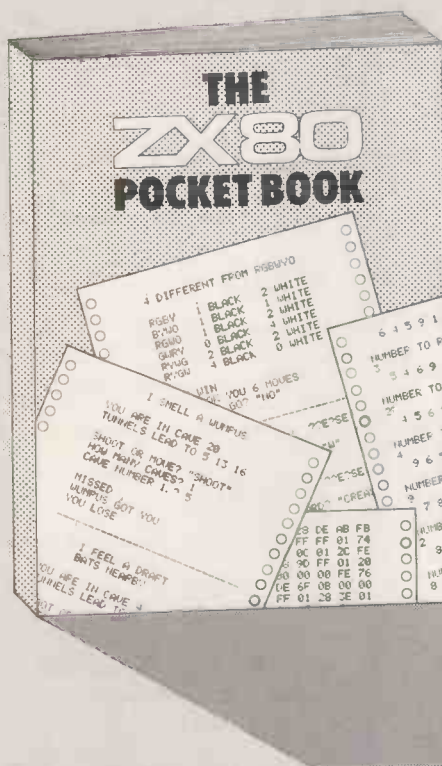

THE ZX80 POCKET BOOK

6 NEW PROGRAMS

- Mastermind
 - Reverse
 - Space-Docking
- Wumpus
 - Hangman
 - Share Valuation
- plus many others

PLUS HINTS AND TIPS ON

- Program Writing
 - Graphics
- Cassette Use
 - Program Efficiency

PLUS REFERENCE SECTIONS ON

- Basic
- ZX80 Op Codes
- Error Codes

92 Pages

£4.95

Including Postage & VAT

Mail Order
only please

PHIPPS ASSOCIATES 3, DOWNS AVENUE, EPSOM, SURREY. KT18 5HQ
or Telephone Epsom (03727) 21215 Quoting your Access Card Ref.



• Circle No. 175

We have had so many requests for advice about software for the little ZX-80 that we have decided to start a club page devoted to the machine. If you have a contribution to make, write to *Practical Computing* marking your letter ZX-80 Line-up. We pay £5 for contributions published.

Direct running

THIS PROGRAM enables programs to be run directly after being loaded writes Ian Logan of Skellingthorpe, Lincolnshire. This feature has been available on other micros for some time but I believe that the enclosed program will be a first for the ZX-80.

I wrote it in response to a question posed by a purchaser of the ZX-80 Companion, second edition in which I wrote the chapter on the monitor.

The technique used is to copy the existing load routine from the monitor, and then add a patch, in machine-code, which closely follows the continue subroutine. The result is that once a program has been loaded, there is no need to press RUN, as the program will start running itself when loading is complete.

```

10 PRINT
20 PRINT
30 PRINT "∇∇DIRECT-RUN∇PROGRAM
  ∇LOADER"
40 PRINT
50 PRINT "IAN∇LOGAN"
60 PRINT
70 PRINT "∇∇LINCOLN,∇OCTOBER
  ∇1980"
80 PRINT
90 PRINT
100 FOR I = 504 TO 597 (copy LOAD routine)
110 POKE 16780 + I, PEEK(I)
120 NEXT I
130 LET I = 17266
140 POKE I, 205 (clear screen)
150 POKE I + 1, 71
160 POKE I + 2, 7
170 POKE I + 3, 253 (set run flag)
180 POKE I + 4, 203
190 POKE I + 5, 1
200 POKE I + 6, 222
210 POKE I + 7, 253 (set statement number
220 POKE I + 8, 54 to zero — 2 bytes)
230 POKE I + 9, 2
240 POKE I + 10, 0
250 POKE I + 11, 253
260 POKE I + 12, 54
270 POKE I + 13, 3
280 POKE I + 14, 0
290 POKE I + 15, 195 (jump to Basic return)
300 POKE I + 16, 71
310 POKE I + 17, 4
320 POKE I + 29, 24 (jump to the above patch)
330 POKE I + 30, 225
340 POKE I + 99, 132 (change a CALL)
350 POKE I + 100, 67
360 PRINT "1.SET TAPE TO START OF
  PAUSE"
370 PRINT
380 PRINT "2.PRESS PLAY"
390 PRINT
400 PRINT "3.PRESS NEWLINE"
410 INPUT Z$ (input Z string)
420 LET K =USR(I + 33)

```

LEN functions

IT IS good news indeed for thousands of ZX-80 owners, writes Eric Deeson of Harborne, Birmingham, that ZX-80 Line-up

is a regular feature; may it grow and grow.

The author of Character manipulation, September 1980, notes that the Sinclair offers no LEN(AS) function. LEN has a number of uses; its absence made the sub-string retrieval program you printed unnecessarily convoluted.

Use the following program to give LEN(AS), called L as is common.

```

10 INPUT AS
20 PRINT AS
30 LET L = 0
40 LET AS = T$(AS)
50 LET L = L + 1
60 IF NOT AS = "" THEN GO TO 40
70 PRINT "ΔHASΔ";L;"Δ
  CHARACTER(S)."

```

The program may be reduced readily to a short and valuable subroutine as follows.

```

1000 LET L = 0
1010 LET AS = T$(AS)
1020 LET L = L + 1
1030 IF NOT AS = "" THEN GO TO 1010
1040 RETURN

```

Re-sequencing programs

THIS PROGRAM is used to re-sequence program lines writes Egidio Debono of Qormi, Malta. Ideally, the program should first be loaded from cassette and then one starts keying one's own program, and, at any instant, RUN 9000 would call the software which asks for the number to be given to the first line.

The second prompt is for the increment required between lines. Lines 9000 to 9140 must be deleted before the re-sequenced program is SAVED on tape. If, however, one wants to re-sequence a program which is already saved, the user's program must first be loaded from tape and, then, the software is entered manually.

It is important that the user's program should have its line numbers less than 9000. Line 9120, in fact, checks whether it has reached line 9000 when it lists the entire program. Care should obviously be taken for any GO TOs and GO SUBs as the target address is not changed. They have to be amended before the program is SAVED.

The software has been written as short as possible. Firstly, so that as little space as possible is used from the RAM, and secondly, so that it would not make it a tedious job entering the program through the keyboard. As a matter of fact, and for curiosity's sake, I have expanded the program to cater for GO TOs and GO SUBs, but there is hardly any space left for entering another program in the ZX-80 configuration.

```

9000 PRINT "STARTING FROM";
9010 INPUTS
9020 PRINTS;"IN STEPS OF"
9030 INPUT T
9040 LET A = 16424

```

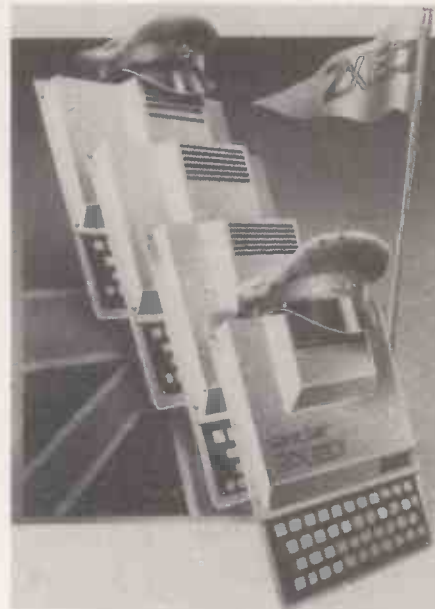

```

9050 POKE A,S/256
9060 POKE A + 1,S
9070 LET S = S + T
9080 LET A = A + 2
9090 IF PEEK(A) = 118 THEN GO TO 9120
9110 LET A = A - 1
9110 GO TO 9080
9120 IF PEEK(A + 1) = 35 AND PEEK(A + 2)
  = 40 THEN LIST
9130 LET A = A + 1
9140 GO TO 9050

```

Long-string handling

UNLIKE ITS larger and more expensive sisters, the ZX-80 has no facility for handling long INPUT strings and it has no file-creating ability other than to store the string variables in a program writes R Urquhart of Romford, Essex. This routine obviates the first problem and solves the second by providing the user with a short program which, together with its string variables, can be stored on tape and recovered when required. By creating separate sets of records for each version of the same program stored, an almost limitless size of file can be built-up on tape.

My particular requirement was to set-up an index of magazine references which I could keep up to date from time to time. In practice, I have kept the records to the length of one print line as a maximum but there is no need for a limit. It will be seen that, as a check after each data entry, the previous entry is printed above the invitation to input the next record. I have provided for 21 records, A to U, per program which means that I can store more than 200 records on a 57p digital tape cassette.

One word of warning: the program must be keyed exactly as shown and any new lines added at the end of the program. You start with the normal RUN command but once all 21 records are cleared, the command GO TO 240 must always be used otherwise the records will be lost.

(continued on next page)

(continued from previous page)

It pays to store the program immediately the records are written and checked by a GO TO 240 so that if a mistake is made subsequently, the programs and variables can be re-loaded. Only a GO TO 240 restores the original listing.

There is no need to insert something at every invitation to type. Hitting NEWLINE will clear the loop to 'DATA END'. It may help, however, to key the appropriate alpha character so that amendments or additions can be inserted. To do that, key line 315 INPUT $\neq \neq \$$ where $\neq \neq$ is the alpha character of the string variable to be inserted. 'GO TO 240' will reveal the amendment or insertion but immediately remove line 315 or it will be over-written next time.

```

10 PRINT "ENTER DATA"
20 INPUT A$
30 LET A = PEEK(16443)
35 IF A = 58 THEN GO TO 200
   [IF A = U THEN 200]
37 LET B = PEEK(16442)
40 IF B = 244 THEN GO TO 65
   [IF B = PRINT THEN 65]
50 POKE 16442,244
   [IF B  $\neq$  PRINT INSERT "PRINT"]
55 CLS
60 GO TO 20
65 POKE 16442,238
   [IF B = PRINT INSERT "INPUT"]
75 POKE 16443,A + 1
   [A,B,C,D ETC]
80 GO TO 10 [LOOP]
200 PRINT "DATA END"
   [A NOW EQUALS U]
235 STOP
240 PRINT A$
275 LET D = PEEK(16582)
280 IF D = 58 THEN GOTO 305
   [IF A = U THEN 305]
285 POKE 16582, D + 1
   [A,B,C,D ETC]
295 GO TO 240
305 POKE 16443,38 [SET BOTH Us
310 POKE 16582,38 back to A]

```

The program also enables the user to create one of those displays popular with retailers. Using the graphics symbols, the display, ZX-80, in 2in. high letters can be printed.

Positron bombers

HERE IS a game which will run on the standard 1K ZX-80 writes Nicholas Meadows of Apperley, Gloucestershire. It uses PEEK and POKE; PEEK to find the start of the display file, and POKE to modify the display file. Since the program uses a large display file, 285 bytes, modifying it with POKE rather than using PRINT statements makes the program run much faster.

As the positron bombs shower from space, you must guide your spaceship across from right to left.

- N Newline moves on step to the left.
- M Newline moves back one step to the right.
- Newline stays stationary.

Your objective is to reach home in the left-hand column. There are a maximum of 15 bombs at any one time, and your task becomes increasingly difficult, because, as you progress further to the

left, all 15 bombs concentrate over your spaceship.

```

10 LET A = 1
20 DIM A(15)
30 LET Z = 299
40 FOR I = 1 TO 15
50 FOR J = 1 TO 19
60 PRINT " ";
70 NEXT J
80 PRINT
90 LET A(I) = RND(19)
100 NEXT I
110 FOR I = 1 TO 15
120 GO SUB 900
130 POKE A + A(I),147
140 NEXT I
150 POKE A + Z,3
160 INPUT I$
170 FOR I = 1 TO 15
180 GO SUB 900
190 POKE A + A(I),0
200 NEXT I
210 POKE A + Z,0
220 IF I$ = "N" THEN LET Z = Z - 1
230 IF Z = 281 THEN GO TO 350
240 IF I$ = "M" THEN LET Z = Z + 1
250 FOR I = 1 TO 15
260 LET A(I) = A(I) + RND(8) = 20
270 IF A(I) > 280 THEN GO TO 300
280 NEXT I
290 GO TO 110
300 LET A(I) = A(I) - 20
310 IF A(I) = Z THEN GO TO 420
320 IF A(I) > 280 THEN GO TO 300
330 LET A(I) = RND(Z - 280)
340 GO TO 280
350 GO SUB 900
360 LET A = A + Z
370 POKE A,173
380 POKE A + 1,180
390 POKE A + 2,178
400 POKE A + 3,170
410 STOP
420 GO SUB 900
430 LET A = A + Z
440 POKE A,181
450 POKE A + 1,180
460 POKE A + 2,188
470 STOP
900 LET A = PEEK(16396) + PEEK(16397) = 256
910 RETURN

```

Battleship game

BATTLESHIPS uses the POKE instruction to produce a display writes R J Goddard of Bath, Avon. The computer randomly generates the position for the three ships, each ship three characters across. The positions of the ships cannot be on the left-hand edge, or upper edge of the screen, thus lines 100 to 155 reject those positions.

Lines 160 to 180 put the three positions of the ships into arrays U, V, W. Lines 190, 250, 310, decide whether the two other characters which compose each ship should be to the left, or above those already put into the arrays.

Lines 370-550 print the grid on the screen; lines 530, 535, decide whether or not a row of spaces or dots will be printed. Alternate rows of spaces and dots appear clearer than dots alone. Line 560 nominates the character to be POKEd, an "X" for a miss.

At line 570 both the X and the Y co-ordinates can be input at once, X first. Numbers less than 10 should have a "0" in front of them, and the two numbers should be separated by a character.

Line 640 converts the two co-ordinates into the co-ordinate for subsequent poking. Lines 630 to 690 check to see if a hit has been scored, in which case the character to be poked is changed from "X" to an inverse space. Line 700 pokes this character on to the screen. "S" is input to stop.

```

10 DIM U(2)
20 DIM V(2)
30 DIM W(2)
40 LET U1 = RND(725)
50 IF U1 < 137 THEN GOTO 40
60 LET V1 = RND(725)
70 IF V1 < 137 THEN GOTO 60
80 LET W1 = RND(725)
90 IF W1 < 137 THEN GOTO 80
100 FOR H = 0 TO 17
110 LET H2 = 137 + H*33
120 LET H3 = H2 + 27
130 IF U1 > H2 - 6 AND U1 < H2 OR U1 > H3
   AND U1 < H3 + 6 THEN GOTO 40
140 IF V1 > H2 - 6 AND V1 < H2 OR V1 > H3
   AND V1 < H3 + 6 THEN GOTO 60
150 IF W1 > H2 - 6 AND W1 < H2 OR W1 > H3
   AND W1 < H3 + 6 THEN GOTO 80
155 NEXT H
160 LET V(2) = V1
170 LET W(2) = W1
180 LET U(2) = U1
190 IF RND(2) = 1 THEN GOTO 230
200 LET U(1) = U(2) - 1
210 LET U(0) = U(2) - 2
220 GOTO 250
230 LET U(1) = U(2) - 33
240 LET U(0) = U(2) - 66
250 IF RND(2) = 1 THEN GOTO 290
260 LET V(1) = V(2) - 1
270 LET V(0) = V(2) - 2
280 GOTO 310
290 LET V(1) = V(2) - 33
300 LET V(0) = V(2) - 66
310 IF RND(2) = 1 THEN GOTO 350
320 LET W(1) = W(2) - 1
330 LET W(0) = W(2) - 2
340 GOTO 370
350 LET W(1) = W(2) - 33
360 LET W(0) = W(2) - 66
370 PRINT " ";
380 FOR A = 0 TO 2
390 FOR B = 1 TO 10
400 PRINT A;
410 NEXT B
420 NEXT A
430 PRINT " ";
440 FOR C = 1 TO 3
450 FOR D = 0 TO 9
460 PRINT D;
470 NEXT D
480 NEXT C
490 FOR F = 0 TO 19
500 IF F < 10 THEN PRINT "0";
510 PRINT F;
520 FOR E = 1 TO 15
530 IF NOT (F/2)*2 = (F*2)/2 THEN PRINT
   "...";
535 IF (F/2)*2 = (F*2)/2 THEN PRINT " ";
540 NEXT E
550 NEXT F
560 LET Y = 61
570 INPUT X$
580 IF X$ = "S" THEN STOP
590 LET X1 = (CODE(X$) - 28)*10 + (CODE
   (TL$(X$)) - 28)
600 FOR G = 1 TO 3
610 LET X$ = TL$(X$)
620 NEXT G
630 LET Y1 = (CODE(X$) - 28)*10 + (CODE
   (TL$(X$)) - 28)
640 LET X = 69 + (Y1*33) + X1
650 FOR I = 0 TO 2
660 IF X = U(I) THEN LET Y = 128
670 IF X = V(I) THEN LET Y = 128
680 IF X = W(I) THEN LET Y = 128
690 NEXT I
700 POKE PEEK(16396) + PEEK(16397)*
   256 + X,Y
710 GOTO 560

```

25 Ways to use **VISICALC Software**

on CBM/PET or Apple

1. A Birmingham sales rep. uses VisiCalc to do his sales reports, sales summaries and expense accounts.
2. A farmer in Wiltshire compares budgeted and actual expenditure, analyzes transactions and solves numerous other business problems.
3. A Louisiana shipyard manager does inventory pricing, cost estimating, and stability and tonnage calculations.
4. A City financial analyst, who computes and prints trust fund reports for his clients, says, "VisiCalc is paying for itself over and over again. An excellent money maker."
5. A California real estate and financial planner automated much of his work with VisiCalc's powerful features. For example, he has created an array of 13 certificates of deposit with varying base amounts, term periods, and interest rates, with associated calculations for required "break-even" terms and interest rates when current date and available money market rates are entered. Penalties for early withdrawal are applied and gain/loss shown if proceeds reinvested. Daily compounding of interest is provided for.
6. A ceramic tile manufacturer has "new applications all the time," including costing model, budget preparation, ceramic empirical formula calculations and financial analysis. Says, "VisiCalc is dynamite."
7. The financial director of a Newcastle company does his budgeting and planning.
8. A professional translator using VisiCalc for cost/profitability comparisons, budgeting and income tax, says VisiCalc is the "best microcomputer application program I've ever seen."
9. A chemical research scientist keeps weekly budget planning, tax records (income and deductions), medical expenses and personal inventory.
10. An Australian manufacturing firm manager's uses include factory production reports, labour costing, calculation of recent price increases, and "a race horse selection program that is yet only moderately successful."
11. A Swiss retail food store manager uses VisiCalc for profit centre calculations, enabling him to know the net profit of every store on a monthly basis with the input of only three reference numbers.
12. A life insurance agent, who already prepares client proposals combining insurance and other investments and quotations on small group plans, says, "I can't wait until I really learn how to use VisiCalc - it's outstanding."
13. A Norwich company secretary appreciates VisiCalc's "ease of use" while doing corporate budgeting, sales forecasts, production forecasts, financial report analysis and ratios, and construction cost analysis.
14. A London management consultant's uses include analysing key financial ratios and balance of business planning and modelling business performance, and management training.
15. An electrical engineer does his business plans, balance sheets, cash flow analysis and sales forecasts. Says he likes VisiCalc's "protection from errors and mistakes."
16. An Oregon medical laboratory director does his workload calculations and space forecasting.
17. A New York finance manager does balance sheet forecasting and keeps a five-year income statement.
18. A Surrey teacher likes the built-in formula calculations when doing statistical research, charts, football statistics, classroom marking and home budget projections.
19. An anesthesiologist calculates gas flows on anesthesia equipment, plus a running record of income tax, pending orders and computer hardware and software expenditures.
20. An executive of a major management consultancy explains how they had used an expensive time-sharing service which tied up a programmer/analyst to create and run the models, so there was always someone between their needs and the final results. "We attempted to duplicate what we had at the service bureau and surprised ourselves that we could do it easily and without specialised programming skills. Now we have evolved far more sophisticated forecasting and modelling tools that go well beyond anything we originally envisaged. These analyses are used by us on behalf of our clients or prospective clients and they help us get more business."
21. A Manchester optician took the hand calculations out of his budgets and sales projections.
22. A senior financial analyst does his balance sheet financial analysis (ratios, rates, yields, etc.) and financial modelling such as profit plans.
23. The president of a New York retail business is using VisiCalc to figure out how he can pay for his personal computer. (He should talk to the guy mentioned in number 4!)
24. The co-owner of a Nuneaton restaurant calculates food costs, bar costs and total operation cost projections.
25. A Massachusetts student is crunching numbers at Harvard Business School with VisiCalc...straight to the head of the class.

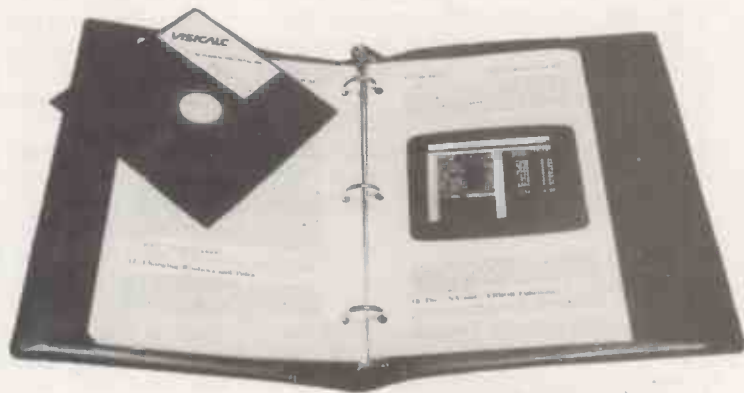

£125+VAT

VisiCalc is the award winning program from Personal Software. It handles mathematical and financial forecasting — and solves just about any problem that can be represented in tabular form. Try it at your nearest PET or Apple dealer or send for your copy direct from:

ACT MICROSOFT

Radclyffe House, 66/68 Hagley Road, Edgbaston,
Birmingham B16 8PF. Tel. 021-455-8585
Telex 339396

PET is the trademark of Commodore Systems. Apple is the trademark of Apple Computers.

- Rush me free details of VisiCalc
 I enclose £125 + VAT for PET/Apple VisiCalc

Name:

Address:

Postcode:

Credit card holders may order by telephoning 021-455 8585

PCI/BI



• Circle No. 176

Screen whitener

THIS PROGRAM designed for a TRS-80 level II, when called, whitens the entire screen writes N Brickell of Plymouth. That provides a quick and useful display function and dispenses with other slow methods, such as "SET" and "POKE".

```
10 REM * SCREEN FILL ROUTINE *
20 FORN = 16512 TO 16523
30 READA:POKEN,A:NEXT
40 DATA 33,0,48,17,0,60,1,0,4,237,176,201
50 NEW
```

User Call:

```
POKE 16526, 128: POKE 16527,64:X=USR(0)
```

The machine-code program resides in the level II Basic RAM area, thus using no RAM.

```
10 REM *** DECIMAL TO HEXADECIMAL
  CONVERTER ***
20 CLS: INPUT "ENTER DECIMAL
  NUMBER (0-65535)";A
30 H1 = FIX(A/4096):A$ = STR$(H1):X1$ =
  A$:IFH1>9 GOSUB 100 ELSE 40
32 X1$ = B$
40 B = (A-H1*4096):H2 = FIX(B/256):A$ =
  STR$(H2):X2$ = A$
42 IFH2>9 GOSUB100ELSE50
44 X2$ = B$
50 C = (B-H2*256):H3 = FIX(C/16):A$ =
  STR$(H3):X3$ = A$
52 IFH3>9 GOSUB100ELSE60
54 X4$ = B$
60 D = (C-H3*16):H4 = D:A$ = STR$(H4):
  X4$ = A$
62 IFH4>9 GOSUB100ELSE70
64 X4$ = B$
70 CLS:PRINT "DECIMAL";A;" = HEX"
  X1$ "X2$ "X3$ "X4$
80 R$ = INKEY$:IFR$ = "" THEN80ELSE20
100 IFVAL(A$) = 10 THENB$ = "A"
110 IFVAL(A$) = 11 THENB$ = "B"
120 IFVAL(A$) = 12 THENB$ = "C"
130 IFVAL(A$) = 13 THENB$ = "D"
140 IFVAL(A$) = 14 THENB$ = "E"
150 IFVAL(A$) = 15 THENB$ = "F"
160 RETURN
```

The program converts a decimal number — 0 to 65,535 — into its Hexadecimal counterpart. It was designed for a TRS-80 level II but should run on most microcomputers.

Enter the decimal number and in about a second, the Hexadecimal number should be returned. Once the answer is back, pressing any key will allow a new decimal entry.

Generating music

THIS ARTICLE — by Tony Lacy of Willenhall, West Midlands — serves two purposes, firstly, it presents a useful module to incorporate programs, secondly, it is a demonstration of an alternative method of embedding machine-code subroutines in main programs written in Basic.

I needed a self-contained routine which I could incorporate into programs to generate sound effects using an amplifier plugged into the cassette jack he writes.

The technique uses the concept of hiding machine-code subroutines in single-dimension integer arrays. TRS-80 Basic stores that kind of variable as contiguous pairs of bytes, each byte pair representing an element.

We can assign values to those byte pairs such that, if the processor knows where to start execution, it will run just like any

TANDY FORUM is devoted to the Tandy TRS-80. Sometimes we will use it to pass on news about the TRS-80 but, above all, it is for users, and would-be users, of the well-established model I and now the new model II. With your tips, queries, moans and comments, this page can become a market-place for TRS-80 information.

other average machine-code program.

A program using the method lists normally and, what is more, values can be passed to and from the subroutine by operating directly on the array elements. In fact, the structure of the subroutine could be modified from the calling program. No system loads or reserved memory areas are necessary.

Line 20 is necessary only in disc Basic; it executes a disable interrupt if that is not included, the tone output is interrupted every few milliseconds, making it sound ragged.

Line 40 is the decimal equivalent of listing 2. Here is an easy way to generate decimal values from a Hex listing:

1. Load the Hex code in using T-BUG or system, making a note of the start and end addresses.

2. Basic, write this one-line program and run it.

```
10 FOR X = START TO END:PRINTPEEK
  (X);NEXT
```

The required decimal values will be printed. Line 70 is needed because of the way that integer values are stored in MSB LSB form.

Computers represent negative integer by allocating values in the range 7FFFH and FFFFH. To enter such values, we need to make our number negative — for a more thorough explanation, see TRS-80 Assembly Language Programming by William Bardon and published by Radio Shack. Line 90 allocates the value to the array element.

Put your program in the place of line 110, L is the note duration, T is the frequency, as that line stands, it will generate random notes of random duration.

If you examine the assembly-code listing, you will see that the first operation does not seem to make sense. That is rectified in line 150, the element I%(1) is given a value derived from L and T before the subroutine is called. That demonstrates the ease with which values can be transferred into and out of subroutines using this method.

Line 160 contains the dreaded VARPTR feature which is used to tell us where the array is in memory. That information is needed for the next process — the call.

USR calls are analogous to GOSUB, except that the subroutine being called is written in machine-code. The computer has to be told where to go and that is the main use of the VARPTR feature. It is done in disc Basic using the DEFUSR function — line 180 — in level II Basic however, values have to be POKED as in lines 200 to 220.

Line 230 is the call; the return from the call by a simple machine-code RET instruction and line 240 completes the loop.

Finally, if you do not find the short explanation very helpful, use the program as it is and experiment with line 110.

Listing 1. Complete music generator program

```
10 'LINE 20 ONLY NEEDED IN DISK
  BASIC
20 'CMD'T
30 DIMI%(11)
40 DATA0,33,0,0,62,1,211,255,69,16,254,
  62,2,211,255,69,16,254,37,200,24,238
50 FORI1 = 0 TO 10
60 READB:READA
70 C = 256*A + B
80 IFC>32768 THENC = C - 65536
90 I%(I1) = C
100 NEXT
110 L = RND(200) + 55:T = RND(200) + 55
120 IFL>255 OR L<1 OR T>255 OR T<1 THEN
  110
130 A = 256*L + T
140 IFA>= 32768 THENA = A - 65536
150 I%(I1) = A
160 V = VARPTR(I%(0)) + 1
170 'USE LINE 180 IN DISK BASIC AND
  DELETE 200-220
180 'DEFUSR = V
190 'LINES 200-220 ARE FOR L2 BASIC
  ONLY
200 MSB = INT(V/256)
210 LSB = V - 256*MSB
220 POKE16526,LSB:POKE16527,MSB
230 X = USR(A)
240 GOTO110
```

'IS TRS-80 shorthand for REM

Listing 2. Assembler listing for USR subroutine.

```
7000          00100          ORG 7000H
;CODE IS RELOCATABLE
7000 21000 00110 FIRST LD HL,0
;TWO BYTES LOADED WHEN
00115
;I% (1) ALLOCATED
7003 3E01 00120 START LD A,1
;PORT LOW
7005 D3FF 00130          OUT (255),A
;OUTPUT IT
7007 45 00140          LD B,L
;GET DELAY VALUE FOR FREQUENCY
7008 10FE 00150 LOOP1 DJNZ LOOP1
;TIME DELAY
%00A 3E02 00160          LD A,2
;PORT HIGH
700C D3FF 00170          OUT (255),A
;OUTPUT IT
700E 45 00180          LD B,L
;GET DELAY AGAIN
700F 10FE 00190 LOOP2 DJNZ LOOP2
;TIME DELAY
7011 25 00200          DEC H
;NOTE DURATION TIMER
7012 C8 00210          RET Z
;BACK TO BASIC IF TIME UP
7013 18EE 00220          JR START
;IF NOT GO ROUND AGAIN
7000 00230          END FIRST
;ENTRY POINT DEFINED
00000 TOTAL ERRORS

FIRST 7000 00110 00230
LOOP1 7008 00150 00150
LOOP2 700F 00190 00190
START 7003 00120 00220
```

Comart Approved
Cromemco Dealers

Belfast
O & M Systems
95 Dublin Road
Contact: Richard Owens

Birmingham
Byteshop Computerland Ltd
94/96 Hurst St, B5 4TD
Contact: Jim Attfield
Tel: 021 622 7149
Telex: 336186 BYTE G.

Cambridge
Cambridge Computer Stores
1 Emmanuel St, CB1 1NE
Contact: Claude Cowan
Tel: 0223 68155

Cornwall
Benchmark Computer
Systems Ltd
Tremena Manor
Tremena Road
St Austell, PL25 5GG
Contact: John Fisher
Tel: 0726 610000

Dublin
Lendac Data Systems Ltd
8 Dawson St
Contact: Danny McNally
Tel: 0001 372052

Glasgow
Byteshop Computerland Ltd
Magnet House
61 Waterloo St, G2 7BP
Contact: Gordon Coventry
Tel: 041 221 7409
Telex: 779263 BYTE GW G

Leeds
Holdene Ltd
Manchester Unity House
11/12 Rampart Road
Woodhouse St
Contact: Jim Jackson
Tel: 0532 459459
Telex: 556319 HOLDEN G

London
Byteshop Computerland Ltd
48 Tottenham Court Road,
W1B 5TD
Contact: John Braga
Tel: 01 636 0647

Digitus
9 Macklin Street
Covent Garden WC2
Contact: Alan Wood
Tel: 01 405 6761

Manchester
Byteshop Computerland Ltd
11 Gateway House
Piccadilly Station Approach
Contact: Peter King
Tel: 061 236 4737
Telex: 666186 COMMAN G

NSC Computers
29 Hanging Ditch
Contact: Adam Wiseberg
Tel: 061 832 2269

Newbury
Newbear Computing Store
40 Bartholomew St
Contact: Tim Moore
Tel: 0635 30505
Telex: 848507 HJOLPN

Nottingham
Byteshop Computerland Ltd
92A Upper Parliament St,
NG1 6LF
Contact: David Clarke
Tel: 0602 40576
Telex: 377389 BYTENOG

Sheffield
Hallam Computer Systems
451 Eccleshall Road, S11 9PN
Contact: Stuart Pulford
Tel: 0742 663125

Southampton
Xitan Systems
23 Cumberland Place,
SO1 2BB
Contact: Geoff Lynch
Tel: 0703 38740

Sudbury
Eurotec Consultants
Holbrook Hall
Little Waidingford
Contact: Dr Kilmowicz
Tel: 0206 262319
Telex: 987248

Warwick
Business & Leisure
Microcomputers
16 The Square
Kenilworth
Contact: David Searle
Tel: 0926 512127

**Comart Microcomputer
dealers are located
strategically throughout the
country to give support,
guidance and assistance. In
the event of difficulty, contact
Comart direct.**

 **Cromemco**



Flexibility + Versatility

System Flexibility

Cromemco give you the high performance, reliable computer power you need now, with the in-built capability for future expansion and adaption as demands and requirements change.

The choice is wide. Cromemco's S-100 bus construction provides for expandable memory capability and the widest choice and future options in peripheral support.

Now there is the exciting range of Cromemco High Resolution Colour Graphics Systems.

Applicational Versatility

Cromemco's CDOS Operating System supports proven, well documented Software for Business, Industry, Science, Research and Education; COBOL, RPG II, Macro Assembler, 16K and 32 BASIC, FORTRAN IV, LISP, RATFOR, Word Processing and Data Base, are all included in the range.

Now, there is the new CDOS compatible, Cromix Multi-user Multitasking Operating System which opens up new avenues in application and performance for Cromemco System Users.

The U.K. Leaders in Microcomputer Development, Application and Support.

comart

PO Box 2, St Neots, HUNTINGDON, Cambs
Tel: (0480) 215005 Telex: 32514 Comart G.

• Circle No. 177

ALTOS



The true multi user computer system

The ALTOS ACS 8000 range of business/scientific micro computers creates a new standard in quality and reliability in high technology micro computers.

Hard Disk/Multi User Systems

The Winchester hard disk/multi user systems are now available supporting up to 4 simultaneous users and providing a maximum of 58 Megabytes of hard disk data storage.

The systems are truly flexible and allow expansion of the ALTOS floppy disk system to keep pace with the users requirements.

Still single board, features include

- a high speed I/O section with up to six serial ports and one 8 bit Parallel port
- up to 208K of on board R.A.M.
- High speed (4 MHz.) D.M.A. control as standard.

Yes, mini power and at micro cost too.

Hard Disk Security Back-up

The 17.5 Megabyte funnel tape unit permits selective dumping from the Winchester at a rate of 1 Megabyte per minute.

Built-in Reliability

The ACS 8000 range are true single board micro computers making them extremely reliable and maintainable. All electronics are socketed for quick replacement. Complete diagnostic utility software for drives and memory is provided.

The board and Shugart floppy disk drives are easily accessible and can be removed in less than ten minutes.

Quality Software

Unlimited versatility. The ACS 8000 range support the widely accepted CP/M and MP/M operating systems plus basic (Microsoft and CBasic), Cobol, Pascal, and Fortran IV. All available now.

Logitek in conjunction with its own microsoftware house, Interface Software Ltd. of Camberley are able to supply a wide range of proven 'off-the-shelf' business software including general accounting, word processing, stock control, mailing list etc.

There are already over 1000 micro computer installations using this software. A track record which we consider speaks for itself. Why 're-invent the wheel' when there is standard software of this quality available now?

Communication Software

Two new custom software packages are now available for the Altos Computer System operating with CP/M to enable it to communicate with remote machines over ordinary telephone lines. ASYNC is an asynchronous package that operates with almost any remote machine. SYNCH is a synchronous package for use with the IBM 3780 protocols.

Custom Graphics & Scientific Software

A full graphics and scientific package is now available for use for the Altos with FPP.

GRAFLIB is a custom Altos software package containing a complete range of FORTRAN callable graphics subroutines. It is designed with DRE-RC 512 board, or a Tektronix 4000 series graphics terminal. Several multi-colour X-Y plotters are supported allowing hard copy in addition to screen graphics.

After Sales Support

Logitek are supported by DDT Maintenance Ltd. who provide a nationwide field maintenance service for Altos products and offer the option of maintenance contracts.

Availability

Logitek carry deep shelf stocks of Altos hardware and compatible peripherals.



LOGITEK

LOGITEK, E.I.C. Electronics Ltd.

All enquiries to
8-10 Fazakerley St., Chorley,
Lancs. Tel: 02572 67615/70206

also at
30 Kelvin Ave.,
Hillington Industrial Estate,
Glasgow G52 4LH

Logitek are now the exclusive distributors of
Altos Computer Products for the U.K. and Eire

● Circle No. 178

● Circle No. 179 ►

We are now entering our fourth financial year of dealing solely in the personal computer market — in fact, we started it! Over this period, Personal Computers Limited have formed a group of graduate specialists who will help you in the fields of word processing, financial planning, statistics, economic modelling, forecasting, accounting systems, foreign exchange, banking and oil exploration.

We also do rather well with computer graphics and highly recommend the graphics tablets and our plotter for Apple.

We can also offer two excellent items of software — Format 40 and Visicalc — at a combined price of ONLY £189, and the Super Sound Generator for only £90! (excl. V.A.T.)



8" Disk Drive (above left)

Our 8" disks are still as popular as ever — 2 drives give you 1.2MB with all the reliable security of Shugart Technology. Easily interfaced to Apple, uses the same D.O.S.

A.I.O. Serial and Parallel Card (above centre)

Three hand-shake lines (R.T.S., C.T.S. and D.C.D.). Firmware for serial interfaces on-board, software for parallel printer available, 2 bi-directional 8 bit parallel ports, plus 4 additional interrupt and hand-shaking lines.

Light Pen (above right)

A much sought after product which we introduced to the U.K.

80 Character Card (below left)

... opens up the real commercial world for all Apple owners.

Paper Tiger (Below centre)

132 character line, plus graphics, 8 character sizes, ordinary paper, multiple copy, upper and lower case 96 character, parallel/serial, form control.

Centronics 730 (Below right)

A substantial, robust printer from a major manufacturer. 3 way paper handling system, 100 character per second. Special low-cost including interface. 96 characters.



Items pictured

Sharp MZ — 80K

A new generation of personal computer, self contained, versatile and starting at only £570 (excl. VAT). Explore the Zilog Z80 now the easy way. Disks and printer available shortly.

Numeric Keypad

... with 8 function keys is a must in all financial applications.

TCM 100 & TCM 200

... both now have graphics as well as their own power supply, essential with this type of printer.

Qume Sprint 5

The quality word processing printer. Clean, clear executive reports the way you want them. Can print up to 5760 points per square inch — or even print in 2 colours.

This is what we do..

and we do it rather well!



Personal Computers Limited
194-200 Bishopsgate, London EC2M 4NR. Tel. 01 626 8121

For further information, please complete this coupon and post to:
Personal Computers Limited, 194-200 Bishopsgate, London EC2M 4NR. PC1/81

NAME _____ ADDRESS _____

*** Now here, details for APPLE III**

RAIR BLACK BOX
MICROCOMPUTER

POWER
LOAD
RESET

RAIR MICROCOMPUTER
BLACK BOX

*Discover the secrets of
the RAIR Black Box*

(continued from previous page)

```

10 0000 ; Interrupt routine to connect BASIC garbage collection
20 0000 ;*****
30 0000 ;
40 0000 ;
50 0000 START=$0230
60 0230 *=START
70 0230 ;
80 0230 48 START PHA
90 0231 8A TXA
100 0232 48 PHA
110 0233 BA TSX
120 0234 BD0501 LDA $0105,X ;Test where NMI came from.
130 0237 C9B1 CMP $B1 ;High byte.
140 0239 F008 BEQ NEXT1
150 023B C9B2 CMP $B2
160 023D F021 BEQ NEXT2
170 023F 68 GOBACK PLA ;Return when required.
180 0240 AA TAX
190 0241 68 PLA
200 0242 40 RTI
210 0243 BD0401 NEXT1 LDA $0104,X ;Low byte.
220 0246 C9BC CMP $BC
230 0248 F006 BEQ FOUND
240 024A C9CC CMP $CC
250 024C D0F1 BNE GOBACK
260 024E F025 BEQ NEXT3
270 0250 A9C6 FOUND LDA $C6 ;Change return address.
280 0252 9D0401 STA $0104,X
290 0255 68 PLA
300 0256 AA TAX
310 0257 68 PLA
320 0258 28 PLP
330 0259 200BB2 JSR $B20B ;New section.
340 025C E6A0 INC $A0
350 025E 08 PHP
360 025F 40 RTI
370 0260 BD0401 NEXT2 LDA $0104,X ;Test low byte.
380 0263 C91E CMP $1E
390 0265 D0D8 BNE GOBACK
400 0267 A921 LDA $21 ;New low byte address.
410 0269 9D0401 STA $0104,X
420 026C 68 PLA
430 026D AA TAX
440 026E 68 PLA
450 026F 28 PLP
460 0270 2902 AND $02 ;New section.
470 0272 18 CLC
480 0273 08 PHP
490 0274 40 RTI
500 0275 68 NEXT3 PLA
510 0276 AA TAX
520 0277 68 PLA
530 0278 28 PLP
540 0279 F002 BEQ NEWADD ;New - Test zero.
550 027B 08 PHP
560 027C 40 RTI
570 027D 08 NEWADD PHP
580 027E 48 PHA
590 027F 9A TXA
600 0280 48 PHA
610 0281 BA TSX
620 0282 A9B9 LDA $B9 ;New address.
630 0284 9D0401 STA $0104,X
640 0287 68 PLA
650 0288 AA TAX
660 0289 68 PLA
670 028A 40 RTI
680 028B ;
690 028B ;
700 028B ;Section to setup NMI vector.
710 028B ;-----
720 028B ;
730 028B HIGHBT=START/256*256
740 028B ;
750 028B 209702 JSR SETUP ;Entry for COLD START BASIC.
760 028E 4C11BD JMP $BD11
770 0291 209702 JSR SETUP ;Entry for WARM START BASIC.
780 0294 4C74A2 JMP $A274
790 0297 A930 SETUP LDA $START-HIGHBT ;Forms low byte.
800 0299 8D2302 STA $0223
810 029C A902 LDA $START/256
820 029E 8D2402 STA $0224
830 02A1 A90C LDA $0C ;Clear screen code.
840 02A3 2057FA JSR $FA57 ;To screen print.
850 02A6 60 RTS

```

High resolution

HAVING no previous experience in computing, apart from a very rewarding three-year relationship with a TI-59 programmable calculator, I at last decided on an Apple II plus, Auto-start ROM, 48K, six months ago writes Christian Borup of København, Denmark.

My dream, and partly my reason for the choice, was to use both high-resolution screens in conjunction with extensive programs to compare high-resolution plotted horoscopes — I work in the field of astrology.

I was stunned by the awkward placement of the two 8K high-resolution screens in the middle of the memory-range, dividing the usable RAM-area into two blocks of 6K and 24K each — no DOS. I was confident that a big program could be loaded above the HGR2 area in memory. The dream turned to a nightmare. The LOMEM-command did not permit it, although the Applesoft manual shyly mentions LOMEM in connection in this context.

So I sat sadly, with an expensive 48K machine, no knowledge of machine-code, a 18K program which used both high-resolution screens, but absurdly, nowhere to put it.

My first attempt to solve the problem consisted of typing 100 lines of REM-statements, checking with the monitor to be sure that the program proper started at location 24576. I found that after a HGR-statement, Applesoft ignored my laborious attempts, leaving me with a 6K

This section is open to the Apple user. In every issue we hope to print ideas, hints and comments about the Apple and its suppliers. They must come from you, so write and tell us what you know.

program consisting of REM-statements.

Deeply distressed, I telephoned the firm where I had bought the machine. Not having encountered the problem before, the software consultant advised to type in 22K of REM-statements, and hope for the best. That was exactly what I had so painstakingly done with a striking lack of success.

After two days of trial and error, trying to discover what happened in the different locations in the zero-page, a practical and wonderfully-simple solution dawned on me.

Locations 103 and 104 — 67 and 68 in Hex — contained the pointer to the address where the program started. By POKEing a start address into those two locations, a program could be LOADED into any part of the RAM-area.

To load a program above HGR, POKE 103,0 : POKE 104,64. To load a program above HGR2, POKE 103,0 : POKE 104,96, before loading your program.

When manually entering a new program, type two lines, SAVE on tape, POKE the chosen start-addresses into locations 103 and 104, and LOAD again, then no harm will come to you or your program, and you can continue typing. POKEing before you start typing in a new program causes your program to crash when run, but creating a wonderful

tattered effect on the GR-screen.

The lower unused 6K can, of course, be used for big machine-code subroutines or shape-table definitions.

Cross-reference program

Edward McGeough of Aberdeen offers a program which produces a listing of a program together with a cross-reference of the variables used.

Having entered the program and saved on disc, he writes, the program is run once to create an Execute file named 'EXEC-XREF'. The execute file is used thus:

- Load the program for which a listing is required: LOAD YOURPROGRAM.
- Execute the Exec file: EXEC EXEC-XREF
- Lines 60000-60071 are appended to the program loaded, run from 60000 to store all variable names and the line numbers in which they are used, then sorted and a listing of the program with cross-references is produced on the printer.

The listing enclosed should be modified in lines 60009 and 60063 to make the highest line number referenced to 59999 — from 60071.

The printer is assumed to be in slot two with width 76 — line 60063 — set W to 40 for screen output, and remove reference to slot two.

```

0 REM 'XREF'
10 REM RUNNING THIS PROGRAM WILL SAVE
20 REM THE LINES 60000-60071 IN AN
30 REM EXEC FILE 'EXEC XREF' WHICH MAY
40 REM BE EXECUTED DIRECTLY ON A PROGRAM
50 REM IN MEMORY TO GIVE A CROSS-REF
60 REM LIST OF THE PROGRAMS VARIABLES
70 REM
90 N$ = "EXEC-XREF"
100 D$ = CHR$(4)
110 PRINT D$;"OPEN "N$;"
120 PRINT D$;"DELETE "N$;"
130 PRINT D$;"OPEN "N$;"
140 PRINT D$;"WRITE "N$;"
150 LIST 60000 - 60071
160 PRINT "RUN 60000"
170 PRINT D$;"CLOSE "N$;"
180 STOP
60000 REM EXTENDED BY E.MCGEOUGH FROM PROGRAM BY RAY CADNUS,MICRO,AUG 1980
60001 HOME
60002 PRINT "VARIABLE LISTER": PRINT : PRINT
60003 PRINT "EXTRACTS AND PRINTS BASIC VARIABLES": PRINT : PRINT
60004 PRINT "AFTER THE FIRST PASS THROUGH"
60005 PRINT "PROGRAM - SORTS - THEN LISTS"
60006 PRINT "ALPHABETICALLY"
60007 FOR D = 1 TO 1999: NEXT
60008 HOME
60009 LL = 60071: REM ** HIGHEST LINE TO EXAMINE - SET TO 59999
60010 PD$ = " "
60011 DIM T$(1000)
60012 REM ** FIND FIRST LINE **
60013 NL = 2049
60014 P = 2049
60015 REM ** RETURN HERE FOR NEXT LINE **
60016 NL = PEEK(P) + PEEK(P + 1) * 256
60017 IF NL = 0 THEN 60053
60018 P = P + 2
60019 LN = PEEK(P) + PEEK(P + 1) * 256: P = P + 1
60020 IF LN > LL THEN 60053
60021 LAB$ = ""
60022 GOSUB 60032: REM GET NEXT ALPHA
60023 LAB$ = LAB$ + CHR$(CH)
60024 GOSUB 60041: REM GET NEXT CHAR
60025 IF CH > 64 AND CH < 91 THEN 60023
60026 IF CH > 47 AND CH < 58 THEN 60023
60027 IF CH = 36 OR CH = 37 THEN 60023
60029 GOSUB 60046
60030 GOTO 60021
60031 REM ** GET ALPHA CHAR
60032 GOSUB 60041
60033 IF CH = 34 THEN GOSUB 60036: GOTO 60032
60034 IF CH = 65 OR CH > 90 THEN 60032
60035 RETURN
60036 GOSUB 60041
60037 IF CH < > 34 THEN 60036
60038 REM GOSUB 60041
60039 RETURN
60040 REM ** GET NEXT CHAR
60041 P = P + 1
60042 IF P = NL THEN POP : POP : GOTO 60015
60043 CH = PEEK(P): IF CH = 178 THEN P = NL: POP : POP : GOTO 60015
60044 RETURN
60045 REM ** STORE LABEL
60046 PRINT LN: "LAB$
60047 X = X + 1
60048 T$ = LAB$
60049 LN$ = STR$(LN)
60050 T$ = LEFT$(T$ + PD$,5)
60051 T$(X) = T$ + RIGHT$(PD$ + LN$,5)
60052 RETURN
60053 Y = XIM$ = Y: PRINT "SORTING -- WAIT": REM ** SHELL SORT **
60054 M$ = INT(M$ / 2): IF M$ = 0 THEN 60061
60055 K$ = Y - M$: J$ = 1
60056 I$ = J$
60057 L$ = I$ + M$: IF T$(I$) < T$(L$) THEN 60059
60058 HH$ = T$(L$): T$(L$) = T$(I$): T$(I$) = HH$: I$ = I$ - M$: IF I$ > = 1 THEN 60057
60059 J$ = J$ + 1: IF J$ > K$ THEN 60054
60060 GOTO 60056
60061 REM ** END OF SORT **
60062 REM ** LIST VARIABLE TABLE **
60063 W = 76: HOME: PR# 2: POKE 33,30: LIST 0 - 60071: POKE 33,40: REM LIST0-5999
60064 FOR C = 1 TO X + 1: IF LEFT$(T$(C - 1),4) < LEFT$(T$(C),4) THEN PRINT T$(C): GOTO 60066
60065 S$ = S$ + RIGHT$(T$(C),6): IF LEN(S$) > W THEN PRINT LEFT$(S$,W): S$ = RIGHT$(PD$ + RIGHT$(S$,6),10)
60066 NEXT C
60067 PRINT CHR$(123) PR# 0
60068 INPUT "LIST AGAIN SLOWLY? " : IZ:
60069 IF IZ = "Y" THEN SPEED = 150: GOTO 60064
60070 SPEED = 255
60071 END
C 60064 60064 60064 60064 60065 60066
CH 60023 60025 60025 60026 60026 60027 60027 60033 60034 60034 60037 60043
60043
60047
D 60007
D$ 100 110 120 130 140 170
LAB$ 60058 60058
L$ 60056 60057 60057 60058 60058 60058 60058 60058
J$ 60055 60056 60059 60059 60059
K$ 60055 60059
L$ 60057 60057 60058 60058
LAB$ 60021 60023 60023 60046 60048
LL 60009 60020
LN 60017 60020 60046 60049
LN$ 60049 60051
M$ 60053 60054 60054 60054 60055 60057 60058
N$ 90 110 120 130 140 170
NL 60013 60016 60017 60042 60043
P 60014 60016 60016 60018 60018 60019 60019 60019 60019 60041 60041 60042
60043 60043
PD$ 60010 60050 60051 60065
S$ 60064 60064 60065 60065 60065 60065 60065 60065 60065
T$ 60011 60048 60050 60050 60051 60051 60051 60057 60057 60058 60058 60058
60064 60064 60064 60065
W 60063 60065 60065
X 60047 60047 60051 60053 60064
Y 60053 60053 60055
Z$ 60068 60069

```

Stock market game

HERE IS a program by Alan Grey of Banbury, Oxfordshire, for a stock-market-type game. It fits easily into an 8K computer and I have added brief instructions, but playing the game would make you understand it more he writes. The program incorporates many problems associated with true investment, i.e., tax, company failure, etc. Brief instructions:

```

10 PRINT "[CLR] (14 SPACES)
   INSTRUCTION (14 SPACES)"
20 PRINT "FOUR MINING
   COMPANIES EXIST FOR INVEST-
   MENT"
30 PRINT "THEY ARE GOLD 1 TIN2
   ZINC 3 LEAD 4"
40 PRINT "YOU START WITH 1000
   CREDITS AND TO WIN"
50 PRINT "MUST SURVIVE TO MAKE
   THIS TO 1000000"
60 PRINT "USE THE CODE NUMBERS
   SHOWN ABOVE WHEN"
70 PRINT "INVESTING, OBEY ALL
   INSTRUCTIONS"
80 PRINT "GIVEN AND.... GOOD
   LUCK!"
90 PRINT "PRESS ANY KEY TO
   START"
100 GET A$:IF A$ = "" THEN 100
110 H$ = 1000:L$ = LEAD:L = 10
120 Z$ = ZINC:Z = 50:T$ = TIN
130 T2 = 250:G$ = GOLD:G = 1250
140 B$ = BANK:B = 20%:Y$ = YOU HOLD
150 H1 = 0:H2 = 0:H3 = 0:H4 = 0
160 GOSUB 11000:GOSUB 20060
170 PRINT "MARKET...NEWS"
180 PRINT L$:GOSUB 11000
190 LET L$ = XZ$:LETL = MB:GOSUB
   1000:LETH1 = HH$
200 LET MB = L:IFT = 1 THEN GOSUB
   5000
210 H$ = INT(RND(1)*9)
220 YI = L/5:PD = H$ - (0.4*YI)
230 PC = INT(PD*YI)
240 IF T = 1 GOTO 270:L1 = L*PC:LET
   L1 = MB2
250 LET L = MB:GOSUB 20000
260 LET L = MB2:MB2 = 0:MB = 0:
   GOSUB 11000
270 PRINT Z$:GOSUB 11000
280 LET Z$ = XZ$:LETT2 = MB:GOSUB
   1000:LETH2 = HH$
290 LET MB = Z:IFT = 1 THEN GOSUB
   5000
300 H$ = INT(RND(1)*9)
310 YI = Z/25:PD = H$ - (0.4*YI)
320 PC = INT(PD*YI)
330 IF T = 1 GOTO 360:Z1 = Z + PC:
   LET Z1 = MB2
340 LET Z = MB:GOSUB 20000
350 LET Z = MB2:MB2 = 0:MB = 0:
   GOSUB 11000
360 PRINT T$:GOSUB 11000
370 LET T$ = XZ$:LETT2 = MB:GOSUB
   1000:LETT3 = HH$
380 LET MB = T2:IFT = 1 THEN GOSUB
   5000
390 H$ = INT(RND(1)*9)
400 YI = T2/125:PD = H$ - (0.4*YI)
410 PC = INT(PD*YI)
420 IF T = 1 GOTO 450:T1 = T2 + PC:LET
   T1 = MB2
430 LET T2 = MB:GOSUB 20000
440 LET T2 = MB2:MB2 = 0:MB = 0:
   GOSUB 11000
450 PRINT G$:GOSUB 11000
460 LET G$ = XZ$:LETT2 = MB:GOSUB
   1000:LETT4 = HH$
470 LET MB = G:IFT = 1 THEN GOSUB
   5000
480 H$ = INT(RND(1)*9)
490 YI = G/625:PD = H$ - (0.4*YI)
500 PC = INT(PD*YI)
510 IFT = 1 GOTO 540:G1 = G + PC:LET

```



```

G1 = MB2
520 LET G = MB:GOSUB 20000
530 LET G = MB2:MB2 = 0:MB = 0:
   GOSUB 11000
540 PRINT B$
550 PRINT B:GOSUB 12000
560 GOSUB 1000:IFT = 1 THEN GOSUB
   5000
570 H5 = H5 + H5/100*B
580 PRINT Y$
590 PRINT H1;" ";L$
600 PRINT H2;" ";Z$
610 PRINT H3;" ";T$
620 PRINT H4;" ";G$
630 PRINT H5;" ";B$
640 GOSUB 20060
650 GOSUB 10000 : GOTO 170
1000 R INT(RND(1)*10)
1010 IF R <> 4 THEN RETURN
1020 PRINT "NEWSFLASH":T = T + 1:
   RETURN
2000 PRINT "PRESS ANY KEY TO
   CONTINUE"
2010 GET A$:IF A$ = "" THEN 2000:
   RETURN
3000 PRINT "SHARE TAKE OVER"
3010 PRINT "SELL AT":X = INT((RND
   (1)*1000) - 700)
3020 IF X > 300 THEN 3010: GOSUB 3040:
   IF TZ$ = 0 THEN RETURN
3030 PRINT X:LETTZ$ = X:H5 = H5 + X:
   RETURN
3040 PRINT XZ$:IF HH$ < 1 THEN
   GOTO 3060
3050 TZ$ = 1:HH$ = HH$ - 1:RETURN
3060 PRINT X:RETURN
4000 PRINT "MARKET...FAILS"
4010 PRINT "BANK TAKEOVER"
4020 PRINT L$ "SELL AT":GOSUB
   4120:PRINT XX$
4030 H5 = H5 + (XX$*H1):XX$ = 0
4040 PRINT Z$ "SELL AT":GOSUB 4130:
   PRINT XX$
4050 H5 = H5 + (XX$*H2):XX$ = 0
4060 PRINT T2$ "SELL AT":GOSUB
   4140:PRINT XX$
4070 H5 = H5 + (XX$*H3):XX$ = 0
4080 PRINT G$ "SELL AT":GOSUB
   4150:PRINT XX$
4090 H5 = H5 + (XX$*H4):XX$ = 0
4100 PRINT Y$:H5:B$
4110 PRINT "GAME ENDED":END
4120 XX$ = INT(RND(1)*20):RETURN
4130 XX$ = INT(RND(1)*100):RETURN
4140 XX$ = INT(RND(1)*500):RETURN
4150 XX$ = INT(RND(1)*2500):RETURN
5000 T1 = INT(RND(1)*2)
5010 R1 = INT(RND(1)*11)
5020 IF R1 = 1 THEN PRINT
   "SUSPENDED":RETURN
5030 IF R1 = 2 THEN PRINT "TIN BONUS
   ISSUE":H3 = H3 + 1:T = 0
5040 IF R1 = 3 THEN PRINT "LEAD
   BONUS ISSUE":H1 = H1 + 1:T = 0
5050 IF R1 = 4 THEN PRINT "ZINC
   BONUS ISSUE":H2 = H2 + 1:T = 0
5060 IF R1 = 5 THEN PRINT "GOLD

```

```

BONUS ISSUE":H4 = H4 + 1:T = 0
5070 IF R1 = 6 THEN GOSUB 3000
5080 IF R1 = 7 THEN GOSUB 4000
5090 IF R1 = 8 AND IF T1 = 1 THEN
   GOSUB 6000
5100 IF R1 = 9 AND IF T1 = 1 THEN
   GOSUB 7000
5110 IF R1 = 10 THEN GOSUB 8000
5120 IF R1 = 11 THEN PRINT "MARKET
   ...SUSPENDED" THEN GOTO 170:
   RETURN
6000 PRINT "TAX BONUS":TT = INT
   (RND(1)*100)
6010 PRINT TT " % ":GOSUB 6040:
   IF NZ = 1 THEN RETURN
6020 H5 = H5 + H5/100*TT
6030 RETURN
6040 TZ = INT(RND(1)*10)
6050 IF TZ = 2 THEN PRINT "TAX
   BONUS SUSPENDED"
6060 TT = 0:TZ = 0:NZ = 1
6070 IF TZ <> 2 THEN NZ = 0:RETURN
7000 PRINT "SUPER TAX":TT = INT
   (RND(1)*100)
7010 PRINT TT " % ":GOSUB 7040
7020 H5 = 5 - (H5/100*TT)
7030 RETURN
7040 TZ = INT(RND(1)*10)
7050 IF TZ = 2 THEN PRINT "SUPER
   TAX SUSPENDED"
7060 IF TZ <> 2 THEN RETURN:TT = 0:
   TZ = 0:RETURN
8000 PRINT XZ$ "BONUS":TT = INT
   (RND(1)*100)
8010 PRINT TT " % ":GOSUB 8040
8020 MB = MB + MB/100*TT
8030 RETURN
8040 TZ = INT(RND(1)*10)
8050 IF TZ = 2 THEN PRINT "BONUS
   SUSPENDED"
8060 IF TZ <> 2 THEN RETURN:TT = 0:
   TZ = 0:RETURN
9000 PRINT "TO SEE BANK BALANCE
   PRESS $":FOR N = 0 TO 2000:NEXT N
9010 GET A$:IF A$ = "" THEN GOTO
   9000:IF A$ = "$" THEN GOSUB 9030
9020 RETURN
9030 PRINT "BANK BALANCE IS ":H5
9040 RETURN
10000 GOSUB 9000
10010 PRINT "FOR MARKET NEWS
   PRESS A":GET A$
10020 IF A$ = "A" THEN GOTO 170:FOR
   N = 0 TO 2000:NEXT N
10030 INPUT "PLEASE TYPE NUMBER
   OF UNITS" ZI$
10040 INPUT "PLEASE TYPE CODE
   NUMBER" XI$
10050 INPUT "PLEASE TYPE BUY OR
   SELL" Y2$
10070 IF XI$ < 1 OR > 4 THEN GOSUB 10240
   THEN 10040
10080 IF XI$ <> INT XI$ THEN GOSUB
   10240 THEN 10040
10090 IF XI$ = 1 THEN LET XI$ = GOLD
10100 IF XI$ = 2 THEN LET XI$ = TIN
10110 IF XI$ = 3 THEN LET XI$ = ZINC
10120 IF XI$ = 4 THEN LET XI$ = LEAD
10130 PRINT Y2$;" ";ZI$;" ";XI$
10140 GOSUB 9000
10150 IF XI$ = GOLD THEN XI$ = G THEN
   LET VV$ = H4
10160 IF XI$ = TIN THEN XI$ = T2 THEN
   LET VV$ = H3
10170 IF XI$ = ZINC THEN XI$ = Z THEN
   LET VV$ = H2
10180 IF XI$ = LEAD THEN XI$ = L THEN
   LET VV$ = H1
10190 TE = INT(RND(1)*10)
10200 IF TE = 1 THEN RETURN
10210 IF Y2$ = BUY THEN GOTO 10220
10220 IF Y2$ = SELL THEN GOTO 10260:
   GOTO 10050
10240 IF (VV$*2L$) - H5 < 0 THEN PRINT
   "OVERDRAWN" THEN GOTO 10030
10250 H5 = H5 - (XI$*ZI$):GOTO 10250
10260 PRINT "FRAUD":RETURN

```



```

10270 VV$ = VV$ + ZIS:GOTO 10310
10290 IF ZIS > VV$ THEN PRINT "FRAUD"
      THEN 10030
10300 IF ZIS <> INT ZIS THEN PRINT
      "FRAUD" THEN 10030
10310 H5 = H5 + (XIS*ZIS)
10320 VV$ = VV$ - ZIS:GOTO 10310
10340 H5 = H5 + H5/100*B:GOSUB 11000:
      GOSUB 20060
10350 GOTO 170
11000 T=0:OZ=0:R=0:XX=0:H5=0:YI=
      0:TT=0:PC=0:R1=0:T1=0:NZ=0:
      TZ$=0:RETURN
12000 TV$ = INT(RND(1)*20):GET TV$:LET
      B = TV$:RETURN
20000 IF MB > MB2 THEN OZ = MB - MB2
      THEN GOTO 20040
20010 IF MB < MB2 THEN OZ = MB2 - MB
      THEN GOTO 20050
20020 IF MB = MB2 THEN PRINT
      "HOLD";MB2
20030 RETURN
20040 PRINT OZ;" DOWN ";MB2:RETURN
20050 PRINT OZ;" UP ";MB2:RETURN
20060 PRINT "(40 shifted eights)":RETURN
    
```

Snoopy plotter

I WAS playing about with Pet, when I suddenly realised that there was no pound sign writes Jeremy Cook of Leicester. As I desperately needed one for a printout, I dragged out my old magazines looking for an article which, I vaguely remembered, gave details of a printer pound sign.

I found it at last in the February issue of *Practical Computing* and, as soon as I realised how easy it was, I started experimenting with my own characters. It did not take long to realise that a picture any size could be formed from an arrangement of dots on the printer. Grabbing a sheet of graph paper, I started looking for something to draw.

The first thing I found was a picture of Snoopy so I traced the outline on to my sheet of millimetre-squared graph paper and started to fill in every square where a line crossed. That gave a picture of Snoopy consisting of little squares. When that was done, I divided the picture into seven by six characters, 195 of them, and started the laborious job of converting the characters into data.

I drew the first line with the top of Snoopy's goggles as an enlargement on a coding farm. In binary code, 00000011 = 3; translating the picture into data is no more complicated. The first five characters are blanks so the data is 0,0,0,0,0 for each character — one number for each column.

The sixth character has two blank columns, then a column with two dark squares corresponding to binary 0000011 the next dark square — binary 0000100 — and so on, giving the sixth character defined in data as 0,0,3,4,11,20. Every data statement is formed in that way, rather laborious, but worthwhile.

The program occupies lines 100-200 and works like this: PRINT #6, CHR\$(9) gives a line feed of one character so that each line will be exactly touching the line above, then the line feed is reduced so that the paper will not move by PRINT #6,

CHR\$(1) while a line of print is set-up.

The printer head will go back and forth seven or eight times to create each line. That must be done because if you try to send all the defined characters at once, only the last one sent will be printed repeatedly. The paper is then fed for the next line.

The first line of program contains constants used throughout the program and are the only items which may need to be altered to make the program work for your particular picture which you want to print. L is the number of lines in the picture — 15 in this case. W is the width in characters of the program. Note WXL gives the total number of pre-defined characters as a check.

The constants N and CO give the number of copies across and down respectively. The variable R8 which occurs on line 160 and 170 is a time saver and stops the printer working when it has a blank to print. If you want to increase the spacing between individual pictures, line 185 FOR D=B+1 TO W+1 can be changed to FOR D=B+1 TO W+X where X is an integer greater than 1. That will increase the horizontal spacing. To increase the spacing vertically, line 195 PRINT #6, CHR\$(Y) where Y is an integer between 25 and 255.

It should be easy to print almost anything using this method, your own drawings photographs if you can trace through the graph paper, and pictures from magazines are just some suggestions. However, it should be remembered that from millimetre-squared graph paper, the image is reduced to approximately a quarter of the original size.

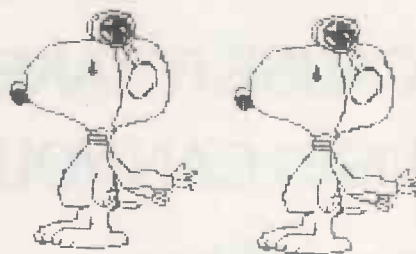

SNOOPY

READY.

```

100 L=15:H=13:N=5:CO=5
110 OPEN 4,"OPEN6,4,6":OPEN5,4,5
111 FOR F=1 TO CO
115 PRINT#6,CHR$(1)
130 RESTORE
140 FOR A=1 TO L:PRINT#6,CHR$(9):PRINT#4 PRINT#6,CHR$(1)
150 FOR B=1 TO H:RS="" :RS=0
160 FOR C=1 TO W:READP:RS=R+CHR$(R) :RS=RS+R :NEXT C
165 IF RS=0 THEN 190
170 PRINT#5,RS
175 FOR E=1 TO N
180 FOR D=B+1 TO W:PRINT#4," "; :NEXT PRINT#4,CHR$(254)
185 FOR D=B+1 TO W+1:PRINT#4," "; :NEXT NEXTE
186 PRINT#4
190 NEXT A
194 NEXT B
195 PRINT#6,CHR$(24) :PRINT#4:NEXT F
200 CLOSE 4 :CLOSE 5:PRINT#6,CHR$(24) :CLOSE 6:END
1010 DATA 0,0,0,0,0
1020 DATA 0,0,0,0,0
1030 DATA 0,0,0,0,0
1040 DATA 0,0,0,0,0
1050 DATA 0,3,4,11,20
1060 DATA 24,35,39,45,93,89
1070 DATA 95,95,95,47,47,47
1080 DATA 51,12,3,0,0
1090 DATA 0,0,0,0,0
1100 DATA 0,0,0,0,0
1110 DATA 0,0,0,0,0
    
```

```

1120 DATA 0,0,0,0,0
1130 REM 2
1140 DATA 0,0,0,0,0
1150 DATA 0,0,0,0,0
1160 DATA 0,0,0,0,0
1170 DATA 0,0,0,0,0
1180 DATA 1,1,1,1,1
1190 DATA 2,114,110,126,6
1200 DATA 123,109,102,114,123
1210 DATA 127,127,127,63,31,89
1220 DATA 110,125,58,124,4,4
1230 DATA 4,4,2,2,1
1240 DATA 0,0,0,0,0
1250 DATA 0,0,0,0,0
1260 DATA 0,0,0,0,0
1270 REM
1280 DATA 0,0,0,0,0
1290 DATA 0,0,0,0,0
1300 DATA 3,4,8,16,32
1310 DATA 32,64,64,64,64
1320 DATA 0,0,0,0,0
1330 DATA 0,0,0,0,0
1340 DATA 0,0,64,64,96
1350 DATA 32,63,32,32,112
1360 DATA 76,23,96,24,16,3
1370 DATA 0,0,0,0,0
1380 DATA 4,96,30,7,0,0
1390 DATA 0,0,0,0,0,0
1400 DATA 0,0,0,0,0,0
1410 REM
1420 DATA 0,0,0,0,0,0
1430 DATA 0,3,12,24,32
1440 DATA 0,0,0,0,0,0
1450 DATA 0,0,0,0,0,0
1460 DATA 0,0,0,0,0,0
1470 DATA 0,0,14,127,63
1480 DATA 0,0,0,0,0,0
1490 DATA 0,64,60,7,0
1500 DATA 1,110,56,16,32
1510 DATA 96,96,96,48,24
1520 DATA 5,0,64,124,15
1530 DATA 0,0,0,0,0,0
1540 DATA 0,0,0,0,0,0
1550 REM
1560 DATA 0,7,12,9,9
1570 DATA 5,127,0,0,0,0
1580 DATA 0,0,0,0,0,0
1590 DATA 0,0,0,0,0,0
1600 DATA 0,0,0,0,0,0
1610 DATA 0,0,0,0,0,0
1620 DATA 0,0,0,0,0,0
1630 DATA 0,0,0,1,24,3
1640 DATA 28,99,1,0,0,0
1650 DATA 0,1,3,6,28
1660 DATA 120,0,0,0,1,27
1670 DATA 0,0,0,0,0,0
1680 DATA 0,0,0,0,0,0
1690 REM
1700 DATA 0,96,120,124,126
1710 DATA 126,126,124,60,12,4
1720 DATA 2,1,1,0,0,0,0
1730 DATA 0,0,0,0,0,0,0
1740 DATA 0,0,0,0,0,0,0
1750 DATA 0,0,0,0,0,0,0
1760 DATA 0,0,0,0,0,0,0
1770 DATA 0,0,3,126,0
1780 DATA 0,64,96,32,32
1790 DATA 32,64,64,0,0,0
1800 DATA 0,0,3,28,112
1810 DATA 0,0,0,0,0,0,0
1820 DATA 0,0,0,0,0,0,0
1830 REM
1840 DATA 0,0,0,0,0,0,0
1850 DATA 0,0,0,0,0,0,0
1860 DATA 0,64,64,32,32
1870 DATA 32,15,16,16,16
1880 DATA 0,4,4,4,2
1890 DATA 2,1,1,0,0,0,0
1900 DATA 0,0,0,0,0,0,0
1910 DATA 0,12,112,0,1
1920 DATA 3,2,2,6,4
1930 DATA 4,4,12,8,16
1940 DATA 16,32,64,64,0,0
1950 DATA 0,0,0,0,0,0,0
1960 DATA 0,0,0,0,0,0,0
1970 REM
1980 DATA 0,0,0,0,0,0,0
1990 DATA 0,0,0,0,0,0,0
2000 DATA 0,0,0,0,0,0,0
2010 DATA 0,0,0,0,0,0,0
2020 DATA 0,0,0,0,0,0,0
2030 DATA 0,64,48,23,29
2040 DATA 21,37,37,37,23
2050 DATA 120,48,64,64,0
2060 DATA 0,0,0,0,0,0,0
2070 DATA 0,0,0,0,0,0,0
2080 DATA 0,0,0,0,0,0,0
2090 DATA 0,0,0,0,0,0,0
2100 DATA 0,0,0,0,0,0,0
2110 REM
2120 DATA 0,0,0,0,0,0,0
2130 DATA 0,0,0,0,0,0,0
2140 DATA 0,0,0,0,0,0,0
2150 DATA 0,0,0,0,0,0,0
2160 DATA 0,0,0,0,0,0,0
2170 DATA 6,12,16,96,32
2180 DATA 32,96,32,32,127
2190 DATA 28,7,0,0,0,0,0
2200 DATA 0,0,0,0,0,0,0
2210 DATA 0,0,0,0,0,0,0
2220 DATA 0,0,0,0,0,0,0
2230 DATA 0,0,0,0,0,0,0
2240 DATA 0,0,0,0,0,0,0
2250 REM
2260 DATA 0,0,0,0,0,0,0
2270 DATA 0,0,0,0,0,0,0
2280 DATA 0,0,0,0,0,0,0
2290 DATA 0,0,0,0,0,0,0
2300 DATA 3,4,24,32,64
2310 DATA 0,0,0,0,0,0,0
2320 DATA 1,0,0,0,96
2330 DATA 12,3,64,96,48
2340 DATA 12,6,2,2,2,2
2350 DATA 4,4,4,4,4,4
2360 DATA 6,2,1,1,1,1
2370 DATA 3,4,12,16,32
2380 DATA 5,2,5,6,6
2390 REM
2400 DATA 0,0,0,0,0,0,0
2410 DATA 0,0,0,0,0,0,0
2420 DATA 0,0,0,0,0,0,0
2430 DATA 0,0,0,0,0,0,0
2440 DATA 12,0,0,0,0,0,0
2450 DATA 0,0,0,0,0,0,0
2460 DATA 31,96,0,0,0,0,0
2470 DATA 3,125,111,17,12
2480 DATA 2,3,2,2,2
2490 DATA 4,4,4,4,4,4
2500 DATA 3,2,2,2,3
2510 DATA 2,125,8,36,36
2520 DATA 100,104,46,18,16
2530 REM
2540 DATA 0,0,0,0,0,0,0
2550 DATA 0,0,0,0,0,0,0
2560 DATA 0,0,0,0,0,0,0
2570 DATA 0,0,0,0,0,0,0
2580 DATA 0,0,0,0,0,0,0
2590 DATA 3,4,28,17,18
2600 DATA 0,0,0,0,0,0,0
2610 DATA 32,65,66,68,72
2620 DATA 16,16,16,16,16
2630 DATA 16,16,16,16,16,16
2640 DATA 64,64,64,64,64
2650 DATA 0,0,0,0,0,0,0
2660 DATA 0,0,0,0,0,0,0
2670 REM
2680 DATA 0,0,0,0,0,0,0
2690 DATA 0,0,0,0,0,0,0
2700 DATA 0,0,0,0,0,0,0
2710 DATA 0,0,0,0,0,1
2720 DATA 65,65,65,65,66
2730 DATA 96,96,64,64,0
2740 DATA 7,0,0,0,0,0,0
2750 DATA 31,32,96,64,0,0,0
2760 DATA 64,64,64,64,64,64
2770 DATA 0,0,0,0,0,0,0
2780 DATA 0,0,0,0,0,0,0
2790 DATA 0,0,0,0,0,0,0
2800 DATA 0,0,0,0,0,0,0
2810 REM
2820 DATA 0,0,0,0,0,0,0
2830 DATA 0,0,0,0,0,0,0
2840 DATA 3,4,28,17,18
2850 DATA 0,0,0,0,0,0,0
2860 DATA 16,16,16,16,16,16
2870 DATA 16,16,16,16,16,16
2880 DATA 64,0,0,0,0,0,0
2890 DATA 96,56,8,8,8,8
2900 DATA 4,3,0,0,0,0,0
2910 DATA 0,0,0,0,0,0,0
2920 DATA 0,0,0,0,0,0,0
2930 DATA 0,0,0,0,0,0,0
2940 DATA 0,0,0,0,0,0,0
2950 REM
2960 DATA 0,0,0,0,0,0,0
2970 DATA 0,0,0,0,0,0,0
2980 DATA 0,0,0,0,0,0,0
2990 DATA 32,112,16,16,48
3000 DATA 104,8,8,24,40
3010 DATA 8,8,8,8,8,8
3020 DATA 8,8,8,8,8,8
3030 DATA 16,16,16,16,16,16
3040 DATA 32,96,0,0,0,0,0
3050 DATA 0,0,0,0,0,0,0
3060 DATA 0,0,0,0,0,0,0
3070 DATA 0,0,0,0,0,0,0
3080 DATA 0,0,0,0,0,0,0
    
```

READY.

Applesoftware from Leicester Computer Centre

the correspondent

by R. Wagner

★ Now with mathematics routine ★

THE CORRESPONDENT is sure to be one of the most versatile programs in your library! It can be used as:

A Text Processor: Upper/lower case, 1-80 cols. (4-way scrolling). Text move/copy/insert/delete, tabbing, justify text, auto-centering and more!

A Database (with or without printer!) Extremely fast find routine and easy editing make it a natural for free-form data files. Create and fill out forms, access phone lists or index your magazines.

A Programming Utility: (printer or not). Examine, edit, transfer random or sequential text files. Create versatile exec. files. Even put bi-directional scrolling in your own programs!

Apple disk £29.95 + VAT

Roger's Easel

by R. Wagner

At last a program which allows you to draw colour pictures in lo-res graphics, and then permanently link them to your own Integer or Applesoft programs. Linked pictures can be displayed on either text/graphics page. (Integer basic).

Apple disk £14.95 + VAT

Apple-Doc By Roger Wagner

An Aid to the Development and Documentation of Applesoft Programs

This 3 program set is a must to anyone writing or using programs in Applesoft! It not only provides valuable info. on each of your programs, but allows you to change any element throughout the listing almost as easily as you would change a single line!

With Apple-Doc you can produce a list of every variable in your program and the lines each is used on, each line called by a GOTO, GOSUB, etc., in fact, every occurrence of almost anything! You can rename variables, change constants and referenced line numbers or do local or global replacement editing on your listing.

Apple-Doc is a must for the serious Applesoft programmer.

Diskette complete with full documentation £24.95 + VAT

tridee ©Robin L. Frost

PASCAL—FORTRAN COMPATIBLE An exciting new addition to your Pascal library — enables you to create 3D graphics, viewable from any angle and distance. As easy to use as Turtlegraphics. Procedures include Ortho, Perspec, Rotate, View, Move to-3, View-from. Complete with comprehensive instructions

£49.95 + VAT

Apple World is here. The fast 3D graphics package that runs on your Apple II plus. Zoom, pan, tilt and scale your own designs on the Apple screen, at only £24.95 + VAT

Plus a complete range of "off the shelf" programs for finance, commercial, scientific and education. Keep yourself up to date, send for our "Fact Sheets" giving full program details.

Now available Apple FORTRAN, Dos 3.3, Apple Plot

LEICESTER
computer centre limited

67 Regent Road, Leicester LE1 6YF. Tel: 0533 556268

apple computer
Sales and Service

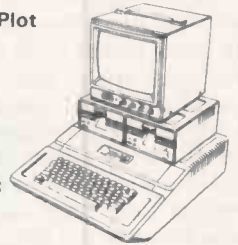

Apple III! Send for details now

• Circle No. 181

"TYPING REPORTS AGAIN & AGAIN?"

"WE DON'T MAIL OUR CUSTOMERS BECAUSE IT TAKES TOO LONG." IN 1981 CAN YOU AFFORD THIS?"

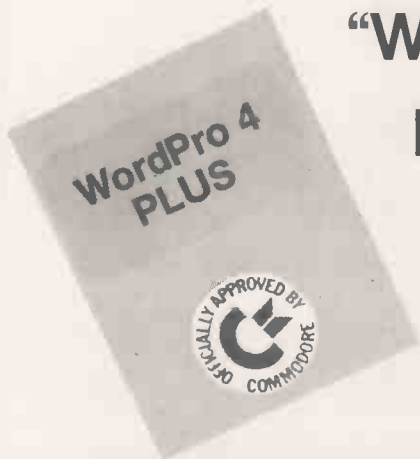

Everyone expected it would happen sooner or later... with WordPro PLUS™ it already has! Now all the marvelous benefits of expensive and advanced word processing systems are available on Commodore computers, the U.K.'s largest selling computer line. WordPro PLUS, when combined with the new 80 column CBM 8032, creates a word processing system comparable to virtually any other top quality word processor available—but at savings of thousands of pounds!

New, low cost computer technology is now available at a fraction of what you would expect to pay. This technology allowed Commodore to introduce the new and revolutionary CBM 8032 Computer.

WordPro PLUS turns this new CBM 8032 Computer into a sophisticated, time saving word processing tool. With WordPro PLUS, documents are displayed on the computer's screen. Editing and last minute revisions are simple and easy. No more lengthy re-typing sessions. Letters and documents are easily re-called from memory storage for editing or printing with final drafts printed perfectly at over five hundred words per minute!

Our nationwide team of professional dealers will show you how your office will benefit by using WordPro PLUS. At a price far less than you realize.

Invest in your office's future...
Invest in WordPro PLUS...
Call us today for the name of the
WordPro PLUS dealer nearest you.

Professional Software Ltd.
25 Station Road
New Barnet
Hertfordshire ENS 1PH
Telephone: 01-441 2397

CBM is a registered trademark of
Commodore Business Machines.

• Circle No. 182

Mice in the aftermath

AFTER THE weeks, if not months, of frantic activity for the 1980 Micromouse competition, by now all the competitors should have returned to earth. Some mice will undoubtedly have been flattened by frustrated handlers. Others, like Sterling Mouse, will have been hidden away in plastic bags, to re-emerge for special occasions.

I know that Brainy Bricks — built from Lego — has been dismantled and returned to its owners' children. Yet while some old contestants are saying never again, others are already plotting new surprises for the 1981 competition. I am told there are already 10 new entrants on the path which may lead to potential divorce, despair, frustration and elation.

In 1980, there were about 200 enquiries, 100 entries, but only nine mice at the finals. At a preliminary trial in July there were five, but of these only two survived to fight again at the finals. The statistics should convince you that the competition is not a joke or a game. It is very serious, very hard work, great fun and very rewarding if you live to tell the tale.

There is nothing quite like building something with your own hands and seeing it move for the first time. Obviously, one cannot compare an electro-mechanical mouse to anything alive. Nevertheless, every mouse has its own character which can be moulded by adjustments to its hardware and software. By the end of the three days leading to the London final, I believe I could have named more than half the mice by their sound alone.

Anyone who saw the competition or read the reviews will know that the performance of the mice left much to be desired. Over the three days, only Sterling Mouse reached the centre of the maze and knew it had arrived there.

It also found the shortest route from start to finish on the test maze, though it crashed irretrievably in the finals. Brainy Bricks discovered the centre of the maze once in practice by thrashing about at random for a long time. None of the others ever had any success.

Secrets of success

What went wrong? What is the secret? People could be forgiven if they believed the secret was not working for a major electronics company or university, and not having any money or resources. Sterling Mouse — built by my next door neighbour Geoff Pike and myself — cost about £150.

Brainy Bricks, the other private entry — built by Phil Yeardley and Pete Gissings — cost less than £100. Midnight Sun, the entry from Finland, and the mouse I would most like to own — excluding Sterling — cost £2,500 and will be worth every penny if they ever resolve the steering problems.

The Micromouse page is for anything that moves. It is edited by Nick Smith who won the 1980 European Micromouse Competition. The aim is to help readers who do not have a clue where to start, learn enough to enter, and perhaps win, the 1981 competition. We will pay the usual £5 for each idea published.

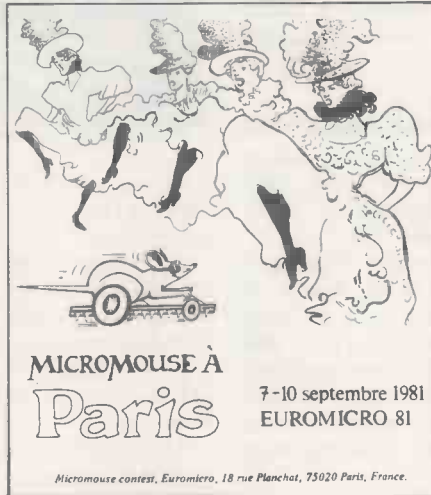

Everyone said that if they started again they would do it all differently. What that means in practice is that the mice will be the same next year but the owners will have swapped. I believe the answers are lack of time, lack of thought, and an inability to learn from experience and advice.

You cannot expect to build a successful mouse in a few weeks and then hope to make it work by clever software as most of the teams seemed to think. You must conceive the total entity properly from the start.

Best example

You must learn from experience and be prepared to re-build some or all of your mouse. The best example of that is the Plessey mouse. At the July trial, I was very pleased to see that the sensors on Fred, the Plessey mouse, were badly located. Imagine my dismay when John Billingsley, the competition organiser, told the Plessey team where to put their sensors in his review of the trial, but they failed to heed his advice.

What is the secret? I believe it is to spend a long time on the overall design of the mouse. That means software as well as hardware. It is obtaining the correct balance between the two which can make life easy or next to impossible. I was fortunate in that I knew nothing about motor control or electronics when I started building Sterling Mouse.

That meant I had to spend a long time thinking about design and trying to minimise the electronics content. At the same time, being an analyst and programmer by trade, I found it natural to think about how the software could make most use of the hardware knowledge I

had. Had I known more about electronics or had more resources, I would almost certainly have made the mistake of designing and building a mouse with the fond belief that I could write the software to make it work later.

Skidding problems

On a more detailed level, the biggest problem, after software, was undoubtedly skidding. A learning mouse has to know exactly where it is all the time. That is usually monitored by counting wheel revolutions. A skidding wheel is therefore fatal. While on the subject of wheels — do not expect the floor of the maze to be flat.

If you have more than three wheels, and no suspension, at least one wheel — probably a drive wheel — will be off the ground. The Swiss mouse was trapped in a dip. Midnight Sun had wall sensors with a limited operating range. Unfortunately, the steering algorithm could not keep the mouse within the operating range of the sensors. The moral is; do not assume you need sensors only for fine tuning. Make them operate over the maximum possible physical movement of the mouse.

Sterling Mouse was not perfect in the sensor department either. Sterling's sensors were mechanical wings pressing against the side walls. What I forgot was the enormous amount of friction that generated, not to mention the notches and lumps in the walls literally pulling the mouse off course.

That is important if you are using stepper motors which do not generate much power. At the lowest level Brainy Bricks used microswitches with long thin flexible wire feelers. Unfortunately, the wire had a nasty tendency to catch in joints in the maze walls.

If I have not put you off yet, I have one last piece of advice. Having designed and planned your mouse, build-in a crash-recovery routine. No matter how hard you try, or how inconceivable it is, something unexpected will always upset your mouse; they are temperamental beasts.

Software king?

ARE YOU a software king and are looking for your ideal partner — an electronics expert — or the other way round? Are you looking for someone of a like mind to talk to, because your wife does not understand you? The Micromouse Marriage Bureau could be the answer. Write, with your vital statistics, i.e., software, hardware and mechanical abilities, and I will try and put you in touch with an ideal partner. □

Programming the Z-8000

By Richard Mateosian published by Sybex 1980, ISBN 089588-032-6.

MATEOSIAN introduces the techniques, skills and information required to program the Z-8000 series of microprocessor. Many of the chapters are written round specific problems in which the techniques and information required for the solution to the problems are presented.

In that way, the concepts of flowcharts, algorithms and sub-routines are dealt with in the earlier part of the book. The instruction set is introduced in the same manner together with addressing modes. That technique is used finally to present sample programs to perform tasks such as user terminal control and time-sharing monitor functions.

Within many of the chapters are exercises which give the reader a chance to test his newfound knowledge — answers to selected exercises are given.

The book starts with a brief introduction to number systems such as Hex arithmetic, two's complement representation for signed numbers and floating-point format. Concepts such as algorithms and flowcharts are also introduced.

That is followed by a chapter on the Z-8000 internal registers, dealing with the general-purpose registers and their configurations, the status and control-word structure and describing interrupt trap handling. Programming is dealt with by building a program for encryption of data. A chapter describes the instruction set and gives full details of each instruction and of addressing modes and a treatment of software techniques for input/output functions.

The remainder of the book consists of sample programs to cover applications such as text handling from a terminal and time-sharing operating systems. A brief mention is made of utilities such as assemblers, text editors and debug routines.

Although the book builds-up from simple concepts, it moves quickly to complex information presentation and some knowledge of the simpler structure of eight-bit microprocessors would help the reader

understand the more sophisticated operation of the 16-bit machine.

Conclusions

- The book is a comprehensive description of the Z-8001 and Z-8002 micros.
 - Some familiarity with microprocessor terminology is useful.
 - A good source of sample programs.
- Brian White

Living with the micro

by Martin Banks, published by Sigma Technical Press, 1980, 150 pages soft cover, £4.50. ISBN 0-905104-11-0.

MANY newcomers to computing must wonder where on earth to start; how to learn enough of the basics to be able to read the magazines and books at their local shops; how to understand enough to know if they want to learn some more.

Increasingly, the small businessman finds himself needing that understanding. Can the new machines save time and money? How much time? How much money? What are the snags? Until recently most introductions to computing assumed you wanted to learn to program. Chapter one discussed binary long-division and the differences between ASC11 and EBCDIC; few small businessmen ever reached chapter two.

During the last year or so, however, publishers have rushed to fill the gap. Several books have appeared aimed at the small businessman but equally useful to any interested novice. Those books fit a standard pattern — they start with some history, give a description of computer architecture at a high-enough level to be equally applicable to ENIAC or a Z-8000, describe a few systems — Apple, Pet, TRS-80 are almost certain to be included — and peripherals, touch on programming and languages and then move on to applications packages, custom-built programs and do-it-yourself.

That is scarcely surprising — they are the difficult topics which are important for the intended readers, and it is difficult to present the same information in a way which is totally different from the other books on sale.

Martin Banks has written a good example of that kind of



book; one which can be recommended to anyone wanting some insight into computing and the potential of microprocessors. It covers teletext, viewdata and communications as well as stand-alone computing, wrapping it up in the grand name of information technology.

That tempts the author into occasional jargon; for example: "The microprocessor has fundamentally changed the cost-benefit equations by incorporating within the physical and financial confines of the integrated circuit the functional capabilities of a computer".

The book is intended for the novice. It is deliberately superficial, so that it is readable and can cover a good deal of ground. It would be mistaken to expect every detail to be correct; that is not important, and a pedantic attention to trivialities might spoil the flow and structure of the narrative; For the intended reader it will make a splendid introduction.

Conclusions

- A good introduction to the new technology for the small-business user or other interested novice.
 - It should be used only as an introduction, however.
 - Readers wanting detailed information about any topic should read the books listed in the bibliography, or recommended by a trusted advisor.
- Martyn Thomas

The CP/M handbook with MP/M

by Rodnay Zaks Sybex.

THE CP/M Handbook is precisely what is says, and is more nearly what the CP/M manual should be than it is. The handbook is a thick document — 320 pages — but the naive

reader should not be deterred by that — the parts of CP/M that one uses mainly need only a few pages.

It assumes no more than that you have a computer and that the room light is on. There is, for instance, a photograph of how to put a disc into the drive — and that is no trivial matter for someone who does not know, since the disc has four edges and two sides and there are consequently eight different ways to put it in, of which only one is right.

It takes the reader through all the functions of CP/M 1.4 and 2.2 and MP/M — MP/M is the system for computers with multiple terminals — not to be confused with a network system which links multiple computers together. The treatment is narrative in the first half of the book, and in the second half each command has a page to itself and is defined formally. To finish with, there are a number of summary tables and an indices.

Conclusions

- The professional programmer will probably not sit up all night with this book.
 - It would be worth having around if inexperienced people have to use CP/M systems.
- Peter Laurie

Computers and microprocessors made simple

By G H Olsen and I Burdess. Published by W H Allen, October 1980, at £2.50 paperback. ISBN 0 491 02793 1. Also available hardback at £4.95, ISBN 0 491 02893 8.

THIS introduction to computer logic and hardware design is the latest addition to the Made Simple Educational Books series. As usual with the series, it represents excellent value for money, providing a great deal of factual information at a price which even sixth-form and college students can readily afford.

It is very much a hardware introduction. It starts with the concepts of mathematical analogues and from that foundation, develops the basic design and operation of analogue computers. This section relies heavily on simple differential calculus, so it may prove difficult to follow in detail if the

reader lacks the necessary mathematical background.

Most of the book is, however, devoted to the digital computer; the mathematics used is restricted to arithmetic and Boolean algebra, and all the necessary explanations are provided.

Digital circuit design is introduced from first principles; by showing the effects of the basic logic elements in terms of relay logic. The equivalent circuits are then developed firstly in diode-register logic, then in diode transistor and transistor-transistor logic (TTL).

The authors show how those logic elements can be used to design adders, counters and shift registers; from that, the architecture of a small digital computer is developed and explained.

By this stage, the reader has sufficient background understanding to be able to follow an explanation of instruction sets, addressing modes and interfacing. Programming is introduced as an exercise in numerical machine-coding, then the functions of an assembler are explained and the existence of higher-level languages is mentioned.

The book will undoubtedly prove useful to students taking A-level, City and Guilds or similar courses; it will also interest the lay reader with a strong interest in computer hardware design.

One word of warning, though: readers who buy this book hoping for a useful introduction to computing which will lead on to the purchase of a personal system, or readers who expect to acquire useful information on attaching special peripherals to their Apple, Pet or TRS-80 may be disappointed. The information here is more theoretical and more basic than such readers probably want.

Conclusions

- An excellent addition to this good-value series, recommended strongly to students or anyone who wants to understand the principles of computing from the viewpoint of the electronic engineer.
- At this low price, readers may be tempted to buy, hoping for an introduction to personal computing or to the social impact of computers.

● That would be a mistake — the authors are aiming at another market and their book would be quite unsuitable for any such purpose.

Integrating the computer with your business.

By Porter and Chapple, edited by R B Yearsley, HFL Publishers Ltd. £9.50 paperback. ISBN 0 372 30032 4.

THE subtitle is Accounting for Computer Charges and coupled with the main title, reveals the surprising subject matter of the book. The authors believe that many companies are suffering because their computing department — dp division, management services section or whatever — is not properly part of its parent company, treated equally with other departments and with its true costs and resource utilisation properly visible.

They further believe that the situation can be corrected by detailed cost-accounting combined, ideally, with internal charging of other departments for computing resources used.

Most of the book is devoted to a detailed explanation of how costs can be calculated and minimised and how appropriate charges can be assessed and levied. That may sound as though the book would interest only company directors but, in fact, its appeal is far wider than that.

In covering their intended subject, the authors have provided a comprehensive guide to running a dp department. The fact they have provided plentiful examples from real departments and real projects will provide fascinating reading and comparison for dp managers.

At the same time, businessmen who are considering introducing or expanding the use of computers in their businesses will find that the book provides a useful insight into many of the implications and possible pitfalls.

On the negative side, it could be argued that it is too superficial in approach, yet too detailed and dogmatic in application. That is a charge which can be levelled against most management books, since the techniques of good management can be seen, with

hindsight in any particular instance, to be plain common-sense. There is always a wide range of ways in which any particular principle can be applied in practice.

Nevertheless, a book of this kind provides a valuable compendium of techniques and principles, and the detail of the examples illustrates the techniques and gives them greater credibility and meaning.

At £9.50 for 300 paperback pages, the book is expensive, although the majority of copies will probably be set against tax in some way. The general reader may find it interesting; any public library will be able to supply a copy.

Conclusions

- Mainly for the managers of large businesses with separate computing departments, rather than the local newsagent contemplating buying a small microcomputer system.
- Recommended for the former class of readers; interesting reading for the latter.

Programming microcomputers with sample programs.

By Stanley J Evans. Prentice/Hall International. £10.35 hardback, ISBN 0-8359-5683-0.

THERE are three elementary requirements for any introductory text: it must be correct in text and examples; the order in which information is presented must be logical and designed for beginners; it must not contain superfluous, confusing detail. This book fails on all three counts.

It is in two parts. Part I describes basic concepts of computers and programming, touches on Fortran and Cobol covers Basic and PL/M in some detail, and finishes with an overview of APL.

Part II contains reference tables for ASCII and binary-to-Hexadecimal-to-decimal-to-binary conversion, and the sample programs of the title: a number-base conversion program and a Dow-Jones Industrial Average Forecaster both in Basic and neither of much interest.

That sounds a reasonably attractive package, but closer reading reveals the flaws. The

author appears to have an electronic engineering background, and his introduction to computer basics is very low-level in approach and hops erratically and confusingly from topic to topic.

It is as if Evans had jotted down a list of headings as they occurred to him and then expanded each one, with no attempt to establish relevance or a useful order. His examples are too often incorrect and they display an unfortunate and amateurish leaning towards obscure and ill-structured programming.

Consider, for example this extract from page 65

The following is a useful way of using relational operators:
 $125 A = -(B > C) * B - (B < C) * C$

This statement will set the variable A to MAX(B,C) = the larger of the two variables B and C.

As the author has omitted to mention that true and false have the numerical values —1 and 0 respectively, the unfortunate reader is left confused, at best. At worst, the reader might believe that this is good programming style, rather than an advanced trick used only if desperately short of memory or processor power.

One minor good point about the text is that on page 49 the author distinguishes clearly between programming a microcomputer — which is just programming — and microprogramming — which is the specialised task of building the instruction set of a microprogrammable computer by specifying the logical actions performed by each internal element of the processor in executing a single machine-code instruction. Unfortunately, part 1 of his book is called Microprogramming theory and examples — exactly the wrong use of which he complains.

The best section of the book is the chapter on PL/M which is a perfectly acceptable introduction to this useful language. Nevertheless, one good chapter — even one of 78 pages — cannot completely redeem an otherwise mediocre book.

Conclusions

- Mediocre and occasionally misleading.
- The book is not recommended to any class of readers.
- There are many, far better, introductions to programming available. *Martyn Thomas*

Almarc + Vector Graphic

The complete partnership
in Micro computers

System 2800.

- * S-100 bus.
- * Switch-selectable asynchronous baud rates between 110 and 9600 bits/second.
- * Vector-3 console chassis with 12-inch CRT (18"W x 12 1/2"H x 21"D).
- * Capacitance Keyboard 6 slot motherboard, and power supply.
- * Z-80 based single board computer with 1 serial port, 3 8 BIT parallel ports, 3 PROM slots, and

1K RAM. Flashwriter II. Video board, 64K dynamic memory board and disc controller. DUALSTOR enclosure with two 8-inch double density disc drives, total disc storage capacity 2.4 m bytes.

- * Version 4 extended systems monitor on PROM. Vector CP/M 2.2. SCOPE. Screen Oriented Program Editor, full screen dynamic simulating debugger, ZSM Z-80 assembler, Microsoft BASIC-80 Release 5.



System 3030.

- * Vector-3 console chassis with 12-inch CRT (18"W x 12 1/2"H x 21"D), capacitance keyboard, 6-slot S100 motherboard, and power supply.
- * ZCB Z-80 based single board computer with 1 serial port, 3 parallel ports, 3 PROM slots, and 1K RAM. Flashwriter II Video board, 64K dynamic memory board, floppy disc controller board, Winchester disc interface board, Megastor enclosure with 8-inch Winchester 3-platter hard disc drive, and

2 Micropolis Mod II quad density mini-floppy disc drives.

- * Capacity Hard Disc 32 M bytes.
- * 2 5 1/4" MICROP DISC DRIVES giving 630 Kbytes. Storage Capacity.

* Version 4 extended systems monitor on PROM. Vector CP/M 2.2. SCOPE. Screen Oriented Program Editor, full screen dynamic simulating debugger, ZSM Z-80 assembler, Microsoft BASIC-80 Release 5.



System 'B'

- * 64K Bank. Selectable Ram (56K available to user).
- * 3 Serial Ports, 2 Parallel Ports.
- * Twin Disc Drives, 630K Capacity.
- * Z-80 CPU, with Fast 4MHZ Clock.
- * Interrupt Handling on I/O Board.

- * 18 Slot Motherboard.
- * Vector Mindless Terminal.
- * Flashwriter II Video Board (24 x 80).
- * CP/M 2.2 Operating System.
- Plus Microsoft Version 5 BASIC. SCOPE Screen Oriented Program Editor, Full screen dynamic simulating debugger, ZSM Z-80 Assembler.



At Almarc Data Systems, when you buy Vector Graphic Micro-Computers, you are assured of Almarc's experience of over 430 systems installed throughout the U.K. - plus their back-up of full service facilities carried out by experienced staff.

Almarc are Specialists in Vector Graphic equipment which includes Micro-Computers for research, laboratory work,

word processing, business systems, schools, colleges, universities and industry. Plus an ever growing list of compatible software including Pascal, Fortran, Cobol, APL, Algol, Basic Compiler and others.

We will be pleased to demonstrate how Almarc + Vector Graphic Systems equates to The Complete Partnership in Micro-Computers.

• Circle No. 183

DATA SYSTEMS LTD

906 Woodborough Road, Nottingham NG3 5QS.
Tel: (0602) 625035

What happens during an interrupt

David Peckett looks at interrupts and their uses.

MANY COMPUTER systems have to respond immediately to unpredictable outside events. For instance, a computer running some form of chemical process may have to take emergency action if a reaction chamber overheats.

One could program the computer to poll external devices at regular intervals to see if they need attention; that approach could, however, introduce undesirable time delays and would represent a software penalty.

At other times, events may take place at regular intervals which are separated widely in terms of computer time. A 6502 might be programmed to accept an input from a paper tape reader, PTR, by a polling loop:

```
WAIT LDA STATUS;WAIT FOR MSB
BPL WAIT   ;... TO BE SET
LDA DATA ;READ DATA
STA (FILE),Y;FILE IT
INY       ;UPDATE POINTER
JMP WAIT  ;BACK FOR NEXT
          BYTE
```

The last four instructions handle the data and, together, take 15 μ Sec to complete. The PTR is unlikely to read

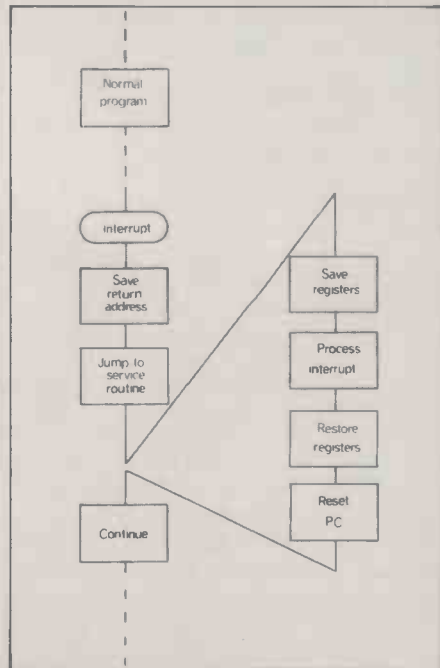

Figure 1. Interrupt handling.

more than 500 characters per second, i.e., one every 2,000 μ Sec. That means that the micro will spend 1,985 μ Sec in every 2,000 waiting for something to happen — 99.25 percent of its time. It would be much better if it could do something with that time, and only service the PTR when the latter demanded it.

Generally, interrupts are events which

can happen at any time and which demand an instant response — well, not exactly instant. Because an interrupt is not normally in phase with the system clock, it can occur — probably will occur — in the middle of an instruction's execution. It would be too complicated for the micro to drop what it was doing immediately and so it will respond when it finishes its current instruction. That is near enough to instant for most people.

Handling interrupts. When the interrupt occurs, the micro will jump to a defined point in memory where it expects to find the interrupt-service routine which handles the interrupt. At the end of it, the micro will jump back to the point where it was interrupted.

In some ways, an interrupt is like an unpredictable subroutine call. Like such a call, the micro must first save its program counter in the stack so that it can return at the end of the routine. The interrupt handler will also use some, if not all, of, the registers in the micro which will probably contain half-processed data. Those registers must not be corrupted — if they were, the return would be meaningless.

It is, therefore, normal for the micro to save all its internal registers in the stack during the interrupt, and restore them afterwards. Sometimes, as with the Motorola 6800, they are saved automatically, sometimes, e.g., the 6502 and Z-80, special code must be written. The register handling obviously adds a software overhead to the service routine. The basic form of an interrupt service routine is shown in figure 1.

Enabling interrupts. Sometimes, interrupts cannot be allowed to occur. For example, if the micro is busy taking in serial data when the interrupt occurs, it must not react. If it did, it would return from the interrupt to find that the data stream had moved on, and so the resumed program would process rubbish. At other times, an interrupt must be protected against disturbance.

It is, therefore, normal to give the programmer a way of controlling the response from the micro. It could be by setting a flag — e.g., the 6502s CLI and SEI instructions, or by controlling an internal flip-flop, e.g., the Z-80 EI and DI. If an interrupt occurs when the response is disabled, it will normally be serviced as soon as the block is removed.

In certain circumstances, the interrupt must be handled immediately — for instance, the micro may have to respond

(continued on next page)

Change your
Superboard
or UK101
into a
real machine

Two add-ons
from Mutek

CEGMON

The new monitor for all OSI and UK101 systems, with the *right* range of features!

- ★ Twin-cursor screen editor ★
- ★ Improved keyboard routine ★
- ★ New screen-handler ★
- with fully programmable protected areas, screen and 'window'-clear, cursor controls
- ★ New machine-code monitor ★
- with load/save, tabular display, 'modify' entry for text and hexadecimal, breakpoint handler, block move, and much more
- ★ Disc bootstrap ★
- ★ Full compatibility ★

Complete with full manual and card
price £29.50

48×32 VIDEO CONVERSION

Converts Superboard, C1 or UK101 display to 32 lines of 48 characters. Also converts system clock to 2MHz — halves program run times! Compatible with CEGMON monitor Available as Mutek upgrade or kit

Superboard/C1: upgrade £40, kit £40
UK101: upgrade £34, kit £16

All prices quoted exclude VAT

MUTEK Quarry Hill, Box, Wilts
Tel: Bath (0225) 743289

• Circle No. 184

The Dream Machine

Fantasy, fact and fiction
with the
COMPUCOLOR II
Micro system with 64 colour combinations
Prices from £1200 with micro floppy

COPERNICUS (0428) 52888
7 Way Hill, Haslemere, Surrey.

• Circle No. 185

LOOK

The latest version of the famous
EPSON TX-80
The TOPPER with GRAFTRAX



This unique option from DATAPLUS gives the TX-80 a FULL HI-DEF GRAPHICS capability. When the bit plot mode is invoked, each bit arriving via the parallel interface individually controls one of the 7 print head needles. Additional facilities include software control of line feeds in .007" increments, and many others. You have NEVER been offered a better deal than this.

TX-80 with parallel interface..... £355 + VAT
GRAFTRAX option..... £4.50 + VAT
Apple, PET, Sharp, Tandy
RS.232 Interfaces..... £ 40 + VAT
Cash or Credit Cards accepted.

DATAPLUS LTD.
39-49 Roman Road, Cheltenham,
0242-30030 or 37373.

• Circle No. 186

Verbatim



TOP QUALITY FLOPPIES

Single Side Single Density Diskettes	All Inclusive Unit Price	Price per Box
8"	£2.42	£29.55
5 1/4"	£1.83	£22.77

Sold in Boxes of 10

Always Quote Your Machine Type When Ordering

- Many other Types Available
- We Can Quote for Your Machine
- Quantity Discount For 50 +
- Please Give Us A Ring

GRAM
BUSINESS SYSTEMS

48 HEDLEY STREET,
MAIDSTONE, KENT ME14 5AD
TEL: MAIDSTONE 679595
MAIL ORDER ONLY

• Circle No. 187

(continued from previous page)

to a power failure before the V_{cc} rail drops too low — about 2mSec. Both our micros have to interrupt input pins; a non-maskable interrupt — NMI — which will always obtain a response, and an interrupt request — IRQ — which is the normal, maskable, input.

Identification of interrupts. Interrupts from a single device are easy to understand, but what happens if several devices, e.g., cassette recorder, PTR, keyboard, external instruments — are all connected to the same interrupt pin? — figure 2. How does the micro know which one needs service? It has two options; polling and vectoring.

The polling approach is more easily understood but more expensive, in terms of software, to implement. The micro has to look at the status of each device to see which one called it — it can then jump to an appropriate routine — figure 3.

Vectoring is a more elegant and faster-responding approach. As well as setting the interrupt line, the peripheral also forces a byte on to the data bus. The micro reads that byte, and uses it to generate the address of either the start of that peripheral's service routine, or a pointer to the start.

There is obviously a danger that the word forced on to the bus could interfere with the instruction being processed when the interrupt occurs. To prevent that happening, the micro sets an output signal when it starts the service routine. That signal is used to gate the byte on to the data bus — figure 4.

Priority of interrupts. If a micro can be interrupted by several devices, Murphy's Law decrees that two or more will demand attention at the same time. The micro then has to decide which one to handle first. Even more complex, there may be a system of interrupt priorities by which vital interrupts can stop lesser service routines, but not the other way round.

Like so many other aspects of micro-computer design, two basic approaches are possible. The problem can be tackled by software, or it can be tackled by hardware. There is the usual trade-off between the two — software is cheap but

slow, hardware is expensive but fast.

A software-based priority system is very simple, and uses polling. The micro polls the peripherals in descending order of importance and services the first one it encounters. If that approach is used, the interrupts must be disabled all the way through the handler. That is because the interrupt line will remain active during the high-priority service, but should be responded to only at the end.

A weakness of the polling technique is that it cannot cope with high-priority interrupts of low-priority events. That is because the response from the micro is disabled during the service routine.

The simplest form of hardware-based priority scheme relies on a special priority interrupt control — PIC — chip, such as an Intel 8214. That can control, typically, eight peripherals, which are assigned

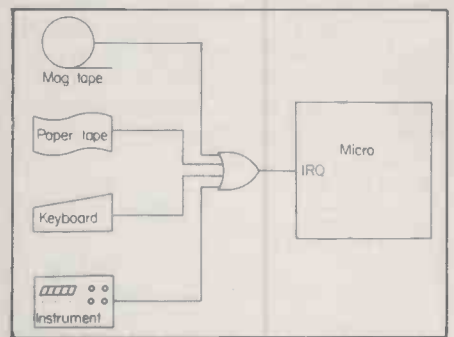

Figure 2. Multiple interrupts.

fixed priorities by the PIC pins they are wired to — figure 5. Whenever an interrupt occurs, the PIC routes it to the micro, together with a data byte defining which peripheral has interrupted.

The micro can use that byte with vectored interrupts. The PIC also holds back low-priority interrupts until more important ones are finished, but will allow a high-priority one through on top of a low one. It thus gives all the basic interrupt control we might want.

An alternative to a PIC is a daisy-chain. That approach strings several individual device controllers, e.g., PI/Os, together in series — figure 6. The controller nearest the CPU has the highest priority. If it does not need service, it will pass on requests from lower in the chain. However, if it has called for an interrupt, it will block lower requests while it is serviced.

The system can be used with vectored interrupts — the vector is passed up the chain just like the control signals. Obviously, it allows high-priority to interrupt low-priority and, in general, gives similar facilities to a PIC. It has the advantage, however, of using the standard peripheral chips, rather than extra hardware. It can also be extended to any number of devices, rather than being limited to the eight of a PIC.

The 6502 has provision for both non-maskable — NMI — and maskable — IRQ — interrupts. It has an almost identical response to both, and does nothing until it has finished its current

Figure 3. Interrupt polling.

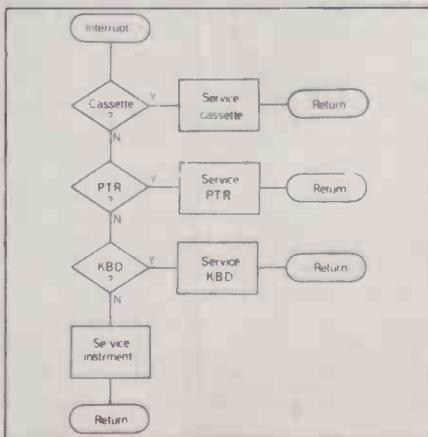

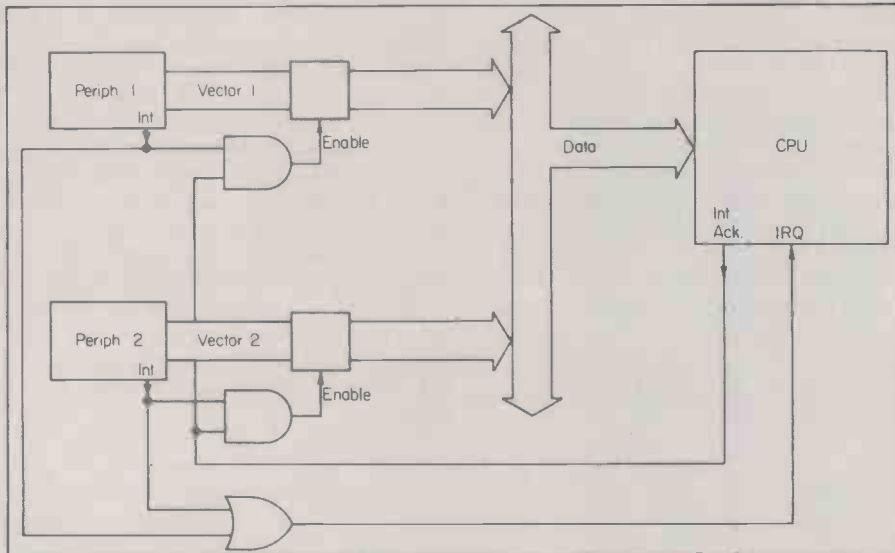

Figure 4. Vectored interrupts.

instruction. It then starts to service the interrupt.

Initially, the contents of the PC — which shows the instruction the micro was going to perform next — are saved on the stack to give a return address; the PSW is also pushed on to the stack. The PSW must be saved because virtually any operation would corrupt the flags.

The micro then sets the "I" flag in the PSW to "1". That stops responses to further IRQs until the programmer allows them. The 6502 cannot be interrupted while it is entering the service routine.

Finally, the micro loads the contents of addresses FFFE and FFFF₁₆ — for an IRQ — or addresses FFFA₁₆ and FFFB₁₆ — NMI — into the program counter. The data at those two locations act as vectors to the two service routines.

The routine does whatever is necessary and ends with the special instruction "RTI" — ReTurn from Interrupt — that pulls the saved PSW from the stack, incidentally setting I back to its original value, and then recovers the return address into the PC. The micro then returns automatically to where it left off.

The 6502 does not do anything with A, X or Y during interrupts. In practice, of course, the handler would almost certainly use A, and probably X and Y also. The start of the service routine should therefore save those registers, which can be recovered at the end:

```

;START OF INTERRUPT SERVICE
ROUTINE
PHA      ;SAVE A
TXA
PHA      ;SAVE X
TYA
PHA      ;SAVE Y
.
.
;SERVICE ROUTINE PROPER
.
.
PLA
TAY      ;RESTORE Y
    
```

```

PLA
TAX      ;RESTORE X
PLA
RTI      ;RETURN
    
```

That puts a five-instruction penalty at each end of the service routine, but it is unavoidable if the micro is to pick-up properly at the end. You will recall that the I flag was set at the entry to the interrupt handler. That is fine if you do not want to be interrupted. Often, though an interrupt can itself be interrupted. It is up to the programmer to allow for that via the "CLI" command. Equally, if the main program must not be interrupted for any reason, you should use "SEI".

As its name implies, the NMI response cannot be blocked by I, but will be actioned whenever it happens. For that reason, it is normally reserved for emergencies, such as power failures, which cannot tolerate any delay.

Because the 6502 uses the data in two addresses as vectors to the interrupt routines, the programmer must ensure

(continued on next page)

Figure 5. Use of PIC.

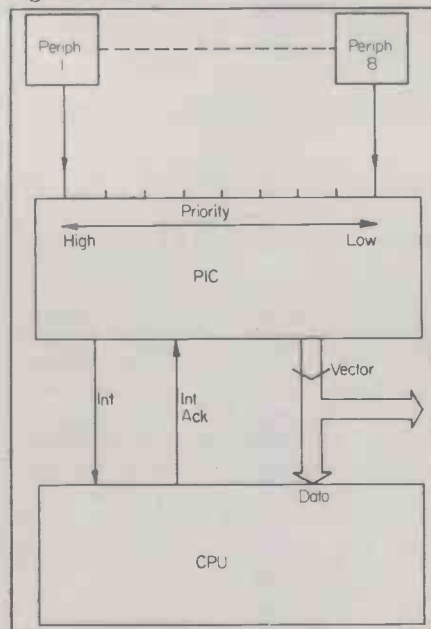

SPECIALS for PET

- Programmer's Toolkit £39
 - Light Pen (+ Software) £25
 - Word Processor (M/Code) £35
 - Music System Complete £37
 - Adventures 1 & 2 each £ 7
- (ALL + VAT BUT INCL. POSTAGE)
Send for details — state model

SIMPLE SOFTWARE LTD
15 HAVELOCK ROAD
BRIGHTON, SUSSEX BN1 6GL
(0273) 504879



• Circle No. 188

MICROCASE "turns a

board into a real computer"

- For NASCOM 2
 - COMPUKIT
 - SUPERBOARD
 - ALSO UNCUT FOR NASCOM 1 ETC.
- Direct from us or from your dealer —
but make sure you see a
GENUINE MICROCASE
about £30

SIMPLE SOFTWARE LTD
15 HAVELOCK ROAD
BRIGHTON, SUSSEX BN1 6GL
(0273) 504879

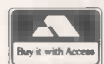

• Circle No. 189

NEW Get your Programs up & running FAST For Only £3-10 inc. p&p

Send now for the very latest easy to use, multi-rule/flowchart template—for the fast design of program/system logic diagrams. Complete with special 'Clearview' window to make Printout checking and reading fast and accurate every time! Built in dual rule, calibrated in both 1/10 of an inch and millimetres—absolutely invaluable!

You'll wonder how you managed without one!

HURRY WHILST STOCKS LAST! Send cheques/PO. now to:

- Executive Office Products
- Dept. No. A/2
- 292 Hale Road, Hale Barns.
- Altrincham, Cheshire WA15 8ST.

• Circle No. 190

BROKEN COMPUTERS MENDED

Fast reliable service by professional computer engineers. All models catered for.

For further details please contact:
BYRD ASSOCIATES on Bedford (0234) 214785 (24 hour answering service) or write to us at 43 Ashburnham Road, Bedford.

• Circle No. 191

LINCOLNSHIRE APPLE DISTRIBUTORS

Stocks of Apples and most accessories Texas, Qume & Paper Tiger Printers 8" Discs, Corvus Disks for Apples.

SOFTWARE

Financial Planning Databases Mailing Visicalc Accounts Word Processing. Also the well known "Estate Computer Systems" Estate Agents Package in use throughout the U.K.

ESTATE COMPUTER SYSTEMS
30 Carre St., Sleaford, Lincs.
Tel: (0529-305637)

• Circle No. 192



for



Lots of **11Z-80Ks** and **PC1211s** for **IMMEDIATE** delivery. We try to match best prices anywhere!!!

King Pin Computers

PO BOX 40 — STEVENAGE —
HERTS SG1 2NA
TEL: STEVENAGE (0438) 59677

• Circle No. 193

topmark computers

NEW! NEW!
FORTRAN
(needs language card)

Send only £120 + VAT £18 (Fortran only)
or £419 + VAT £62.85
(complete system, includes Pascal and language card)

NEW! NEW! NEW!

NEW! **DOS 3.3** — much improved capacity £40 + VAT £6

NEW! **Eurocolour card** — vastly superior to previous version £113 + VAT £16.95

Official Government and Educational orders accepted.

Contact Tom Piercy at
Topmark Computers, 77 Wilkinson Close,
Eaton Socon, St Neots, Cambs. PE19
3HJ Huntingdon (0480) 212563

• Circle No. 194

(continued from previous page)

that the proper start points are loaded into the top of memory. If that is not done, interrupts will not be handled. The 6502 technique means that any interrupt-using system must have RAM at the very bottom of memory — for page-0 and the stack — and RAM or ROM at the very top; something is also needed between.

Break. There is only one more 6502 instruction which we have not covered in

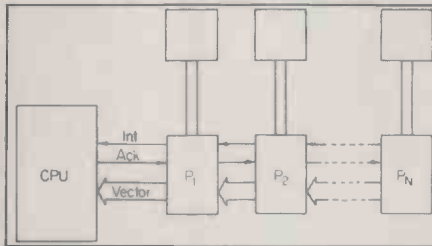

Figure 6. Daisy-chain.

the series — “BRK” BReAK. It acts as a software interrupt and, like an IRQ, saves the program counter and PSW, and then vectors to the address held in FFFE/F. BRK is normally used as a patch in software proving, and is intended to replace multi-byte instructions. You must be careful when you use it, because it saves (PC+2) in the stack and not program counter. That may sometimes cause problems with the RTI.

When a monitor program inserts breakpoints in a program, it does so via BRKs. The interrupt routine then puts the registers, etc., somewhere where they can be examined, and gives the normal facilities to the poor soul who is trying to debug the software. How does the interrupt service routine tell the difference between an IRQ and a BRK? They use the same vector.

The PSW saved in the stack after a BRK has its “B” flag set to “1”; the PSW left in the micro is unchanged. You can then test the flag in the stack to see just what has happened:

```

;START OF INTERRUPT SERVICE ROUTINE
PHA          ;SAVE A
TXA
PHA          ;SAVE X
TYA
PHA          ;SAVE Y
TSX          ;X = SP
LDA $104,X  ;READ PSW FROM STACK
AND #%00010000 ;TEST B FLAG
BNE BREAK  ;BREAK ROUTINE?
;ORDINARY INTERRUPT — CONTINUE
    
```

The interrupt service routine must, first, save the registers. The PSW is then read out of the stack via an indexed “LDA”; the base address recognises that the stack is on page-1, three more items have been added to it since the PSW was pushed on, and the SP points to the next empty space. That technique avoids disturbing the stack or the SP. Once the stacked PSW is in A, it is easy to check and respond to the B flag.

The Z-80 can respond to IRQs in any one of three ways, termed interrupt modes

0, 1 and 2. The three modes can be selected via the three instructions “IMO”, “IM1” and “IM2” alternatively, when the micro is re-set, it goes automatically into mode 0.

Interrupt mode 0. Mode 0 is identical to the only 8080A maskable interrupt mode. When the interrupt occurs, the external device must set not only the IRQ line, but also has to force a single byte on to the data bus. The Z-80 finishes its task, takes the byte, and interprets it as an instruction. At that point, nothing has been pushed to the stack, but the response from the micro to further interrupts has been disabled.

In theory, any single-byte instruction could be forced on to the data bus, but, in practice, it will inevitably be one of the eight “RST p” commands. Those commands are effectively single-byte subroutine calls to eight possible page-0 addresses; the particular address is indicated by the “p”. Like ordinary “CALL”s, they save the program counter in the stack, and load the start address of the routine into the program counter.

Each of the eight “RST”s will cause a jump to a block of memory only eight bytes long — figure 7. Obviously, no sensible service routine can be put in that space, and so each block will normally contain only a jump to another point in memory where the real service routine lies. Interrupt mode 0 thus effectively gives eight vectored interrupts, with the pointer

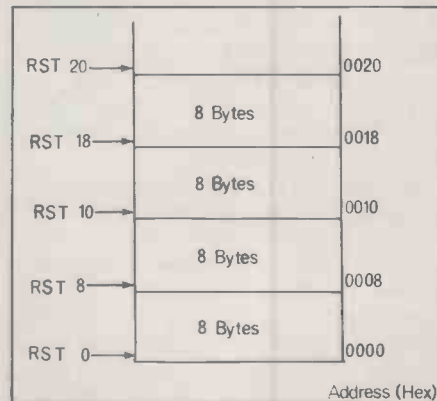

Figure 7. Mode 0 Interrupts.

supplied by the peripheral defining the location of a vector to the service routine.

Since nothing but the program counter goes into the stack automatically, the handler's first actions must be to save the environment by pushing all the Z-80 registers on to the stack. They can be recovered at the end of the routine. The last instruction in a mode 0 interrupt service routine must be “RETI”. That acts as a normal subroutine “RET”, but also sets internal flags to tell the micro that the interrupt is over. It does not re-enable interrupts, and so the programmer must do that explicitly with an “EI” at whatever point is appropriate.

The total software overhead of a mode 0 interrupt is shown in figure 8, which illustrates a “RST 30” operation. The

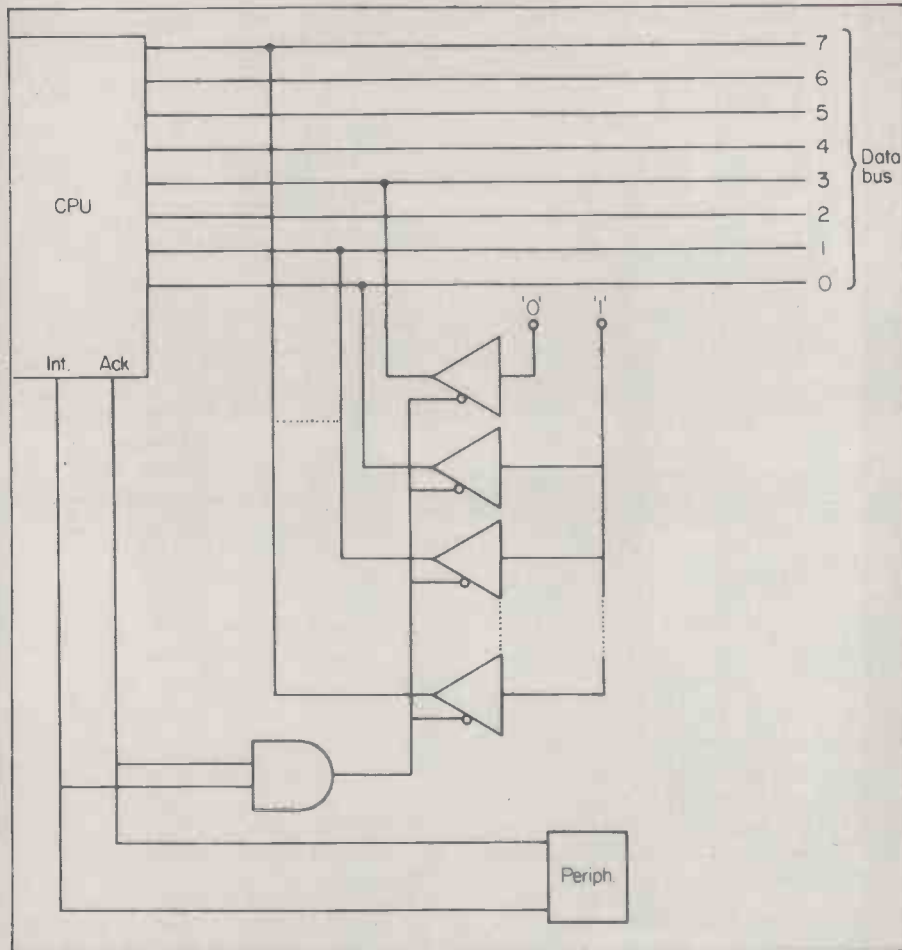

Figure 9. Hard-wired 'RST30'.

code for the RST p, e.g., RST 30 = 1111 0111, can derive from two main sources. Either it can be applied directly from the interrupting device, e.g., from a Z-80 PI/O vector address register, or it can be applied to the data bus by a suitable gating system — figure 9.

Although the RST instructions are primarily intended for use with interrupts, you can use them at other times. If your system does not use interrupts, or uses only a few, you could use them perfectly well as normal subroutine calls. In particular, if space is tight, the availability of single-byte calls could make all the difference.

Figure 8.

```

;Z80 INTERRUPT-HANDLING SOFTWARE OVERHEAD
;THE NEXT INSTRUCTION IS AT 0030H
;
JP LNT30 ;GO TO INTERRUPT ROUTINE
;
;THE NEXT INSTRUCTION IS WHEREVER IN
;MEMORY IS CONVENIENT
INT30 PUSH AF
      PUSH BC
      PUSH DE ;SAVE THE
      PUSH HL ;..REGISTERS
;
;ACTUAL SERVICE ROUTINE
;
POP HL
POP DE
POP BC ;RESTORE THE
POP AF ;..REGISTERS
EI ;ENABLE INTERRUPTS
RETI ;RETURN FROM INTERRUPT
;
;THE "RETI" PULLS OUT THE PC SAVED
;WHEN THE INTERRUPT OCCURRED
    
```

Interrupt mode 1. If the Z-80 has been set to mode 1 by the "IM1" command, its interrupt response is similar to that of the 6502. When the interrupt occurs, the system performs an automatic "RST 38".

From that point, the response is identical to a mode 0 response in which "RST 38" was jammed on to the data bus. The value of that mode is that it does not need external devices to force anything on to the data bus; the micro response is entirely self-contained. Indeed, it ignores anything which might be on the bus at the time.

On the other hand, there cannot be any vectoring direct to the routines for specific peripherals. If several devices could force a mode 1 interrupt, the Z-80 must poll them, just as the 6502 had to.

Mode 1 is normally used with very simple systems in which only one external device is likely send an interrupt.

Interrupt mode 2. This mode, selected by "IM2", is by far the most powerful of the three Z-80 maskable interrupt modes. It makes provision for no less than 128 different vectored interrupts, which should be more than adequate for the most complex system.

Whenever a mode 2 interrupt occurs, it is acknowledged in the usual way, further interrupts are disabled, and the interrupting device jams a single byte on to the data bus. The micro takes the byte, and uses it

(continued on next page)



Modata

Digital Microsystems

OVERPRICED COMPUTERS INADEQUATE PERSONAL MICROS?

Modata supply Dealers and OEMs with Digital Microsystems competitively priced Single and Multi-User computers which include Reliable Floppy and Hard Disk storage.

ie. DSC-2: Z80 at 4MHz + 64Kb + 2 x SSDD 8" Floppies for 1Mb + CP/M - £3525 E.U.

**WHY NOT FINDOUT MORE?
0892 41555**

Modata Ltd. 30 St. Johns Road, Tunbridge Wells, Kent TN4 9NT

• Circle No. 195

AT LAST FUNCTIONAL TRS 80 BUSINESS PROGRAMES 16K.LII

for cassette
"Most Impressive" is the report of users. In use by many businesses & University Authorities.

Some Examples
BANK A/C PROGRAMME
22 Column analysis, self totaling on all columns. Keeps full alpha & numeric records. At command shows 17 monthly & yearly Totals to date, including Partners drawings, Total O'heads etc. £21.95

Sales Ledger
Full record up to 17 entries for each invoice. Totals 8 columns, searches & totals individual accounts at will, also weeks sales, months individual heading totals, agents sales & displays entire records page by page. £21.95

MAILING LIST
Searches by Name, Town, County & code no. which can be used to create your own reference system. Search by name Does Not Require Exact Spelling To Find. £9.95
All programs are menu driven needing no operator expertise. Most responses require only single keystrokes. Operator errors are correctable. Custom Software.
NEW! New range of terrific animated Games, Not Imported. P&P Inclusive.
ACCESS COMPUTERS 2 Rose Yard, Maidstone, Kent ME14 1HN. Tel: Maid. (0622) 58356

• Circle No. 196

PIECE-WORK TRS-80

- 100 COST CENTRE CODES
- 400 EMPLOYEES
- 1650 TRANSACTIONS
- 5 MANAGEMENT REPORTS
- £390 + VAT

CLIVE TAYLOR
TAYLOR MICRO SYSTEMS LTD.
HAMSTEAD IND. ESTATE,
OLD WASALL RD.,
BIRMINGHAM B42 1DF
021-358 2436

• Circle No. 197

IBM GOLFBALL PRINTERS From £425 + VAT



Reconditioned printers with keyboard and RS232 interface.

Sales — Service — Supplies

AID Office Supplies
Brindwell Ltd.,
Frampton Cotterell
BRISTOL

Telephone: Winterbourne (0454) 774564

• Circle No. 198

Inexpensive desks to suit your computer system

Data Efficiency Ltd introduced the following new desks to their already well established range. These new desks are well designed, practical, yet inexpensive—ideal for many computer systems.

Quick Assembly VDU Desk

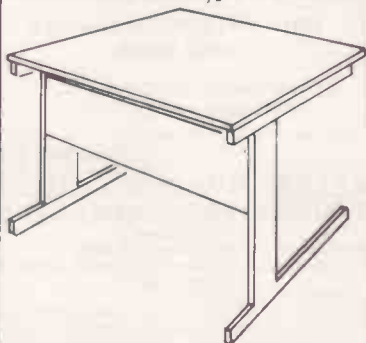

An attractive yet inexpensive VDU desk which may be assembled in minutes with the minimum of tools. Finished in honey beige paintwork with a Sumatra Teak Laminate work surface.

Available in two sizes:

PVDD/QA1—£38.00
(29 3/4 in. wide, 29 3/4 in. deep, 28 in. high)

PVDD/QA2—£49.50
(29 3/4 in. wide, 42 in. deep, 28 in. high)

Carriage and packing for the above are extra:—
London and the Home Counties—£7.00
Rest of the U.K.—£12.00

Micro System Desk

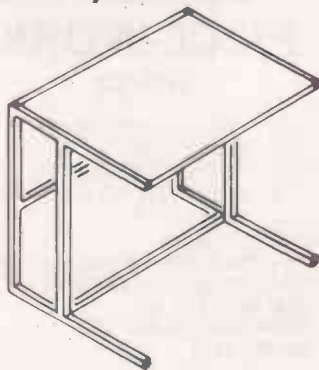

Although designed with the Apple Computer System in mind, this unit is ideal for many other systems. The desk is fitted with a cream melamine worktop and finished in a semi-gloss black paint. The desk measures 34 in. wide, 25 in. deep, 28 in. high and costs **£48.00**.

Optional Extras

For the PAPP5 include a Printer Stand and a Shelf Unit.

Carriage and packing for the Apple range will be charged at cost.
Prices quoted do not include VAT.

If you wish to buy any of the above desks, or require further details, please contact:

DE The Sales Office
Data Efficiency Limited
Maxted Road, Maylands
Avenue, Hemel Hempstead,
Herts HP2 7LE

Telephone: (0442) 57137/8/9
Telex: 825554 DATEFF G

• Circle No. 199

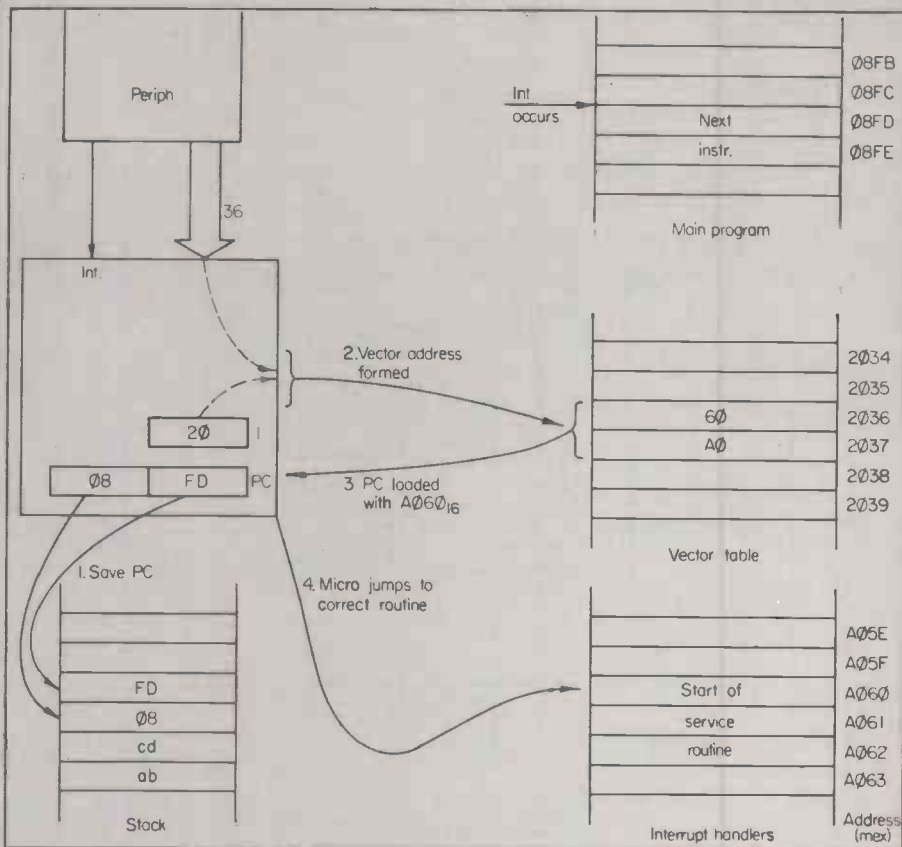

Figure 10. Mode 2 interrupt.

(continued from previous page)

as the lower byte of an address; the upper byte is defined by the contents of the Z-80 "I" register.

Together, the two bytes form a pointer to a location in a vector table somewhere in memory. The contents of the program counter are pushed on to the stack, and the 16-bit vector pointed to is loaded into the program counter. The micro jumps to a new address, which is the start of the interrupt service routine for whatever peripheral sent the interrupt in the first place. The whole process is shown in figure 10.

Once the correct service routine has started, then the system continues just as in the other two modes. The registers must be saved, the interrupt handled, the registers restored, and interrupts re-enabled. Finally, an "RETI" pulls the interrupted program counter off the stack to force the micro back to where it was interrupted.

The great value of that approach is that many peripherals can be handled, without wasting time identifying the source of an interrupt. The interrupt identifies itself and forces the micro to the right service routine.

The Z-80 peripheral chips such as the PI/O are designed to be used with this interrupt mode. We saw last month that, like the other Z-80 peripherals, the PI/O contains a vector address register — VAR — for each channel. If the device is to be used with mode 2 interrupts, the VAR is first loaded by writing to that channel's control port a vector control word. This

has the format: xxxx xxx0 the peripheral chip's logic recognises the "0" in the LSB position, and routes the entire byte into the VAR.

Whenever the chip initiates an interrupt, the contents of the VAR are put on to the data bus to form the lower byte of the vector address. Because the LSB is always zero, a maximum of 128 bytes can be generated (00₁₆ - FE₁₆). Stepping in twos allows each entry in the vector table the two bytes it needs to hold a 16-bit pointer.

Normally, each peripheral port will send a vector, thus identifying itself. The address can be anything, but it is normal to use a methodical system whereby port "n" has vector "2xn". That also ties in with the Zilog approach of giving each data port a separate control port; since the micro can address 256 I/O ports, we can have 128 control ports and 128 data ports.

For a system using five data ports — 0-4 — in conjunction with mode 2 interrupts, that could give the interrupt vector table of figure 11. The "I" register is assumed to contain 80₁₆. Using that allocation, the interrupt routine for port 0 starts at address A000₁₆, and both port 1 and port 3 are served by a routine starting at A090₁₆. Perhaps these two ports are both temperature sensors.

The vectored interrupt system is also well suited to a daisy-chain control system, particularly when using Zilog-type peripheral chips. The chain passes automatically through the correct vector for any given peripheral, and takes care of any priority problems.

TANDY COMPUTER CENTER

— FOR BUSINESS AND PLEASURE —
FULL RANGE OF TRS 80 COMPUTERS
DISC DRIVES, SOFTWARE, PRINTERS.
OTHER MAKES ALSO AVAILABLE



EXPERT FRIENDLY ADVICE



PJ

EQUIPMENT
3 BRIDGE STREET (0483)
GUILDFORD, SURREY 504801

• Circle No. 204

DISKWISE



THE Apple Agents
in Devon & Cornwall
Present
Quality Software direct or from your
local Apple Dealer.

HOTEL PLAN — Hotel Management system
inc. booking & guest billing £475
TV RENTAL MANAGEMENT £395

TRADE ENQUIRIES WELCOME

DISKWISE

25 Fore St., Callington, Cornwall
Tel. 05793 3780



• Circle No. 205

WHEEEE—BANK—POP NEW SOUND BOARD FOR MOST COMPUTERS.

SOUND BOARD £40 BUILT £35 KIT
TUNES—CHORDS & EFFECTS—FULLY
PROGRAMMABLE
CONNECTS TO 10 BITS OF ANY I/O PORT
LOUDSPEAKER, AMP & BATTERY
INCLUDED.
CASED + £3
(USES AY-3-8910)

JOYSTICKS £15 PER PAIR (BUILT)
CASED & COMPLETE WITH 2 PUSH
SWITCHES & 1 METRE OF CABLE PER UNIT
PAIR OF 2 AXIS JOYSTICKS CONNECTS
DIRECT TO MOST 8 BIT I/O PORTS.

**COMPUKIT/SUPERBOARD
OWNERS: I/O PORT £40 BUILT £35 KIT**
24 LINE I/O PORT COMPLETE WITH 2 8T28
BUFFER CHIPS AND ON BOARD RELAY.
PLUGS STRAIGHT IN TO 40 PIN EXPANSION
SKT.

LIGHT PEN £15 INC SOFTWARE
USES OUR I/O PORT. HARDWARE,
SOFTWARE & MANUAL SUPPLIED.
IK101 ONLY)

NASCOM OWNERS M/C CODE PGMS
KINESIS-SOUND BOARD OPERATING
SYSTEM. COMPOSE TUNES & PROVIDE
GRAPHICS. NEEDS 16K £15

BRICKS & TENNIS • 2 JOYSTICK GAMES •
USES OUR JOYSTICKS. £3.50
SPACE INVADERS & CATCH THE CRITTERS
£3.50

STATE MONITOR WHEN ORDERING.
ALL SOFTWARE ON TOP QUALITY
CASSETTE.

ALL PRICES INCLUDE VAT, P+P
ALL EX STOCK

HYSPEC
P.O. BOX 39,
LITTLEHAMPTON,
WEST SUSSEX BN17 6NZ

• Circle No. 206

BUYERS' GUIDE

The Buyers' Guide is a summary of low-cost computers available in this country. It appears every third month; we add new computers and amend existing information, as required, to keep it up-to-date. Systems are listed by manufacturer.

Microcomputers

ACORN COMPUTERS

Systems 1.2.3.: 6502-based, 1-8K RAM, COS or DOS, Hex or full keyboard, TV interface, Acorn bus. Personal or scientific use. Reviewed September 1979.

*From £65 for
System 1 kit; £285
for System 2 kit;
£670 for System 3
kit*

Atom: 6502, 2-12K RAM, up to 40K external memory, full keyboard, Basic in ROM, high-resolution graphics, cassette and TV interface, parallel port, I/O lines. Should eventually be able to link into a ring. Acorn Computers Ltd, 4a Market Hill, Cambridge CB2 3NJ (0223) 312772. Reviewed November 1980.

From £130

ALAN PEARMAN LTD

Maple: Z-80A, 16-64K RAM, S-100 bus, CP/M, 8in. discs, RS232 serial and parallel. Sold mainly as Micro-APL system. Alan Pearman Ltd, Maple House, Mortlake Crescent, Chester CH3 5UR. (0244) 46024.

From £1,510

ALPHA MICRO

AM-1010. AM-1051: WD-16, 64K-16MB RAM, S-100, four 8in. up to 90MB hard discs, RS232 up to 20 ports. Alpha Micro, 13 Brunswick Place, London N1 6ED. (01) 250 1616.

From £7,500

APPLE COMPUTERS

Apple II Plus: 6502, 16-48K RAM, 8K ROM, colour graphics, 5¼in. discs, general use. Own bus. Reviewed October 1979.

From £695

Apple III: 6502A with supporting chips, giving it a superset of 6502 instruction set. 96-128K RAM, colour graphics, integral 5¼in., RS232, four 50-pin expansion slots. Microsense, Finway House, Hemel Hempstead, Hertfordshire HP2 7PS. (0442) 48151.

P.O.A.



ATTACHE

Attache: 8080, 64K RAM, S-100, parallel port, 8in. discs, business system. Friargrove Systems Ltd, 494 Great West Road, Hounslow, Middlesex (01) 572 3784. *From £1,737 to £7,000*

BASF

System 7100: Z-80A, 64K RAM, RS232, 5¼in. discs, business systems. MPR, 293 Grays Inn Road, London WC2. (01) 837 6332. *From £4,937*

BILLINGS

BMS: Z-80A, 64K RAM, 8in. 200MB hard discs, business system. Mitech Data Systems, 8 Guildford Road, Woking, Surrey. (04862) 23131. *From £4,295*

B L MICROELECTRONICS

Biproc: Z-80 or TMS9980 kit, 1K RAM, 2K monitor, RS232, cassette, TV. BLM, 1 Willow Way, Loudwater, High Wycombe, Buckinghamshire HP11 1JR. (0494) 443073. *From £150*

BLEASDALE COMPUTER SYSTEMS

UDS: 8080, Z-80, 6809, 32K-1MB, Multibus, CP/M, 5¼in., 8in., hard, RS232, four parallel ports, IEEE 488, development system. Bleasdale Computer Systems, Francis House, Francis Street, London SW1. (01) 828 6661. *P.O.A.*

BRUTECH ELECTRONICS

BEM: Single-board processor with 6502 and no RAM. Data Precision Equipment, 81 Goldsworth Road, Woking, Surrey GU21 1LJ. (04862) 67420. *From £133*

BYTRONIX MICROCOMPUTERS

Megamicro: 8080/Z-80, 64K RAM, 8in. discs, CP/M. Business and university use. Bytronix, 83 West Street, Farnham, Surrey GU9 7EN. (0252) 726814. *From £6,080*

CANON BUSINESS MACHINES

Canon BX-1/BX-1d: 6800, 64K RAM, 5¼in. integral, RS232, V24 ports, business use. Canon Business Machines, Wadden House, Stafford Road, Croydon, Surrey. (01) 680 7700. *From £3,250*

COMMODORE BUSINESS MACHINES

Pet: 6502, 8-32K RAM, IEEE ports, integral 9in. screen, personal and general use. Reviewed August 1979. *From £460*

8000 Series - SuperPet: Upgrade of original Pet. 12in. screen, 5¼in. discs, business and general use. Reviewed October 1980. *From £895*

Kim-1: 6502, LED six-digit display, 1K RAM, cassette and Teletype interface, evaluation board for 6502 chip. Commodore Business Machines, 818 Leigh Road, Slough Industrial Estate, Slough, Berkshire. (75) 74111. Reviewed November 1978. *From £99.95*

Bug-byte MAIL ORDER SOFTWARE ALL PRICES INCLUSIVE

Sinclair ZX80 SOFTWARE

ZX80 PROGRAMMING COURSE: £7.50 inc. Book & cassette of programs explain with examples use of PEEK, POKE;USR, arrays, flowcharts etc.

ON HIGH QUALITY C12 CASSETTES. ONLY £3 per cassette INCLUSIVE

No1) Moon-landing; reaction-tester; hangman; codebreaker; intercept.

No2) Bio-rhythms; solitaire; battleships; dice.

No3) Remcard; bingo; sequences; letter-shuffle.

No4) Sine & cosine; simultaneous eqns; differentiation; circles; averages.

No5) Guess & gamble; number-sort; treasure hunt; fruit machine.

No6) Secret codes; horse race; stopwatch.

No7) Breakout; number puzzle; hex. loader.

More available; Send SAE & 12p stamp for catalogue.

Acorn Atom

SOFTWARE ON CASSETTE: ATOM BREAKOUT(4K) £4

PINBALL(6K) £6. All the following 4K programs are £3

each: PONTOON; BATTLESHIPS; ALIEN DESTROY; BIO-RHYTHMS; HORSE RACE; MINEFIELD.

BUG-BYTE: 251, Henley Road, Coventry CV2 1BX. **Circle No. 207**

EPROMPT ERASER



• CLEARS UP TO 32 CHIPS IN 30 MINS ON 200-250V A.C. •

• CONTINUOUS 253.7m BEAM. SAFE & SIMPLE. GUARANTEED •

• £39 C.W.O. £40 C.O.D. • P&P+VAT INCLUSIVE! •

TRADE ENQUIRIES INVITED FOR SUBSTANTIAL DISCOUNTS

ALL ORDERS AND ENQUIRIES POST-FREE TO:

TEX MICROSYSTEMS LTD.

FREEPOST, ST. ALBANS, HERTS. AL1 1BR

TRING 4797/ST. ALBANS 64077 ANYTIME

Circle No. 208

SUPERBRAIN SOFTWARE

Microsoft
 *BASIC Interpreter £175
 *BASIC-80 Compiler £210
 *FORTRAN-80 Compiler £270
 *COBOL-80 Compiler £390

Micropro
 *WORDSTAR £250
 *MAIL/MERGE £75
 *DATASTAR £195

Most items in stock
 2% discount for cash with order
 Dealer terms Available

Contact:
 THE MICRO SOLUTION LTD
 Park Farm House, Heythrop
 Chipping Norton, Oxon OX7 5TW
 Tel: (0608-3256)

Circle No. 209

APPLE & ITT2020 BUSINESS SOFTWARE

Professionally written packages now available with comprehensive manuals, built-in validity checks, interactive enquiry facilities, user options, satisfying accountancy, Inland Revenue and Customs & Excise requirements. On diskette under DOS 3.2. in Applesoft with SPACE utility. Not adaptations. Written for Apple System. Support all printer interfaces. Sales, Purchases and General Ledgers £295-00 each.

Manual only £3.

Payroll £375. Manual only £4.

General Ledger supports Incomplete Records, Job Costing, Branch and Consolidated Accounts etc.

General Ledger Applications Manual £10.

Prices exclusive of V.A.T. From our shop or your nearest stockist.

COMPUTECH SYSTEMS
 168, Finchley Road, London, N.W.3.
 Tel: 01-794 0202

Circle No. 210



avrohurst LTD.

- Systems Analysis & Programming
 - QUANTITY SURVEYING SYSTEMS
 - Payroll, Accounting & Invoicing
 - Hardware supplied if required
- Enquiries — tel or write*
Avrohurst Ltd. 186, Beehive Lane, Chelmsford CM2 96J
 tel: 354685

• Circle No. 211

EXIDY SORCERER

48K £849 + VAT
 32K NOW ONLY £799 + VAT

Dealer for

Bristol and South West

ELECTROPRINT (Mr. Tasker)

5 Kingsdown Parade • Bristol 6 • 292375

• Circle No. 212

LB ELECTRONICS

11 HERCIES ROAD, HILLINGDON, MIDDX.

T.M.S. 2516 (single rail) Full spec. £6.95p
 2708 (450ns) £3.00

Special Officer 2114 £1.85p

2526 Character generator with data £2.95.

SN 74116 60p, SN 74118 70p, SN 74194 50p,

SN 74198 75p, 74LS 240 £1.50, 74LS 245 £2.40,

74LS 266 75p, 74S260 40p, 710 (dill) 25p, 711 (dill) 30p,

2102 (650 NS) 48p, FND 500, 0.5 inch LED Display

(cc) full spec. 50p, 12 for £5.00.

HEADER PLUGS 16 way with cover 60p, 16 way

without cover 35p, 24 way without cover 95p

DIL switches, 4 way 75p, 7 way £1.00, 8 way £1.20,

10 way £1.40.

JUST ARRIVED IIT 2082.

1200 Baud data modern cc i ttv 24/rs 232c

Channel Centre frequencies 1300 and 1700 hz

(600 baud) or 1300 and 21hz (12 baud).

Synchronous or asynchronous operation over

2 or 4 wire switched or dedicated lines. Built in

test and Line test functions.

Brand new with manual £115 p/p £3.00.

All prices inclusive of VAT P/P on all components 30p.

Tel: UXBRIDGE 55399.

Access or Barclaycard Accepted.

• Circle No. 213

COMPUTER SUPPLIES (Swansea)

NEW
 MICRO SHOP
 NOW OPEN

PET + SUPERPET
 TRS I + II

APPLE + PRESTEL

Continuous Demonstration
 Competitive Quotations

**80/82 GOWER ROAD
 SKETTY, SWANSEA.
 Tel: (0792) 290047**

• Circle No. 214

COMPESHOP

UK101: 6502, 4-8K RAM, TV interface, RS232, full keyboard, single-board, personal use, similar to Ohio Superboard. Compshop, 14 Station Road, New Barnet, Hertfordshire EN5 1QW. (01) 441 2922. Reviewed May 1980.

From £199
 for kit

COMPUCOLOUR

Compucolour II: Z-80, 8-32K RAM, 5¼in. integral discs, 13in. colour VDU, RS232. General use. Dyad Developments. The Priory, Great Milton, Oxfordshire OX9 7PB. (08446) 729. Reviewed June 1979.

From £998

COMPUCORP

655-675: Z-80, 60K RAM own OS but will run CP/M with modifications, RS232, IEEE and others optional. 1-4 5¼in. discs, 16by80 VDU. Business use. Barnet House, 120 High Street, Edgware, Middlesex. (01) 952 7860.

From £2,595 to
 £4,750

COMPUTER CENTRE

Minikit: Z-80, 16K RAM, serial and parallel, 5¼in., CP/M, S-100.

From £800

Maxikit: Z-80, 16K RAM, serial and parallel, 8in., CP/M S-100. Computer Centre, 9 De la Beche Street, Swansea SA1 3EX.

From £911

COMPUTERMART LTD

Computermart 2000 range: Z-80A, single/multiple, 16-256K, CP/M, S-100 bus, graphics, 8in. single-density double-sided, 180MB hard disc, general/business use. Computermart, 60 St. Faiths Lane, Norwich, Norfolk. Norwich 615089.

From £6,000

COMPUTHINK

Act System 800: 6502, 48K RAM, full keyboard, graphics, 5¼ or 8in. discs, 12in. VDU integral. Business system. Act, 66-68 Hagley Road, Edgbaston, Birmingham B16 8PF. (021) 455 8686. Reviewed February 1980.

From £4,000

CROMEMCO

Single Card Computer: Z-80, S-100, 1K RAM, 20mA/RS232. OEM and industrial use.

From £273

Z2: Z-80, 31A power supply, motherboard, 21 sockets, serious hobbyist and OEM use. Reviewed February 1979.

From £573

Z2-H: Z-80A, 64-512K RAM, S-100 bus, CDOS, 10MB formatted fixed disc, two 5¼in. discs, hard discs up to 70MB.

From £5,373

System 2: Z-80A, 64-512K RAM, S-100 21 slots, CP/M, VDU, two 5¼in. discs, hard discs up to 70MB. Multi-channel interface available. General/business use.

From £2,095 to
 £6,408 for
 seven users

System 3: Z-80A, 64-512K RAM, S-100, CP/M, two or four 8in. discs, hard discs up to 70MB, general/business use. Datron Microcentre, 2 Abbeydale Road, Sheffield S7 1FD. (0742) 585490. Microcentre, 30 Dundas Street, Edinburgh EH3 6JN (031) 556 7354. Comart, PO Box 2, St Neots, Huntingdon, Cambridgeshire PE19 4NY. (0480) 215005.

From £3,568 to
 £8,304 for
 seven users



DATA APPLICATIONS

DAI Personal Computer: 8080, 8-48K RAM, colour graphics, 20 Eurocard industrial interface modules, RS232, industrial use. Data Applications, 168 Dyer Street, Cirencester, Gloucestershire GL7 2PF. (0285) 2588. *From £998*

DIGITAL DATA ELECTRONICS

SPC/1: 8085, 32-48K RAM, own OS, COMAL, Assembler and Pascal, graphics, up to three 5¼in. drives, up to four 8in. drives, 10MB Winchester, up to four 20MB cartridge, many ports. DDE, Clark House, Pump Lane, Hayes, Middlesex. 01-573 8991. *From £1,995*

DIGITAL MICRO SYSTEMS

DSC-3: Z-80, 64K RAM, CP/M, 8in. discs, hard discs up to 28MB, RS232/V24, business and general use. *From £3,445*

DSC-4: Z-80, 128-512K RAM, CP/M, 8in. discs, hard discs up to 28MB, RS232, RS422, business and general use. *From £3,995*

Hex-29: AMD 2900 16-bit, 64K-1,024K RAM, Hex bus, 8in. discs, hard discs up to 28MB. Eight to 32 ports, RS232. Modata, 30 St Johns Road, Tunbridge Wells, Kent TN4 9NT. (0892) 41555. *From £6,445*

DURANGO

F85: 8085, 64K RAM, own bus and OS, graphics, four RS232 ports, integral 9in. VDU, 9 x 9 printer, keyboard and two 5¼in. disc drives. General use. Comp Ancillaries, 64 High Street, Egham, Surrey. (07843) 6455. *From £7,500*

DYLE HOUSE

System 2000: Z-80, 64K RAM, dual 8in. discs, own OS, business use. Dyle House, 36 Abbot Way, Wellingborough, Northamptonshire. (0933) 79135. *P.O.A.*

DYNABYTE

DB8/1.2.4.5.6.7: Z-80, 32-64K RAM, S-100, CP/M, MP/M RS232, 5¼ or 8in. discs, hard discs up to 96MB, expands to multi-task/user system. Business use. Bill Miller, Dynabyte, 25 Park Road, Falsgrave, Scarborough, Yorkshire. (0723) 65559/73338. *From £1,600 to £12,000*

EACA

Video Genie EG3003: Z-80, 16-48K RAM, S-100, CP/M, 5¼in. discs, RS232, personal and general use. Lowe Electronics, Bentley Bridge, Chesterfield Road, Matlock, Derbyshire DE4 5LE. (0629) 2430. Reviewed February 1980. *From £369*

ECS MICROSYSTEMS INC

Aristocrat: Z-80A, 32-180K RAM, 12K PROM, dual 5¼in. drives, 946K. Three RS232 and one parallel port, CP/M, wide range of protocols, business and general use. Telecomputing Systems Ltd, Seacourt Tower, Westway, Oxford. (0865) 723621. *From £3,950*

NORTH STAR HORIZON TO 20% DISCOUNT

AND OTHER EQUIPMENT AT DISCOUNT PRICES

eg. 1 DRIVE DOUBLE DENSITY 32K	£1176
2 DRIVE DOUBLE DENSITY 32K	£1348
ADDITIONAL RAM — 16K	£208
ADDITIONAL RAM — 32K	£316
DECWRITER II LA36 60 CPS	£875
ELBIT DS 1920 VDU	£652
TELEVIDEO TV1 912 VDU	£476

(ALL EXCL VAT)

DCT MICROSERVE PHONE 025270 3091
LONDON AND SURREY TELEX 858508

• Circle No. 215

BIG EARS

SPEECH
INPUT
FOR
YOUR
COMPUTER!



BIG EARS opens the door to direct man-machine communication. The system comprises analogue frequency separation filters, preamps and signal conversion, together with a quality microphone and extensive software.

Words, in any language, are stored as "voice-prints" by simply repeating them a few times in "learn" mode. Using keyword selection techniques, large vocabularies can be constructed.

Use BIG EARS as a front end for any application: data enquiry, robot control, starwars — the possibilities are unlimited...

BUILT, TESTED & GUARANTEED £45
PRICE INCLUDES POSTAGE & PACKING. PLEASE ADD VAT AT 15%.
PLEASE STATE COMPUTER UK101, SUPERBOARD, NASCOM2, PET, TRS80, ETC.

MICROGRAPHICS
COLOUR CONVERSION FOR
UK101/NASCOM/SUPERBOARD
INCLUDES MODULATOR
KIT £45 BUILT £60

COLOUR
MODULATOR
RGB IN, PAL/
UH FOUR
KIT £12.00 BUILT £18.00

Please add vat @ 15% to all prices.
Barclaycard and Access orders accepted by telephone.

WILLIAM STUART SYSTEMS Ltd Dower House, Billericay Road, Herongate, Brentwood, Essex CM13 3SD. Telephone: Brentwood (02771) 810244

• Circle No. 216

SMALL SYSTEMS USERS YOU NEED OUR BOX

An attache-type teak finish case ideal for storing and using or transporting your computer system.

Featuring:

- Built in mains cable and plug.
- Built in mains outlet socket. (For VDU, TV Etc).
- Lift-off lid, Carrying handle, Rubber feet to base and one side, generous ventilation slots.

FIT YOUR SYSTEM ONCE ONLY

Then connect to mains supply and TV only for use. Internal dimensions: 32 x 21 x 5 inches. (EG Will accept Apple (or similar) plus 2 x FD plus Cassette plus Floppies plus Cassettes or any combination to suit you).

Sold unlined — You fit your system — or we will line it for you. Write with full details of your requirement for a quotation.

PRICE: £46.50 unlined. (Includes tax but add delivery at £5.95 by British Rail)

PHOENIX MANAGEMENT SERVICES. PARAGON HOUSE, 46, KENT HOUSE LANE, BECKENHAM, KENT. BR3 1LF. 01-659 7997.

Please allow 28 days for delivery.

DEALER ENQUIRIES WELCOME FOR ALL SYSTEMS

• Circle No. 217

Software for the PET (new ROMs), APPLE II (Applesoft), TRS-80 (Level II), SORCERER

All machines: Cash book £15; Discounted cash flow £8; Macro-economic game £5; Basic statistics £5; Regression £5; Chi-square (N x 1 equal and unequal expected) £5 ea.; T-test (correlated and independent samples) £5 ea.; Pearson correlation £5; ESP tester £5; PET only: TINY PASCAL £29; APPLE II only: Battleship commander (needs 32K) £11.95; SORCERER only: Smart terminal £28.95; Bedit £8.95; Starbase Hyperion £13.50; Martian Invaders £11.95; Recov £12.95; TRS-80 only: Temple of Asphal £16.95; Courtball £5.95; Hex loader £5; Books:— Supermap £7.95; The BOOK: Volume 1 £8.95; All programs require 16K RAM minimum and are cassette-based. Data preparation on cassettes for above machines at 85p per 1000 key depressions, £5 minimum charge. Send copy of data to be encoded, format required and cheque. For custom programs write with details of your requirements. When ordering please state machine configuration. Send orders and requests for catalogues to

Dept. C2 Sapphire Software Ltd.
PO Box 244
MILTON KEYNES MK14 7BQ

• Circle No. 218

SUPERBOARD II

STILL the best value in home computers. Just compare the features:

- 8K floating point BASIC in ROM
- Full ASCII keyboard
- Standard cassette/TV interface
- RS232 printer interface
- 4K user RAM
- Expandable to 32K and dual mini-floppy
- Full range of OHIO Computers carried.

AVAILABLE NOW FROM:

C.T.S.
31/33 Church Street
Littleborough

Lancs OL15 8DA
PLEASE RING OR WRITE FOR
LATEST PRICES

Tel: Littleborough (0706) 74342
or 79332 any time

• Circle No. 219

MEREFIELD'S ELECTRONICS LTD.

We specialise in memory products — LOW POWER SCHÖTTKY — T.T.L. — C-MOS etc.

Sales only, to MFGs and DSTBs (including retail shops).

Please note we have moved to new premises:

Merefields Electronics Ltd
White Horse Lane
Canterbury, Kent

Tel: 0227/64442/60604
Telex: 965386

• Circle No. 220

EQUINOX

200: Z-80, 64-512 RAM, S-100 bus, CP/M, Omnix, MicroCobol, MVT FAMOS, cartridge disc, six serial and one parallel port, business use. *From £7,500*

300: WD-16, 64-256K RAM, S-100 bus, CP/M, Omnix, MicroCobol, MVT FAMOS, cartridge disc drive, six serial ports, business use. *From £10,500*
Equinox, 16 Anning Street, New Inn Yard, London EC2A 3HB. (01) 729 4460/(01) 739 2387.

EUROCALC

Euroc: 8080, 64K RAM, 8in. discs, 15in. VDU, CP/M, business use. *From £8,000*
Eurocalc, 55/56 High Holborn, London WC1. (01) 405 3113.

EXIDY

Sorcerer: Z-80, 16-48K RAM, S-100, RS232, CP/M, 5¼in. discs. Plug-in ROM pack programs. Liveport, The Ivory Works, St Ives, Cornwall TR26 2HF. (0736) 798157. Reviewed May 1979. *From £749*

GNAT

System 10: Z-80, 65K RAM, own bus, CP/M, graphics, 5¼in. discs, RS232, RS449, 12in. VDU, full keyboard, optional IEEE. Business use. Millbank Computers, 98 Lower Richmond Road, London SW16. (01) 788 1083. Reviewed December 1980. *From £2,995*

HAYWOOD

Systems 1000-8000: Z-80, 32-65K RAM, 6000 is S-100, 3000 single-board, CP/M, graphics, 5¼in. discs, three serial and parallel ports. Business, scientific and general use. Haywood Electronics Assoc., 11 Station Approach, Northwood, Middlesex. (01) 428 9831. *From £2,359*

HEATH/ZENITH

H8: Single-board WH8 assembled, 8080, 16K-65K RAM. Heathbus nine slots, cassette interface, nine-digit LED. *From £321*

Z89: Z-80, 16-48K RAM, CP/M, integral 5¼ in. drive, optional dual external, two RS232, full keyboard, 12in. VDU. *From £1,570*

WH-11A: LSI-II, 16-bit, 16-32K RAM, own bus and OS, optional dual 8in. drives, serial and parallel ports. Heath Ltd, 11b Bristol Road, Gloucester GL2 6EE. (0452) 29451. (01) 636 7349. *From £1,250*

HEWART

6800Mk II: 6800 single-board, 1K monitor, 1K user RAM, 1K VDU RAM, 128byte scratchpad, education and home user. S-50 bus. *From £155*

6800S: 6800, 16K monitor, 8K Basic in ROM, graphics, 5¼in. drive. Hewart, 95 Blakelow Road, Macclesfield, Cheshire. (0625) 22030. *From £229*

HEWLETT-PACKARD

85A: 16-32K RAM, 32K ROM, IEEE 488, RS232, graphics, 5¼in. drives, integral 32 x 16 VDU, integral thermal printer, QWERTY and numeric keypad. Scientific use. Hewlett-Packard, King Street Lane, Winnersh, Workingham, Berkshire. (0734) 784774. *From £1,830*



IMAGE DATA PRODUCTS LTD

Image Data Eight: 6802, 4-40K RAM, 43-way bus, own OS, Basic assembler and editor, viewdata-style graphics, up to four 5¼in. discs, up to 12 RS232 ports. Image Data Products, 1-4 Portland Square, Bristol, BS2 8RR (0272) 40248. £500-£4,000

INDUSTRIAL MICROSYSTEMS

Series 5000: Z-80, 16-56K RAM, CP/M, S-100, two or three 5¼in. discs, two serial and one parallel port, desk unit, business and general use. From £1,500

Series 8000: Z-80, 64-256K RAM, S-100, CP/M, MicroCobol, MVT FAMOS, Omnix, two, three or four 8in. disc drives, two serial and one parallel port, desk unit, business and general use. Equinox, 16 Anning Street, New Inn Yard, London EC2A 3HB. (01) 739 2387/(01) 729 4460. From £2,500

INSTAR

Omega: 16-bit, 48-256K RAM, dual floppies, hard discs, up to 12 simultaneous users, business use. From £7,500

Asatayd: Z-80, 16-56K RAM, dual floppies, CP/M, S-100 bus, business use, Instar, 61 High Street, Croydon, Surrey CR0 1QD. (01) 680 5330. From £4,950

INTERTEC

Superbrain: Z-80, 64K RAM, 256 static RAM, dual Shugart, optional hard disc, CP/M, S-100 bus, business and general use. Encotel, Succombs Hill, Upper Warlingham, Surrey. (820) 5701. Sun, 138 Chalmers Way, North Feltham Trading Estate, North Feltham, Middlesex. (01) 751 6695. KGB, 88 High Street, Slough, Berkshire. (75) 38581. Icarus Computer Systems Ltd, 27 Greenwood Place, London NW5 1NN. 01-485 5574. Reviewed April 1980. From £1,495

ITHACA INTERSYSTEMS

Pascal Micro DPS1: Z-80, 64K-1MB RAM, full IEEE S-100 bus, CP/M version 2.2, graphics 8in. and hard discs, RS232, four parallel and two serial ports per S-100 board. Ithaca Intersystems, 58 Crouch Hall Road, London N8 8HG. (01) 341 2447. From £4,258

ITT

2020: Built under licence from Apple, expires at end of 1980. See entry under Apple II. ITT, Star House, Mutton Lane, Potters Bar. (77) 51177. From £827

KEMITRON ELECTRONICS

UDS 3000: Z-80, 1-64K RAM, Kbus, own OS, CP/M, 8in. and hard discs, ports up to 256. Kemitron Electronics, (0244) 21817. From £640 to £4,000

LOGABAX

LX-500: Z-80, 32K RAM, S-100, CP/M dual 5¼in. drives, business use. LogAbax Ltd., 1-7 Wesley Avenue, London NW10. (01) 965 0061. From £3,000

APPLE II/ITT 2020

VISCALC BACK-UP

A specially formatted Disk to enable you to take a back-up copy of your Visicalc Master Disk. Can also be used to store formats/worksheets £16.00

AUTO-INDEX

Master Catalog Program featuring fully automatic updating facility and comprehensive edit and search routines requires 48K and one Disk drive £18.00

DATABASE

Database System using specially formatted Disks and custom-written routines to give fast search and retrieval and offering similar facilities to systems costing around a hundred pounds. Introductory price £20.00

RELOCATED INTEGER

Enables any Investor Program to run without an Integer Card. Includes mini-assembler and now DOS 3.3 compatible. Specify memory size when ordering.

Cassette Systems £12.00 Disk Systems £14.00

*** TRADE ENQUIRIES INVITED ***

D. J. BOLTON

1 Branch Road, Park Street, St Albans
Tel: Park Street (0727) 72917

• Circle No. 221



THRIFTWOOD EDUCATIONAL SERVICES

THRIFTWOOD WILL SHORTLY BE OFFERING A 10-WEEK PART-TIME COURSE IN MICROCOMPUTER CONSTRUCTION, MACHINE ARCHITECTURE AND PROGRAMMING.

Participants will receive supervision in a workshop environment while constructing an expandable Z80A based machine with a minimum of 16K user RAM. They will also receive a planned course of study in programming.

The course fee is £625. This includes the cost of the machine, 60 hours tuition and V.A.T.

For further details please write to:

THRIFTWOOD
420, CRANBROOK ROAD
GANTS HILL
ILFORD
ESSEX

• Circle No. 222

DATALOG

1K - **ZX80** - integer

Programs - including: -
Printsketch, Nim, Mothership, Pharaohs Tomb, XOX (games), Addmax, Submax, Multimax, Divimax (decimals - 10 digit), Hotel (50 room bookings) Playmath (educational), Blorhythms (informative).

Supplied on cassette with full instructions and program description.

Please send large SAE for detailed list and a free program to: -

DATALOG (REF.Z1) 20 AYLEN RD,
PORTSMOUTH, PO3 5HB.

• Circle No. 223



in North Wales

with full Software Support for business and Professional use, including Invoicing, Ledgers, Stock Control, Word Processing, Hotel Systems, Petrol Station Management, Data Base, Mailing Lists and many other applications.



Dataforce (UK) Ltd.
42 Vale St, Denbigh
Tel (074571) 3636

* Apple is a trade mark of Apple Computer Inc. Cupertino C.A. USA

• Circle No. 224

Introducing
a whole new series
of games and utility packs
from £2.00

UK101-SUPER BOARD SOFTWARE

written any good programs?
COMPASS DESIGN LTD
call us on
Standish (0257) 426252

• Circle No. 225

Z X 8 0	SUPAPACK ALPHA: £4.95 (Kamikaze Alien, Duckshoot, Digital Clock, Docker + safe break)	S O F T W A R E
	SUPAPACK BETA: £4.95 (Cavemaster, Star-binder, Juggler, Bishop Berkely + Whirlpool)	
	SUPAPACK GAMMA: £4.95 (Liar, Centenary, Test, Traffic Jam, Cold Turkey, + Passive Resistance)	
	SUPAPACK DELTA: £4.95 (Aztec, Mind Control, Wild Eddy, Prison Break, + Ned Kelly)	
	Please make cheque/P.O. payable to: SYNTAX SOFTWARE DEPT PC1 96 COLLINWOOD GARDENS ILFORD ESSEX Allow 14 days for delivery	

• Circle No. 226

CONTROL TECHNOLOGY SUPERB ZX80 SOFTWARE

DATABASE80: you create size and names of your own files and process them — two examples

PATIENT	APPNT	BLD PRESS	PULSE
428	1230	171	90

FLT NO	DEST	DEPART	SEATSVAC
34	NYORK	1045	27

GATE80: has all logical functions and flip flops, as sub-routines, you build up circuit and find outputs to your inputs.

STAR80: GRAPHIC space game, blast your way to the stars.

£3.45 each; 2 @ £5.95; 3 @ £8.95

ALL FULLY DOCUMENTED

**CONTROL TECHNOLOGY, 39 GLOUCESTER RD
HYDE MANCHESTER, SK14 5JG**

• Circle No. 227

TRS 80 LIGHT PEN

THE PHOTOPOINT PACKAGE

INCLUDES:

- * A FULLY ASSEMBLED LIGHT PEN
 - * A CASSETTE OF FOUR PROGRAMS
 - * A 9V BATTERY
 - * FOUR PAGE INSTRUCTION BOOKLET
- CONNECTS TO YOUR LEVEL TWO TRS 80 VIA THE CASSETTE RECORDER AND REQUIRES ABSOLUTELY NO MODIFICATIONS TO YOUR SYSTEM. WORKS WITH ANY TV/MONITOR INCLUDING GREEN SCREEN. WORKS WITH VIDEO GENIE TOO!

— BUY THE BEST AT £14.99 + 30P P&P.

ESTRA PROGRAMS ON CASSETTE:
GEOGRAPHY TEST — £3.99
PEN AWARE — £1.99
DOTTO — £3.99

CSL MICRODATA:

4, GREENBARN WAY, BLACKROD,
LANCS, BL6 5TA. (0204 694265)

• Circle No. 228

LSI COMPUTERS

M-One: 8080, 8-16K RAM, own OS, dual Shugart 8in. drives, two serial and one parallel port, 12in. VDU and full keyboard. Business use.

From £5,995
with software
package

M2: 8085, 64K RAM and 4K EPROM. To be launched in December 1980. LSI Computers, Copse Road, St Johns, Woking, Surrey GU21 1SX. (04862) 23411.

P.O.A.

LUXOR

ABC 80: Z-80, 16-40K RAM, 12in. VDU, IEEE 488, RS232, 5¼in. drives, loudspeaker, personal and education use. CCS Microsales, 7 The Arcade, Letchworth, Hertfordshire ST6 3ET. (04626) 73301.

From £795

MICRO V

Microstar: 8085, 64K RAM, three RS232, serial inputs, StarDOS, twin 8in. drives, general use. Microsense, Finway Road, Hemel Hempstead, Hertfordshire HP2 7PS. (0442) 41191.

From £4,950

MICROMATION

Z-Plus: Z-80, 64K RAM, S-100 bus, CP/M (3), MP/M two serial and six parallel ports, business use. Rostronics, 115-117 Wandsworth High Street, London SW18 4HY. (01) 874 1171. Reviewed May 1980.

From £3,950 to
£8,550

MICRONEX

MX-100: Z-80A, 64K RAM, S-100 bus, RS232, CP/M, Pixel graphics display system, twin 8in. drives. Micronex, Harford Square, Bristol BS18 8RA. (027) 589 3042.

From £3,485

MIDWEST SCIENTIFIC INSTRUMENTS

MSI 6800: 6800, 16K-56K RAM, 5¼ or 8in. or hard discs up to 10MB. Systems 1,2,7 and 10. System 7 runs Flex, MSI, DOS and SDOS, RS232. System 10 is System 7 with hard disc. Business use. Strumech (SEED), Portland House, Coppice Side, Brownhills, Walsall, West Midlands. (279) 4321. Reviewed March 1980.

From £1,100 to
£12,000

MODULAR BUSINESS SYSTEMS

Tutor: 8085, 32-64K RAM, Intel Multibus, CP/M, optional graphics, twin 5¼in. drives or four 8in., two RS232 serial ports.

From £2,500

Elite: 8085, 32-256K RAM, Intel Multibus, CP/M, 5¼in. to 24MB hard discs, RS232, 24-bit TTL programmable port. Modular Business Systems, 21 Chappel Lane, Yeadon, Leeds LS19 7NX.

From £5,400 to
£25,000

NASCOM

Nascom 1: Z-80, 2-64K RAM, serial and up to 16 parallel ports, 8K Microsoft Basic, 1K monitor in EPROM. Personal use. Reviewed January 1979.

From £125

Nascom 2: Z-80, 1K RAM expandable to 256 with Nascom System 80 case. Nasbus, 8K Basic, 2K monitor and 2K character generator, low/high-resolution graphics and colour. 5¼in. single or twin floppy discs, RS232, parallel port, Kansas City cassette port. Nascom Microcomputers, 92 Broad Street, Chesham, Buckinghamshire. (02405) 75151. Reviewed April 1980.

From £295



NATIONAL MULTIPLEX

Pegasus: Z-80, 48K RAM, S-100 bus, 5¼in., 8in. drives, CP/M, 12in. VDU, business use. London Computer Store, 43 Grafton Way, London W1. (01) 388 5721. *From £2,700*

NEWBURY LABORATORIES

7768: CPU board, 4K RAM, cassette and VDU interface, up to 64K RAM, kit only. *From £45*

NewBrain: Z-80A, 2K static RAM plus 4K static or 16K dynamic, RS232 ports, 16-character, LED display, hand-held. Newbury Laboratories, King Street, Odiham, Hampshire. (025) 671 2910. *From £155 for model without LED*

NEWTRONICS

Elf II: Single-board on 1802, 256bytes to 64K RAM, Hex keypad, RS232 I/O and VDU interface, option keyboard, machine code or Tiny Basic, educational. *From £39 for kit*

Explorer 85: 8085, 4-64K RAM, S-100 bus, RS232, VDU interface, 8080 and Z-80 software, hobbyists and OEM use. Newtronics, 255 Archway Road, London N6. (01) 348 3325. *From £299*

NORTH STAR

Horizon: Z-80A, 16-56K RAM, 5¼in. twin drives, S-100 bus, own OS, business, educational or scientific use. Comart, PO Box 2, St Neots, Huntingdon, Cambridgeshire PE19 4NY. (0480) 215005. Equinox, Kleeman House 16 Anning Street, New Inn Yard, London EC2A 3HB. (01) 729 4460. Reviewed April 1979. *From £995 to £2,500*

OHIO SCIENTIFIC

Ohio Superboard and Challenger I: 6502, 8K Basic in ROM, 2K monitor, 4K RAM, full keyboard and VDU interface. Hobbyist use. Reviewed June 1979. *From £160*

Challenger 2: 6502, 48K RAM, dual 8in. drives, serial port, low-cost business use. *From £1,500*

Challenger 3: 6502, Z-80 and 6800, 48-56K RAM, OSI 48-pin bus, serial port for VDU, CP/M, expands to eight users, 10, 20 and 75MB hard disc, business use. *From £2,300*

Challenger 4: Similar to Challenger I but 64 × 32 display, colour and sound option. U-Microcomputers, Winstanley Industrial Estate, Long Lane, Warrington, Cheshire WA2 8PR (0925) 54117/8. CTS (0706) 79332. Millbank, 98 Lower Richmond Road, London SW16. (01) 788 1083. Reviewed September 1979. Mutek, Quarry Hill, Bath, Wiltshire. (0225) 743289. *From £450*

PANASONIC

Panasonic: 8085, 56K RAM, full keyboard, integral 24 × 80 VDU, integral twin 5¼ or 8in. floppy drives. Three RS232, business use. Panasonic Business Systems, 9 Connaught Street, London W2. (01) 261 3121. Reviewed June 1979. *From £4,150*

PROCESSOR TECHNOLOGY

Sol: 8080, 16K RAM, S-100 bus, 5¼in. drives, VDU integral, business system. Comart, PO Box 2, St Neots, Huntingdon, Cambridgeshire PE19 4NY. (0480) 215005. Reviewed July 1979. *From £1,750*

Business Systems Systems Development

Programs designed and written for North Star and CP/M computer systems

Consultancy

- Feasibility studies
 - Independent advice
 - Project management
 - Single source supply of complete systems.
- We specialise in accounting, order processing, invoicing and stock control systems.

McMillan Computing Services
3 Tithebarn Grove
Calcot, Reading
Tel: 0734 414751

• Circle No. 229

THE ZX80 MAGIC BOOK £4.75

For machines with 1-3K RAM. New edition 3 contains 20 plus programs including one which allows you to play music with your ZX80, and games such as Hamurabi, Moon Lander, Othello, Hexpaw and Animals. Also sections on How it Works, Plotting, Using USR, Converting Other BASICS, and hardware notes including circuits for static and dynamic memory and I/O extensions.

TIMEDATA Ltd.
57 Swallowdale, Basildon, Essex

• Circle No. 230

apple II in sussex Oval computer systems

Elm Park, Ferring, Worthing, West Sussex tel: 0903-44831
198 Church Road, Hove, East Sussex tel: 0273-558299

• Circle No. 231

Meet people on your wave length immediately though **RAPPORT**, the intelligent person's introduction service.

All ages, nationwide. Send stamp and age for details:

RAPPORT, Dept RB,
P.O. Box 94, Oxford

ADD FULL GRAPHICS TO YOUR VDU!

Does your VDU Home Computer use the Thomson SFF96364 VDU chip? (eg. Triton, Elekterminal) And do you want FULL GRAPHICS and LOWER CASE CHARACTERS? Then you need the AUTO ELECTRONICS 96364G GRAPHICS MODULE. When used in conjunction with the SFF96364 it gives access to the full 8x12 dot matrix per character not just 7x5. This allows ANY customised character set to be used (eg. Arabic) or graphics set or even high definition graphics. Character information is stored in EPROM (or even RAM) which completes the circuit. The module measures 4x4x1.3 cms. and consumes 20 mA at 5 volts. 96364G Graphics Module (with full data)

£12.65
96364GP Ready Build PCB with Graphics Module and socket for 2716/2708 EPROM (with full data) £23.00
2716 (5volt) Custom Programmed with your Character set £26.45
Prices include VAT and Postage.
Write or phone for data.

AUTO ELECTRONICS,
MOOREND GROVE,
CHELTENHAM, GLOS GL53 0EX
(0242) 515133 (after 6pm)

• Circle No. 232

NASCOM TRACE

Program development aid for the NAS-SYS Assembler programmer featuring:

- Software write protect of the Zeap buffer + 4 user specified areas
- additional break points + keyboard break
- Selection of displays including display of CALL and RET addresses
- Trace interrupts

Designed for use with Zeap 2.0; can be used with other systems. Supplied on relocatable 2708 EPROM. Price £13 inclusive. SAE for more details.

R.G. Swainson
44 Colwall Avenue Hull HU5 5SR
Tel: 0482 563 589 (evenings)

• Circle No. 233

Vets for Pets

Anita Electronic Services (London) Ltd. are specialists in the repair and service of Commodore Pets.

We offer a fast on-site service, or alternatively repairs can be carried-out at our workshops should you wish to bring in your Pet.

Pet maintenance contracts are available at very competitive prices. Trade inquiries welcomed.

For further information tel. or write to:-

• We also specialise in the repair of all makes of office equipment.

John Meade
Anita Electronic Services,
15 Clerkenwell Close, London EC1
01-253 2444

• Circle No. 234

RAIR

Black Box: 8085, 32-256K RAM, dual mini-floppy discs, eight programmable serial ports, RS232, CP/M, hard discs to 10MB, general and business use. Rair, 30-32 Neal Street, London WC2H 9PS. (01) 836 4663. Reviewed November 1979 and August 1980.

From £2,300

RCA

Cosmac: 1802 micro with Hex pad and TV interface. Machine-code programming with Tiny Basic option. HL Audio, 255 Archway Road, London N6 5BS. (01) 348 3325.

From £79 for kit

RESEARCH MACHINES

380-Z: Z-80, 4-56K RAM, RS232, CP/M, twin 5¼ or 8in. discs, high-resolution graphics. Sold principally to higher and secondary education.

From £830 to £3,500

280-Z: Board version of 380-Z. Research Machines, PO Box 75, Mill Street, Oxford. (0865) 49791.

From £722 for 4K version

ROCKWELL

Aim-65: 6502, 1-4K RAM, full keyboard, RS232, discs, hobby use, Portable Microsystems, Forby House, 18 Market Place, Brackley, Northamptonshire NN13 5SF. (0280) 702017. Reviewed July 1979.

From £250

SATTCO AB

Databoard 4680: Z-80, 16-64K RAM, own bus, full-colour graphics, 5¼in., 8in. and hard discs up to 10MB, 64 interface units. General use. Microsystems Technology, PO Box 5, Knutsford, Cheshire, WA16 9DU. (0565) 52911.

P.O.A.

SCIENCE OF CAMBRIDGE

MK-14: 8060, 256bytes user memory to which ¼K RAM can be added, Hex pad, cassette interface, seven-digit LED, single-board. Reviewed May 1979.

From £39

ZX-80: Z-80A, 1-16K RAM, 4K Basic in ROM, cassette and TV interface, touch-sensitive keyboard, educational use. 22 graphics. Science of Cambridge, 6 Kings Parade, Cambridge CB2 1SN. (0223) 311488/312919. Reviewed July 1980.

From £79 for kit

SD SYSTEMS INC

SBC-100: Z-80, 1-48K, S-100 bus, Basic in 8K ROM, four ROM sockets, optional 5¼in. drives, RS232 serial and parallel, single-board.

From £155

SD-100/200: Z-80, 64-256K RAM, 8K PROM, S-100 bus, RS232, CP/M, 12in. VDU, twin 8in. drives, business, industrial and general use. Airamco, Unit A2, 9 Longford Avenue, Kilwinning Industrial Estate, Kilwinning, Ayrshire KA13 6EX. (0294) 65533. Barcellos, Kimberley House, Vaughan Way, Leicester. (0533) 26584.

From £3,750

SEN ELECTRONICS

Organiser: Intel 8085, 64K RAM, multi-user Basic, 8in. drives or

From £7,500



20MB hard discs, three RS232, business use. SEN, 5 London Street, Chertsey, Surrey KT16 8AP. (09328) 66744.

SGS-ATES

Nanocomputer: Z-80, 6-64K RAM, Gamma bus, 2K NC-2 monitor in ROM, Basic as option, RS232, cassette interface, Hex keypad: Midwich, Hewitt House, Northgate Street, Bury St Edmunds, Suffolk, IP33 1HQ. Reviewed October 1979. *From £350*

SHARP ELECTRONICS

MZ-80K: Z-80, 16-48K RAM, 10in. integral VDU, integral cassette, loudspeaker, 5¼in. disc optional, general use. *From £480*

PC-1211: Pocket computer. Programmable in Basic with cassette interface. Sharp Electronics, Sharp House, Thorp Road, Newton Heath, Manchester M10 9BE. (061) 205 2333. Reviewed July 1980. *From £85*

SINTROM ELECTRONICS

Periflex 630/48: Z-80A, 32-48K RAM, S-100, CP/M, twin Micropolis 5¼in. discs, two serial and three parallel ports. *From £2,080 to £2,500*

Periflex 1024/64: Z-80, 64K, S-100, CP/M, dual 8in. discs, two serial and three parallel. Sintrom Electronics, Arkwright Road, Reading, Berkshire RG2 0LS (0734) 85464. *From £3,100*

SIRTON COMPUTERS

Midas Range: Z-80, from 8K RAM, S-100 or IEEE bus, CP/M, MP/M, graphics, up to four 5¼in. or 8in. drives, hard disc, RS232, 8-bit parallel, IEEE 488. Sirton Computers, 76 Godstone Road, Kenley, Surrey CR2 5AA. 01-668 0761. *£785-£2,150*

SMOKE SIGNAL

Chieftain 511-821: 6800/6809, 32-64K RAM, S-50 bus, Flex DOS68/68d/69 dual 5¼in., 8in., dual RS232, video board, wide range of options, general use. Windrush Micro Designs, Gaymers Way, North Walsham, Norfolk. (069) 245189. *From £1,807*

SOLID STATE TECHNOLOGY

Athena: 8085, integral dual mini-floppies and mini-cassette, and matrix printer, can be expanded with 10 micros beyond CPU. Memory to 1.2GB. Claims performance similar to DEC PDP-11/34. Butel-Comco, 50 Oxford Street, Southampton, Hampshire SO1 1DL. (0703) 39890. *From £3,000*

SORD COMPUTER SYSTEMS INC

M200 Range: Z-80A, 64K RAM, S-100 bus, Sord OS, graphics, 5¼ 8in. or hard discs, two RS232, integral 80 × 24 VDU. Business use. Midas Computer Services Ltd, 2 High Street, Steyning, Sussex (0903) 814523. *From £1,850 to £6,950*

SOFTWARE ENGINEER

TWO HARDWARE ENGINEERS REQUIRE A SOFTWARE ENGINEER TO JOIN A NEWLY FORMED COMPANY DEVELOPING Z-80 BASED HARDWARE WITH APPLE II. WE ARE LOOKING FOR A PERSON WHO ALSO WANTS TO SEE THEIR OWN EFFORTS REWARDED THROUGH THE BENEFITS OF RUNNING THEIR OWN COMPANY. BASIC ESSENTIAL, MACHINE CODE (Z-80/6502) USEFUL. PRESENTLY EFFORT IS PART TIME AT WELL EQUIPPED OFFICES IN SOUTHALL. DETAILS FROM ANDREW ON *01-560-1200 EXTN 144.

SHUGART

MINI FLOPPY DISC DRIVES

** THE LOWEST PRICES ANYWHERE **

SA 400 5¼" £125.00

BRAND NEW — 3 MONTH LABOUR & PARTS WARRANTY.

ENCOTEL SYSTEMS LTD
530 PURLEY WAY, CROYDON, S7
01-686 9687

• Circle No. 235

ZX80 SOFTWARE FOR 4K RAM MACHINES

C60 cassette containing four games: —
Random no. guessing game
Memory test
Reaction speed game
Hangman

Order no. ACG1 Price £6.00

C60 cassette designed for coaching for the 11+ exam. — helpful to all children 9-13 years old.

Order no. ACT1 Price £5.00

Cheques with order to:—

ROSE CASSETTES
P.O. Box 28, Solihull,
West Midlands B91 3LU.

LINCOLNSHIRE APPLE DISTRIBUTORS MICROSTAR DISTRIBUTORS

Stocks of Apples, Texas, Qume & Paper Tiger Printers, 8" Discs, Corvus Disks.

Proven Accountancy Packages Payroll, Stock Control, Job Costing, Financial Planning, Databases, Mailing, Visicalc, Word Processing and other software.

Estate Computer's Estate Agents Systems in wide use throughout the U.K. Fully Self Balancing Clients Accounting System (Property Management) now available having completed one year's test period in a medium sized practice. (Sold as Systems only).

ESTATE COMPUTER SYSTEMS
30, Carre St., Sleaford, Lincs.
Tel: (0529-305637)

• Circle No. 236



Some people would give anything to have your micro experience

Especially if you have practical experience with PASCAL on the APPLE micro computer. Richard Kaluzynski will put you in touch with them.

Knight Computer Services Limited, 14 Old Park Lane, London W1Y 4NL. Tel: 01-491 4706.



Staff Services Division of BOC Datasolve Group and a member of Computing Services Association

CHARACTERISE YOUR PET

New character sets for your PETS including £ sign, new maths and business symbols or have your own personal set made up

ONLY £20.00

PET Software Tape & Listing

from £3.00

ZX-80 - Software Tape & Listing

from £2.00

ZX 80 - Listing service - send your programs on tape to us and we list them on our printer for only £1.00 per print.

Write or telephone for details: -

ACM SOFTWARE

- 01-644-4535

214 Church Hill Road, North Cheam, Surrey, SM3 8LA.

FLOPPY DISKETTES

5¼" and 8" single and double sided/density. Available from stock at competitive prices.



Also all other computer media and supplies, including

Cassettes
Ribbons
Print Wheels



Storage Systems
Computer Files
Stationery

Michael Collins Computer Supplies Limited
52, Canbury Passage, Kingston, Surrey.
Telephone: 01-549 9441

• Circle No. 237

SOUTHWEST TECHNICAL PRODUCTS

C/09: 6800, 56K RAM, Flex OS, 5¼in, 8in. or 15MB hard discs, business, educational and scientific packages.

S/09: 6800, 128K RAM-380K RAM., Uniflex OS, support up to 16 users in foreground and background mode. Southwest Technical Products, 38 Dover Street, London W1X 3RB. (01) 491 7507.

From £3,000 to £10,000

SPENCER JOHNSTON LTD

SJL 8000: Z-80A, 64-208K RAM, integrated database system to user specifications, 8in. discs to 4MB Winchester to 80MB. Sun Computer Services, 60 Broad Lane, Hampton, Middlesex. (01) 979 9824.

From £8,000

SYNERTEC

Sym-1: 6502, 4K-64K RAM, port-expansion kit, TV interface, Kim software, hobbyist use. Newbear, 40 Bartholomew Street, Newbury, Buckinghamshire. (0635) 30505.

From £160

TANDBERG DATA

TDV Series: 8080A, 32-64K RAM, Intel bus, 4K Basic discs system in ROM, one plus three 8in. discs, or 2.5MB disc cartridge, eight ports, semi-graphics, CP/M version available, educational use. Tandberg Data, 81 Kirkstall Road, Leeds, LS3 1HR. (0532) 35111.

From £4,000

TANDY CORPORATION

Model 1: Z-80, 4-48K RAM, RS232, Level I and Level II Basic in ROM, separate keyboard and 12in. VDU, small business and personal use. Reviewed November 1978.

From £349

Model 2: Z-80, 64K RAM, integral 8in. disc, integral 12in. VDU, detachable keyboard, CP/M serial and parallel ports, Level III Basic, business use. Tandy, TRS-80 Division, Bilston Road, Wednesbury, West Midlands, WS10 7IN. (021) 556 6101. Reviewed March 1980.

From £1,995

TANGERINE COMPUTER SYSTEMS

Microtan 65: 6502, 1-48K RAM, Tanbus, IEEE 488, Tanbug in ROM (1K), Pixel graphics, 5¼in. discs, 32 I/O lines and three serial ports, from single-board upwards. Tangerine Computer Systems, Forehill, Ely, Cambridgeshire. (0353) 3633.

From £69

TECHNALOGICS

TECS: 6800, 56K RAM, Basic and Prestel terminal software, RS232, two cassette ports, two parallel ports, 5¼in. discs. Technalogs, Windmill Works, Station Road, Swinton, Manchester M27 2BU. (061) 793 6323. Reviewed November 1979.

From £895 for kit

TERODEC MICROCOMPUTER SYSTEMS

TMZ-80: Z-80, 64K RAM, CP/M, MP/M, CPNet, twin 8in., up to 32MB hard discs, multi-user business use. Terodec, 17 The Gallop, Yately, Camberley, Surrey. (0252) 874790.

From £3,000



TEXAS ELECTRONIC INSTRUMENTS (TEI)

PT-208/PT-212: 8080, Z-80, 8085, 32-60K RAM, S-100, CP/M, 5¼in., 8in. and hard discs, three RS232 and three 8-bit ports, integral VDU, business use. Abacus Data-type, 62 New Cavendish Street, London W1. (01) 580 8841. Reviewed January 1980. *From £3,500*

TEXAS INSTRUMENTS

TI-99/4: 990 16-bit, 16K RAM, Basic in 26K ROM, high-resolution, colour graphics, up to three 5¼in. discs, joystick, cassette and other ports, RS232, personal use. Texas Instruments Ltd., Manton Lane, Bedford, MK41 7PU. (0234) 67466. Reviewed August 1980. *From £950*

TRANSAM COMPONENTS

Triton: 8080, 32K RAM, CP/M, 1K TB10S in ROM, up to three 5¼in. discs, or four 8in., serial and parallel ports. Reviewed December 1979. *From £296*

Tuscan: Z-80, 8-64K RAM, S-100 bus, CP/M, RS232, TV and cassette interface, from single-board, personal use to full business system. Transam, 59 Theobalds Road, London WC1. (01) 405 5240. *From £150*

ULBRICH AUTOMATION

Powerhouse II: Z-80, 16-32K RAM, RS232, 5in. internal VDU, integral mini-cassette, 2K monitor, IEEE, 14K Basic DOS, OEM users. Powerhouse Microprocessors, 5 Alexander Road, Hemel Hempstead, Hertfordshire HP2 5BS. (0442) 42002. *From £1,200*

VECTOR GRAPHIC

MZ: Z-80, 48K-64K RAM, CP/M, 5¼in. discs, optional graphics, serial and parallel ports. Business and general use. Almarc Data Systems, 906 Woodborough Road, Nottingham (0602) 625035. Reviewed October 1980. *From £2,300*

WESTERN DIGITAL

Pascal Microengine: MCP1600, executes P-code directly, 64K RAM, own bus, 5¼in., 8in. or hard discs up to 18MB, two RS232, two parallel ports. Pronto Electronics Systems, 466-478 Cranbrook Road, Gants Hill, Ilford, Essex IG2 6LE. (01) 554 6222. *From £2,295*

ZENTEC

ZMS-70: 8080A-1, 32/64K RAM, up to 12K ROM, dual integral 5¼in. discs, 600MB, RS232, integral 15in. VDU, 16 function keys. Zigal Dynamics Ltd., Bank Chambers, 13 High Street, Chesham, Buckinghamshire. (02405) 75681. *From £4,000*

ZILOG

MCZ Series: Z-80, 64K RAM, RIO OS, Zilog bus, optional graphics, 8in. discs, and hard discs, four RS232, one parallel, stand-alone or networking. Zilog (U.K.) Ltd, Babbage House, King Street, Maidenhead, Berkshire. (0628) 36131. *From £3,000*

MICRO ADS

are accepted from private readers only, pre-paid and in writing, 20p per word, minimum charge £2.

APPLE II 16K new and unused, makers warranty. £700 o.n.o. Witcombe 3968.

TRS 80 LEVEL II 16K. Complete with Trendcom Printer, Trolley Stand, Games, Business Programmes and Spare Tapes £495. Will sell printer separately 051-526 7087.

ZX-80, 4K, with leads, manual and books of 1K Programmes. £100. Staplehurst (0580) 891622.

NASCOM 2 WANTED. M. Perry 0203 88771 Ext. 2320. Office Hours.

NASCOM-2 16K RAM. TV and Cassette. Running 4MHz. Documentation. £350. 051-339 4821.

Z-PLUS SYSTEM (Reviewed Feb. '80). 64K RAM, 1 Megabyte storage on dual 8" disks. Z80 processor, S100 standard bus, Elbit V.D.U. (full editing keyboard for word-processing). Also Diablo 1620 Daisywheel Printer (with integral keyboard). £3950 (list price for Z-Plus alone) or will consider separate sale. Variety of quality business software available. Ring Allan Lane 01-449 9942 (Day) or Radlett 5818 (After 7pm).

EX DEMONSTRATION MODEL of 3 month old TMZ-80 Microcomputer. 4 M/Bytes complete with CP/M and MBasic. £5,500. Tel. (0793) 31404.

EXAMINATION RESULTS ANALYSIS using standardisation techniques. Series of programs for 380Z min 31K in DBAS9. Details and sample output £2. On disk £24 or listings £20. R.I. Stock, Hodge Howe Lodge, Windermere.

SORCERER II, 48K, seldom used, under warranty, £520 ono. Tel. 01-205 3521.

BORED WITH SPACE INVADERS? Try ASTEROIDS — a superb new game for the SHARP MZ-80K. Cassette £5 from Martyn, 12, Knoll Road, Abergavenny, Gwent.

PET 32K. Large keyboard, new ROMS. Cassette, books, tapes. £600. Phone Saffron Walden (0799) 24244 evenings.

ZX80 SPACE INTRUDERS — zap the intruders as they attempt to land, £4.00. MOVIES — 7x8 character pictures displayed in rapid movement, gives animation effect, £3.00. Both continuous with no loss of T.V. sync. Inclusive prices for listing and details, or send S.A.E. for list of all ZX80 specials to: — K. Macdonald, 26 Splers Close, Knowle, Solihull, BP3 9ES:

COMPUTER CASSETTE PROGRAMMES duplicated from 45p. Bedoyere, Westend, Launton, Oxon. 08692 2831.

EXCHANGE BYTE, Kilobaud etc. SAE list. Smith, 84 Edenfield Gardens, Worcester Park, Surrey.

16K SORCERER with software £450. T159 with PC100C printer £200. Tel. 08894 79393 evenings.

PET 16K large keyboard with cover, cassette, manuals, BASIC course, immaculate £550. 01-948 3781.

PET/6502 Software problems? Programs tailored to suit your own requirements — contact A. Mason, at: 214 Church Hill Road, North Cheam, Surrey. Prices competitive!

FOR SALE SWTP 6800. 16K Spare boards. AC30 interface. CT64 VDU. Video monitor green. Stevenage, Herts. Tel. (0438) 60120 evenings.

ZX80. Free leaflet explains how to cure LOAD problem, etc. Supplied free with 4 games on cassette. Send £3. Bobker, 29 Chadderton Drive, Unsworth, Bury, Lancs.

NASCOM PROGRAMMES Mancala £3.50, Numeria £4.50, Wumpus £2, Lunar Lander £2, Zombie Island £2.50, Re-number £2. For full list and further details SAE 27 Beaumont Avenue, Sudbury, Middx. HA0 3BZ.

6809 S100 COMPUTER, 24K RAM, keyboard and VDU, 2400 baud cassette interface, also Editor/Assembler and Basic packages and more. £800 o.n.o. Ring Aaron James 01-959 4851.

NASCOM 162. IBM GOLFBALL INTERFACE. SAE for software and hardware details. Requires NAS-SYS. Dick Cummings, 9 Dunearn St., Glasgow, G4 9ED.

UK101 — COMPREHENSIVE BASIC editor on cassette. Flashing cursor and twenty commands: Edit, Renumber, Auto-number, Locate, Go on, Step up, Down, Cursor Forward, Back, Insert, Omit, Home, Second line, Exclude, Zero, Normal, Preserve, Twin, Write, Keep. Occupies 1.1K machine code memory at top of 8K RAM. For standard monitor only. £8 inclusive. Stewart Peppiatt, 4 Marney Close, Chelmsford, Essex, CM2 7LR.

TI PROGRAMMER Calculator and Charger. £35. Phone 0869 40408.

PET 2001-8K MANUALS £375, separate audio cassette drive £40. Cash Only. 01-550 3595 evenings.

ZX80 4K Programs: Startrek, Pontoon, Adventure, £5.95. (£2.45 each) M. Bates, Dever Barn, Micheldever, Winchester, Hants.

Son of Hexadecimal Kid

A parable in eight virtual pages by Richard Forsyth

Johnny McNull, guided by a mysterious sign in the sky, has arrived at Sprocket's Hole in time to witness the birth of Cleo's child.

Cleo named her little boy Samson, after his father. The Hexadecimal Kid had been known to almost everyone simply as Hex, but she had always preferred his real name, Sam Synapse.

She asked McNull to be the baby's godfather. McNull, flattered by the request, agreed readily, and his visits to Sprocket's Hole became much more frequent. He took a keen interest in the boy's upbringing, and it was only with great difficulty that Cleo persuaded him to keep secret the boy's ancestry — for little Samson was a direct descendant of Abraham Synapse, now revered as a Nullard saint.

So the infant grew into a youngster at Sprocket's Hole, looked after by his mother and aunt, and visited frequently by Johnny McNull. There were also in attendance Piltown 2 and the shadowy figure of Bill Bootstrap.

Every morning, Samson used to walk nearly six kilometres to the village school in what had been the Silicon Valley human reservation, since re-christened Happy Valley. His schoolmates teased him mercilessly about the diabolical black arts — such as assembly-language programming — rumoured to be practised by Bill Bootstrap when the moon was full. Living on the fringe of events as they did, that was one of the few signs they saw of the completeness with which the new orthodoxy of Nullard had won over the hearts and minds of the people.

Its effect on Samson was to change his attitude towards Bootstrap from fear to curiosity. He was particularly puzzled by the way his mother tolerated Bootstrap's presence while clearly disapproving of him.

One day, when he was 10 years old, he arrived home from school to find Johnny McNull's donkey tethered outside the house. He stole in quietly and found McNull in the kitchen chatting with his mother about the old days before the System Crash.

That afternoon, some of the older children, who had been more fully indoctrinated about the evils of computers, had taunted him in a particularly vicious manner. One had even called him a bit-slice processor. He hardly knew what they were talking about; so, since McNull was reputed a wise teacher, he decided to try and discover.

"Hello Uncle", he said as he walked through the door, "what's a silicon chip?"

Both adults turned suddenly, taken aback by his unannounced entry. There was a moment of cold silence.

"Hush, son", his mother admonished him. "Don't talk about such things. Those days are over".

"But you were talking about those days. I know you were. I heard you".

McNull drew himself up to his full height, which was scarcely more than the boy's and attempted to tower over him.

"Be thankful", he declaimed, "that thou art not tainted with the stains of the past; for I tell thee that computers were the work of the devil. That which men called the System was a great wickedness, a destroyer of all mankind, and we must be for ever on our guard against any who seek its return. Ask, therefore, no more on these matters, that thy innocence be not corrupted".

Samson sat down rebuked. His mother started setting out his tea, and tried to turn the conversation to other topics. Yet as he ate in silence, he resolved to learn all he could about the forbidden secrets of computing. There was only one person left to ask — the formidable Bill Bootstrap.

His opportunity arose a few days later while his mother and aunt were busy in the vegetable garden and Piltown 2 collecting firewood. He observed Bootstrap slinking off towards the hills which bordered their dwelling-place. He followed cautiously, well behind, and was struck immediately by the change in Bootstrap's habitual demeanour. Instead of the ambling shuffle of the doddering dotard, his stride was quick and purposeful.

After 20 minutes or so, Bootstrap stopped by a large cedar tree and looked around. Samson darted into the undergrowth, grazing both knees as he dived. Peeping out, he saw that Bootstrap was digging under the branches. Reckoning that his quarry was sufficiently engrossed, he crept up for a closer look.

Abruptly Bootstrap turned on him. "What have you followed me here for?" he demanded.

"I want to know about silicon chips", blurted out the young lad.

"So you're interested in microprocessors, are you?" A rare smile creased the android's features. "Well, you've come to the right place. Just stay there and watch".

Bootstrap resumed his digging. Soon he unearthed a large wooden chest, bound with ropes. He untied them and flung open the lid.

"There you are," he declared. "Gaze your fill. You won't see much of that around these days."

It was a veritable treasure chest. Samson was staring down at possibly the finest collection of microelectronic hardware still in existence. There were ROMs, RAMs, EAROMs, PROMs, UARTs, LEDs, processors of various technologies — Schottky TTY, NMOS, PMOS, CMOS and I²L —

circuit boards, motherboards, disc-controller cards, a colour TV with video-dazzler interface, heaps and heaps of floppy discs and — most valuable of all, though he did not know it at the time — 50 back copies of the CP/M User Group Newsletter.

Even the carpentry was impressive. There was a place for everything, and everything was carefully put away in its proper place. There were boxes within boxes, neat little sliding partitions and shelves for the software manuals. He was looking at a decade of dedicated work.

Bootstrap drew out a pinewood box with a touch-sensitive keypad engraved on its upper surface, connected it to the TV set and slotted an 8in. floppy into its side.

"Go ahead", he urged, "try it: type J 0000".

Gingerly, Samson obeyed. The screen flickered, then the message 'CP/M Version 23.04M, Copyright Mae West Software Shop' appeared, followed by the question 'Menu (Y/N)?'.

"Not bad, eh?" enquired Bootstrap. "Menu-driven CP/M. I modified it myself. What you are looking at there is the Moonshine Micro — a scientific business system on a chip. You want word processing? You want high-resolution colour graphics? They are right here. You want screen-based editing with full cursor control and programmable forward and reverse scrolling? Just press one key".

Samson was not sure he wanted editing with full cursor control, still less programmable forward and reverse scrolling, but he nodded appreciatively. He had tapped a rich seam of high-pressure sales patter in the normally taciturn Bootstrap, who had for so long been forced to hide his true colours. Now that he had found an audience — albeit a poorly-informed one — years of repressed jargon gushed out like a geyser. Samson just let the buzzwords flow over him. When at length the flood abated he asked "can it play Space Invaders"?

Bootstrap tapped his forehead with the inside of his palm. "We have indexed sequential file-handling; we have PL/I; we have multi-processing; we have stock control; we have payroll; we have nominal ledger, bought ledger, sales ledger and general ledger; we have compilers, interpreters, assemblers and more text editors than a cat has fleas; we even have a chess program better than Bobby Fischer — but does he want to see them? Oh no, he wants to play Space Invaders".

"So it doesn't have Space Invaders?" concluded the boy, disappointed. Well does it?

Copyright ©1980, Richard Forsyth

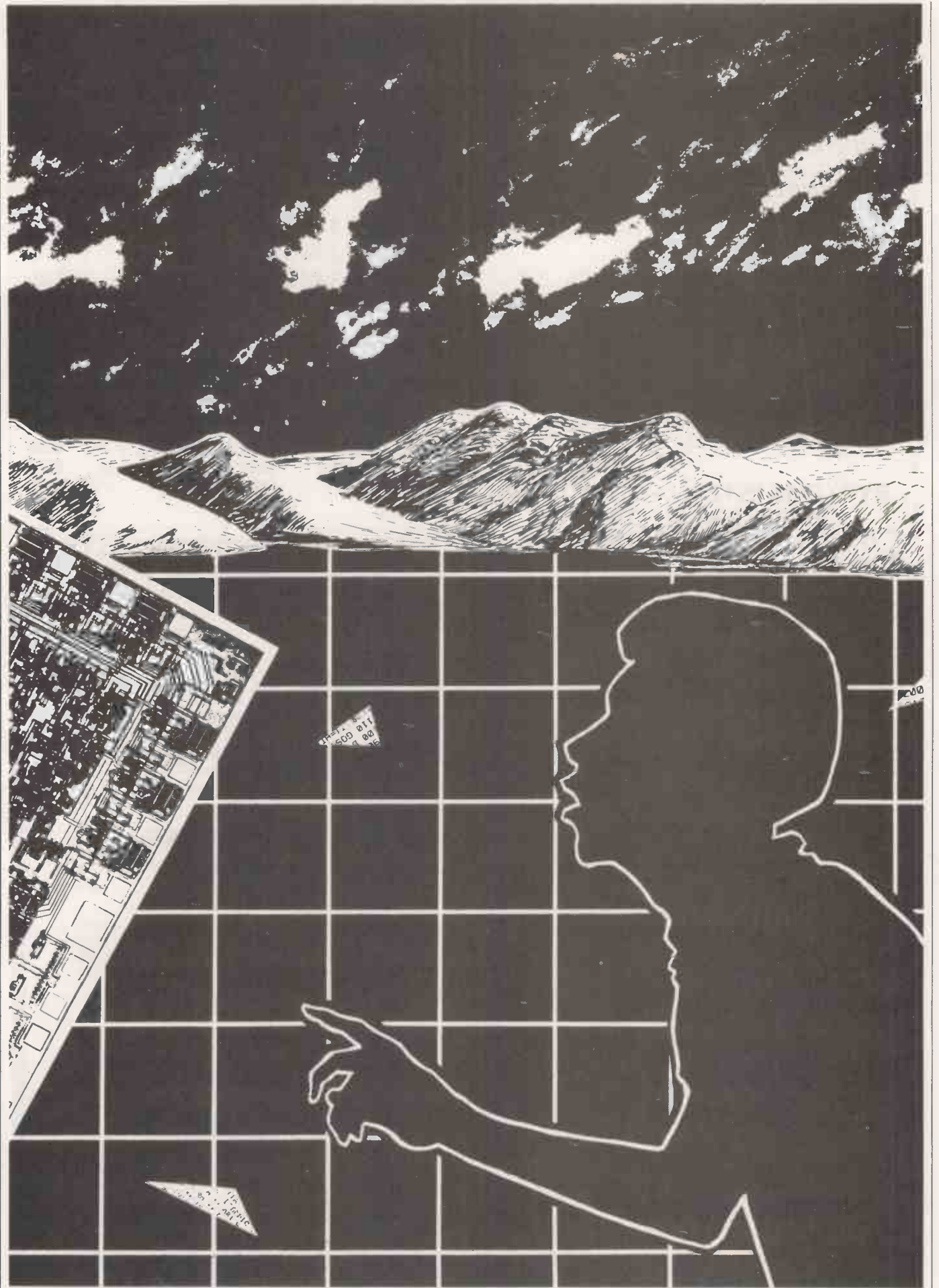

"ATTENTION COMPUTER DEALERS"

Let us be your Exporter/Purchasing Agent in the United States for the following products:—

MICROCOMPUTERS:— Ohio Scientific, Onyx.

PRINTERS:— Okidata, Centronics, NEC, Xerox/Diablo, Anadex, Printerm, Eaton.

TERMINALS:— Micro-term, Televideo, Hazeltine, Zintec, Beehive.

MAG-TAPE:— Alloy engineering cartridge and reel.

FURNITURE:— Printer Stands, CRT Stands, Computer Tables.

MISC:— Blank Floppy Disks, Blank Cartridge and reel mag tape, CRT Cables, etc.

NOTE

IF YOU DON'T SEE YOUR NEEDS, PLEASE CONTACT US WITH YOUR REQUIREMENTS.

SYSTEMS INTERNATIONAL INC
15920 LUANNE DRIVE
GAITHERSBURG, MARYLAND
20760 U.S.A.

Telephone 301-977-0100. Telex 710-828-9703
Cable Address SYSINTL. GAITHERSBURG MD

• Circle No. 238

THE BUSINESS SOLUTION TERODEC

1 to 4 MBytes 8" floppy discs
64K RAM as standard fitting
CPM OPERATING SYSTEM
4 M Hz Z80 CPU

All built into a polished wooden desk.

TMZ 80 1 MByte	£3995
TMZ 80 2 MByte	£4295
TMZ 80 4 MByte	£5595

Prices exclude VAT.

LANGUAGES AVAILABLE
Fortran, Cobol, Pascal, Basic.

GRAHAM DORIAN SOFTWARE

Job Costing	£500	Order Entry & Inv.	£500
Nominal Ledger	£500	Purchase Ledger	£500
Sales Ledger	£500	Payroll	£500

HIBBERD ELECTRONICS LTD.

2 Sarsen Close. SWINDON. Wiltshire.

Tel. Number 0793-31404/35377

(24 HOUR ANSWERING SERVICE ON 31404)

• Circle No. 239

ADVANCED COMPUTER EQUIPMENT (LEEDS) LTD

95 MEADOW LANE LEEDS 11-0532 446960

NEW MICROCOMPUTER STORE NOW OPEN

PRICES SHATTERED

COMMODORE PET

32K PROFESSIONAL KEYBOARD	
GREEN SCREEN	£575
DUAL DISK DRIVE 347K	£625
CASSETTE DECK C2N	£ 50
PRINTER 3022 MATRIX TRACTOR	£375

SHARP Z-80

48K WITH 34K USER RAM	£474
36K WITH 22K USER RAM	£422
20K WITH 6K USER RAM	£380
DISK DRIVES, PRINTERS ETC.	

PRINTERS

BD80P HI-SPEED BI-DIRECTIONAL WITH ADJUSTABLE TRACTOR FEED 750 BYTE BUFFER. FANTASTIC OFFER £395
IEEE * PARALLEL OR RS232

APPLE II PLUS

48K AUTO START	£695
DISK WITH CONTROLLER	£345
DISK WITHOUT CONTROLLER	£295
HITACHI 9" MONITOR B/W	£120

SUPERBRAIN

64K WITH SINGLE DENSITY 320K DISK	£1450
32K WITH SINGLE DENSITY 320K DISK	£1395
64K WITH DOUBLE DENSITY 700K DISK	£2300
OPERATING SYSTEM * MBASIC *	
COBOL * FORTRAN	

SUNDRIES

DATA TAPES SUPER QUALITY (10)	£ 3.75
5 1/4" CERTIFIED VERBATIM (10)	£27.00
PLAIN LISTING PAPER 2000 SHEETS	£12.50
BOOKS * GAMES * PROGRAMS * GALORE	
VISICALC * DESKTOP PLANNER	
SPECIAL OFFER	

PLEASE ADD VAT TO ALL GOODS EXCEPT BOOKS — CASH AND CARRY OR 24HR DELIVERY — YOUR CHOICE

ALL EQUIPMENT IS FACTORY FRESH AND FULLY TESTED IN OUR OWN WORKSHOPS

STANDARD CONDITIONS OF SALE APPLIES TO ALL PRODUCTS

• Circle No. 240

FREE!
Every Ten-Pack Order

FACTORY FRESH BRAND NAME

MINI DISKS

At Discount prices rushed to you by post

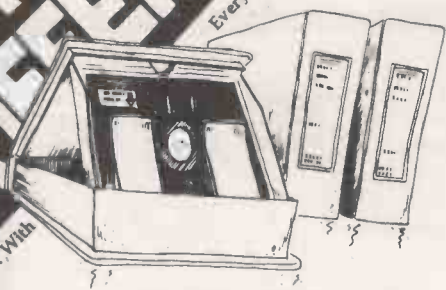

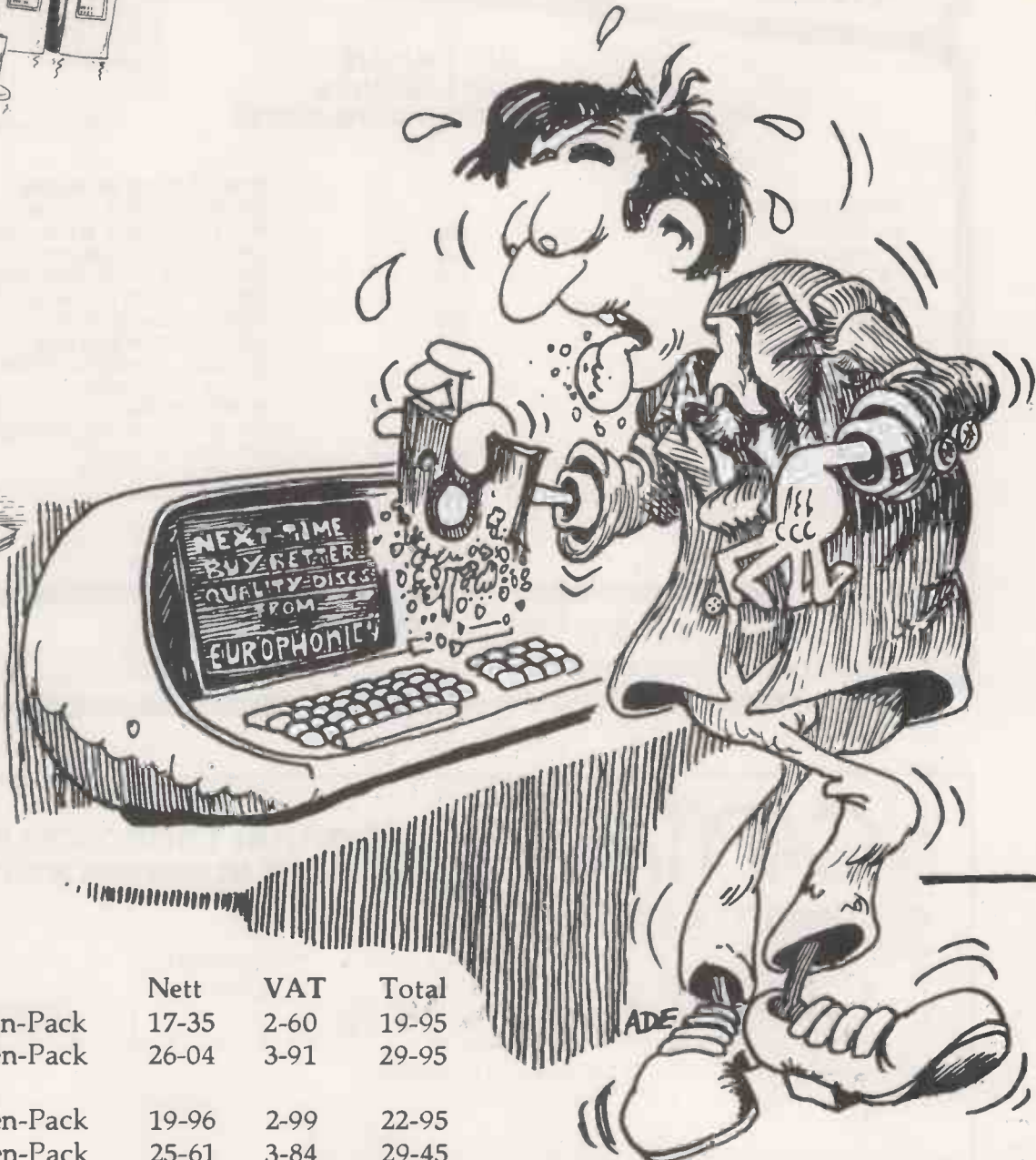

Library Box design may vary

+ PLUS +



Order 2 or more Ten-Packs, and we will also give you a FREE 'EUROPHONIC' Disk Directory with every pack, so you need never wonder what's on your disks again!

	Nett	VAT	Total
 single sided Ten-Pack	17-35	2-60	19-95
double sided Ten-Pack	26-04	3-91	29-95
 single sided Ten-Pack	19-96	2-99	22-95
double sided Ten-Pack	25-61	3-84	29-45

UK p&p + 50p, Export (EEC) + £1.00

We only sell top quality disks, with manufacturers full guarantee. In addition, **EUROPHONIC** undertake to refund your money in full, should you be dissatisfied with your purchase, for any reason whatsoever.

If you're not sure which disk suits your drive, write or 'phone 0428 722563 any time.

If order form has been cut send your cheque payable to **EUROPHONIC** FREEPOST, Liphook, Hants, GU3 7BR.

To: **EUROPHONIC**,
FREEPOST, Liphook, Hants, GU3 7BR.

Please send me:	Qty	Total
Verbatim s/s Ten-Pack at 19.95		
Verbatim d/s Ten-Pack at 29.95		
BASF s/s Ten-Pack at 22.95		
BASF d/s Ten-Pack at 29.45		
UK dly & ins + 50p per Ten-Pack		
Total value of cheque enclosed		£

Please make cheques payable to **EUROPHONIC**

Name: _____

Address: _____

151

INTELLIGENT ARTEFACTS LTD.

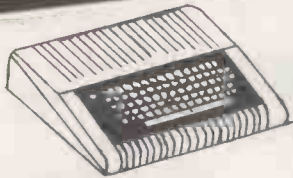

**BEST VALUE
BEST SERVICE
1 YEAR GUARANTEE**



PROFESSIONAL COMPUTERS

HOME COMPUTERS

	£
Acorn Atom	150
Challenger 8K	359
Pet 16K	480
Pet 32K	580
Super Pet (8032)	799
Texas TI994 + Scantic	499
PRINTERS	
Epson + Interface	349
Base 2	349
DISKS	
Texas + Controller	339
Pet 2040	590
Super Pet 8050	825
Many Extras	
Pet cassette	49
Pet Toolkit	39

NORTH STAR HORIZON

	£
32K DD 2 serial + Parallel I/O	
4MHz Z-80 Dos + Basic dual drive	1450
32K QD Density dual drive	1690
48K Double Density dual drive	1690
48K QD Density dual drive	1950
Expansion boards from	249

ACCOUNTS PACKAGE

Software, North Star, Printer	
VDU + free support	3300

SUPER BRAIN

(Integral Disk drive and VDU)	
32K RAM 320K DISK	1499
64K RAM 320K DISK	1650
64K RAM 788K DISK	1895

Many Extras
Paper, Disks, Cassettes etc.
PRICES EX VAT

INTELLIGENT ARTEFACTS LIMITED

DISCOUNT HARDWARE AND SOFTWARE

Cambridge Road, Orwell, Royston, Herts.
Telephone: ARRINGTON (022 020) 689

• Circle No. 242



CAPITAL COMPUTER SYSTEMS

**CENTRAL LONDON'S LEADING
COMMODORE BUSINESS SYSTEMS DEALER**



Phone us or call in at anytime from Monday to Friday (and on Saturday to 1 p.m.) for professional advice and demonstrations on the complete range of Commodore products. We also stock a wide variety of Software and Hardware accessories for the Commodore as well as for other Micros.

Call us for a Free comprehensive price list of equipment and software on offer.

Access and Barclaycard accepted.

32 WINDMILL STREET, LONDON W.1.
TEL: 01-636 3863 (3 LINES) TELEX: 298531 (TAPE 1)



• Circle No. 243

APPLE® II DISK DRIVES

DUAL DISK UNIT

£498

DISK CONTROLLER CARD

£ 49

- * Two Disks in one Cabinet
- * Has its own Power Supply Unit
- * Connects to standard Apple Disk Controller Card
- * Runs all Apple Software including Pascal
- * Japanese quality and reliability

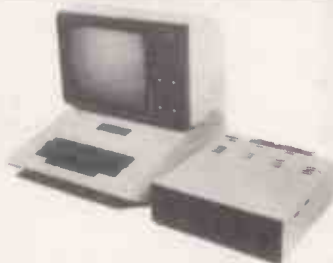

APPLE DEALERS:- Write or phone direct to Cumana and specifications plus dealer discounts will be mailed to you.

TRS-80® DISK DRIVES

DUAL DISK UNIT

2 x 40 Track Drives
2 x 80 Track Drives

£440
£645

SINGLE DISK UNIT

1 x 40 Track Drive
1 x 80 Track Drive

£236
£345

TRS 80 DISK CABLES

2 Drive Cable
4 Drive Cable

£20
£32.50

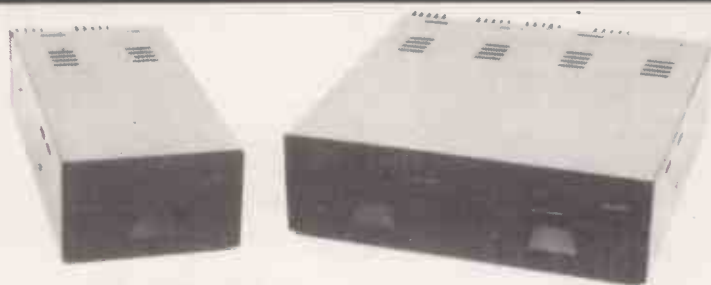

TRS-80 DEALERS:- Write or phone direct to Cumana and specifications plus dealer discounts will be mailed to you.

EDUCATIONAL & QUANTITY DISCOUNTS

VERY GENEROUS EDUCATIONAL AND QUANTITY PURCHASE DISCOUNTS ARE NOW AVAILABLE ON CUMANA TRS 80 DISK DRIVES. OUR DEALERS WILL BE HAPPY TO SUPPLY PRICE QUOTATIONS

Call your nearest dealer for a demonstration:

RADIO SHACK LTD.,
188, Broadhurst Gardens,
London NW6
Tel: 01-624-7174

COMPSHOP LTD., 14, Station
Road, New Barnet, Herts.
Tel: 01-441-2922

COMPSHOP LTD.,
311, Edgware Road,
London W2, Tel: 01-262-0387

MICRO CONTROL LTD.,
224, Edgware Road,
London W2, Tel: 01-402-8842

**LONDON COMPUTER
CENTRE**, 43 Grafton Way,
London W1, Tel: 01-368-5721

**TRANSAM COMPONENTS
LTD.**, 59-61, Theobalds Road,
London WC1
Tel: 01-405-5240

N.I.C. 61, Broad Lane,
Tottenham, London N15
Tel: 01-808-0377

**KATANNA MANAGEMENT
SERVICES**, 22, Roughtons,
Galleywood, Chelmsford.
Tel: 0245-76127

I.C. ELECTRONICS,
Flagstones, Stede Quarter,
Biddenden, Kent.
Tel: 0580-291816

**CAMBRIDGE COMPUTER
STORE**, 1, Emmanuel Street,
Cambridge, Tel: 0223-65334

**PORTABLE MICRO-
SYSTEMS**, 18, Market Place,
Brackley, Northants
Tel: 0280-702017

COMPUTERAMA LTD.,
5, Cleveland Place East,
London Road, Bath,
Tel: 0225-333232

ENSIGN, 13-19, Milford
Street, Swindon, Wilts.
Tel: 0793-42615

SEVET TRADING, 14, St.
Paul's Street, Bristol 2
Tel: 0272-697757

PARWEST LTD., 58, Market
Place, Chippenham.
Tel: 0249-2131

**HEWART MICRO-
ELECTRONICS**, 95, Blakelow
Road, Macclesfield.
Tel: 0625-22030

HARDEN MICROSYSTEMS,
28-30, Back Lord Street,
Blackpool, Tel: 0253-27590

MICRO CHIP SHOP,
197, Waterloo Road, Blackpool.
Tel: 0253-403122

MICRO CHIP SHOP,
190, Lord Street, Fleetwood,
Lancs. Tel: 03917-79511

EWL COMPUTERS LTD.,
8, Royal Crescent, Glasgow.
Tel: 041-332-7642

**NORTH WEST COMPUTER
CONSULTANTS LTD.**,
241, Market Street, HYDE,
Cheshire
Tel: 061-366-8624

ZERO ONE ELECTRONICS,
36, Oaklands Avenue,
THORNTON HEATH,
Surrey
Tel: 01-689-7924

P & J EQUIPMENT LTD.,
3 Bridge Street,
GUILDFORD
Tel: 0483-504801

CUMANA LTD 35 Walnut Tree Close, Guildford, Surrey, GU1 4UN.
Telephone: (0483) 503121. Telex: 859680 (Input G).

Please add VAT to all prices.

Delivery at cost will be advised at time of order.

• Circle No. 244

OHIO SCIENTIFIC SUPERBOARDS WITH 32 x 32 DISPLAYS



CHEAPO EXPANSION OFFER
Buy a 610 expansion board with 8K ram on board and space for another 16K for £159 + 15% and get a free 5V 2A power kit and any extra ram you want for £3.50/K + 15%. Buy a minifloppy + case + power supply + 2 copies dos for £275 + 15% with the 610 and we will do the extra ram for £2/K + 15% (Up to 16K).

Announcing the new 50Hz guard band models with 1.5MHz clocks giving 50% more speed, a full 32 x 32 display and a multi-speed tape interface.

BLACK AND WHITE
£159 + 15% post free.
COLOUR VERSION
£225 + 15% VAT.

THE UNIQUE SPECIAL OFFER YOU CANNOT RESIST

If bought with Superboard these items are at the reduced prices shown first. Also sold separately at the bracketed prices. Add 15% Vat. Guard band kit £0 (£8). Modulator and power supply kit £1 (£25). 4K extra ram £20 (£24). Display expansion kit approx 30 lines x 54 characters £15 (£20). Case £23 (£26). Colour conversion board kit £35 (£45) or built £65 (£65). Cassette recorder £14 (£16). CEGMON improved monitor rom poa. Extended monitor (tape) £20 (£20). Assembler/Editor £25 (£25). Word processor £10 (£10).

PRINTERS



The best value in matrix printers and a fantastic cheapo offer to boot. OKI Microline 80 (Illustrated) £359 + 15% BASE 2 800B (New improved version of the 800MST) £359 + 15%. BASE 2 850 Model price by secret quotation only. Anacom 150 £699 + 15%. Buy any of the above and we will supply an interface kit and word processor program for Superboard for only £1.

THE NEW OHIO SERIES 2 CHALLENGER C1P

Program selectable 24 x 24 or 12 x 48 displays. Sound, music and voice output. 8K ram expandable to 32K. 8K basic. We dare not publish our cheap price for fear of being gunned down in the street by desperate rivals. Send a highly opaque sae for a stunning quote from the masters of cheapo and freebie trading. We also stock the C1PMF Series 2 disc version. Again, secret quotations only.

SWANLEY ELECTRONICS

Dept. P.C., 32 Goldsel Rd., Swanley, Kent BR8 8EZ.

Telephone Swanley 64851.

Please add 40p postage. Prices include VAT unless stated.

Lists 27p post free. Overseas customers deduct 13%. Official credit orders welcome.

• Circle No. 245



CHROMADAPTOR

COMPUTER COLOUR INTERFACE

FOR YOUR PET

FEATURES

- * Sixteen colours available under software control.
- * High performance 8MHz UHF modulator for a crisp display.
- * Audio output via PET's user port available from Television Speaker.
- * High quality 12" x 9" x 3 1/2" metal casing.
- * Fully assembled, tested and guaranteed.

FACILITIES

- * Background and Foreground colours are individually selected for every screen character location.
- * Allows all of PET's characters and graphics to be programmed in colour.
- * Absolute simplicity of operation and programming.
- * Simple conversion of existing Black and White programmes to colour.
- * Background and/or Foreground colours of total screen area may be changed using only three instructions.
- * All facilities available using either BASIC or machine code.
- * May be used with old or new ROM PETS.

DOCUMENTATION

- * Full instructions provided.
- * Free colour games and demonstration programmes provided.
- * All connecting leads included, even a 12 AMP mains plug.
- * Rapidly growing colour software library.
- * Colour TOOL KIT incorporating additional BASIC instructions available soon.

The all inclusive price for the CHROMADAPTOR is £295.00 plus VAT and £2.50 post and packing.

Also available. MONADAPTER Black & White interface for PETS. Features:— Choice of black on white or white on black. Sound from T.V. speaker £45.00 + V.A.T.

DEALER ENQUIRIES WELCOME

SADEKTRONICS LTD.

North West House 45 West Street Brighton BN1 1RR

Tel: 0273/29949 Telex: 877159SAD

• Circle No. 246

NewBear Computing Store Ltd



PLEASE ADD V.A.T. TO ALL PRICES.

MICROCOMPUTING I.C.'S

MC6800	£6.75
MC6802	£10.50
MC6809	£17.75
MC6810AP	£3.61
MC6821	£4.63
MC6840	£10.50
MC6850	£4.99
MC6852	£4.75
Z80 CPU 2.5 Mhz	£8.99
Z80 CTC 2.5 Mhz	£7.99
Z80 P10 2.5 Mhz	£7.99
Z80-S10/0	£25.57
Z80A CPU 4 Mhz	£10.50
Z80A P10 4 Mhz	£10.00
Z80A CTC 4 Mhz	£10.00
SC/MP 11 (INS806ON)	£11.30
INS8154N	£8.18
6502	£8.99
6522 VIA	£8.14
6532	£9.75
6545 CRT CONTROLLER	£18.50
6551 ACIA	£9.99
8080A	£5.50

MZ-80K

NBMZ80K MONITOR LISTING	£15.00
NBMZ80K BASIC LISTING	£30.00
NBMZ80K ZEN EDITOR/ASSEMBLER TAPE & MANUAL	£19.50
MZ80K MACHINE CODE TAPE & MANUAL	£22.50
MZ80K ASSEMBLY LANGUAGE TAPE & MANUAL	£45.00
NBMZ80K V24/RS232 PRINTER INTERFACE	£49.50

DISKS & PRINTER NOW AVAILABLE
A COMPLETE BUSINESS SYSTEM FOR
LESS THAN £2000.

SPECTRONICS U.V. EPROM — ERASING LAMPS FROM £45.00.

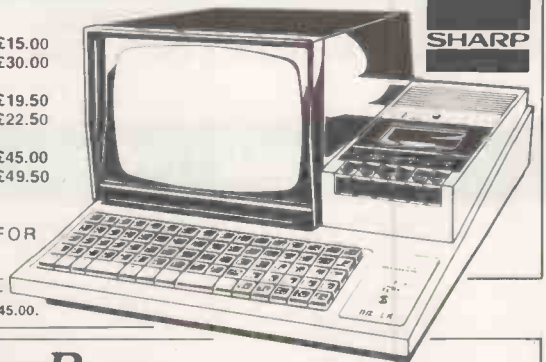

NEW LOW PRICES!

C.I.T.O.H. 8300 R.M. PRINTER



NewBear

for the widest selection of computing books
NEW BOOK LIST

MEMORIES

4116 (16K DYNAMIC)	£4.50
2716 (INTEL + 5V TYPE)	£12.50
2708	£4.50

SALE

January 19 to 30.
Many Bargains and
Special Offers.
AT ALL Branches.

NEWBEAR COMPUTING STORE LTD, (HEAD OFFICE) 40 BARTHOLOMEW STREET, NEWBURY, BERKS
TELEX 848507 NCS
MAIL ORDER TEL. (0635) 30505
FIRST FLOOR OFFICES, TIVOLI CENTRE, COVENTRY ROAD, BIRMINGHAM. TEL. 021 707 7170
220-222 STOCKPORT ROAD, CHEADLE HEATH, STOCKPORT. TEL. 061-4912290

**GET A SHARP DEAL
FROM NEWBEAR**
SEND FOR OUR
FREE CATALOGUE

• Circle No. 247

What will you do with 12-year-old programmers when they reach 16?

Any microcomputer is a major investment for an educational establishment. Many potential users feel that a BASIC only computer is ample for their needs. That may be fine today, but with computer education starting so early you may in a surprisingly short time find you want more than current implementations of BASIC.

The 380Z is a computer that can grow to match your needs.

In the design of the 380Z our target user is the graduate research scientist. This ensures that the expandability and versatility needed tomorrow has been provided for in the computer you buy now.



Might you want to add disc storage in the next few years?

If you do:

Given good hardware, software availability completely determines the flexibility and usefulness of your system. There is absolutely no question that a Z80 based micro-computer which uses the industry-standard CP/M* disk operating system has several times more software on the market available to it than non CP/M computers.

Today you can purchase a mature CP/M BASIC, FORTRAN, COBOL or Text Processor for the 380Z. Soon there will be CP/M Pascal and Database Management systems.

CP/M software is several years ahead of software available for non CP/M family machines.

If you don't:

Remember that professionals writing packages for your cassette system will themselves often use a disk 380Z, and the power of their tools will influence what they produce.

For many people a disk machine is too expensive - but at least the 380Z

approach will allow your students to advance.

380Z BASIC is not frozen in ROM. An enhanced BASIC could be loaded in mid 1980 and a BASIC with structured features sometime later.

On the 380Z the memory used by a BASIC interpreter can also be used for other software.

Does our research-oriented design pay off in classroom hardware?

Our scientific graphics was produced for the professional user. Interest in it for classroom use has been surprising.

The 380Z has the best graphics now available on a microcomputer,

allowing multiple resolutions, multiple paging, fading and accurate control over colour. All these features help bring excitement to efforts in computer assisted learning.

Our standard machine comes with low resolution graphics and support for this from BASIC allows you to plot a point directly with a plot command - useful for training and teaching.

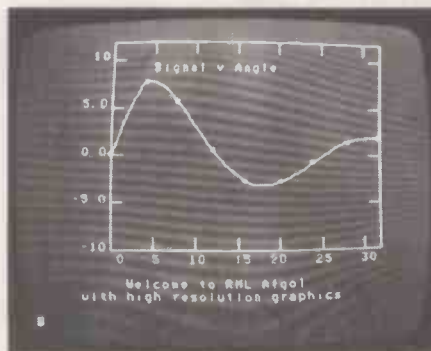

It is worth remembering too that neither our low resolution graphics nor our optional scientific (high resolution) graphics has any limiting effect on your memory usage, and in both you can



freely mix upper and lower case text and diagrams.

Mains noise can cause system crashes which result in loss of programs and data. All current 380Zs include a mains filter which significantly reduces the chances of this happening.

Don't buy a 380Z on patriotic grounds.

Please only buy it if you would have bought it anyway. But remember, because it is designed and manufactured here you are bound to have better access to us for influence and help than if we were on the other side of an ocean.

Prices range from a 16K cassette 380Z @ £897 to a 56K Dual Full Floppy Disk 380Z @ £3322.

LOWER COSTS

Three things have happened which make it easier to buy a 380Z.

ONE: From 1st November 1979 most prices have been reduced.

TWO: Schools and some colleges can now get a 5% discount on computer orders.

THREE: A new Local Authority quantity discount scheme has been introduced to make it easier for more users to benefit from quantity purchasing.

Please contact the Sales Office for details.

RESEARCH MACHINES

RESEARCH MACHINES Ltd,
PO. Box 75, Mill Street, Oxford, England.
Telephone: Oxford (0865) 49791/2/3.
Please send for full sales information.
Prices do not include shipping costs or VAT @15%.

* Trademark, Digital Research.

• Circle No. 248

SOFTWARE FOR CP/M®

HIGH QUALITY SOFTWARE – WITH HIGH QUALITY SERVICE

WORDSTAR - Professional word processing software. On-screen formatting, wordwrap, pagination, line and character count on view. Micro-justification on daisy-wheel printer. Search and replace. Block/paragraph manipulation. External file read/write. Background printing during editing etc.	£250	IBM - CP/M COMPATIBILITY - Powerful utility giving micro's the ability to act as IBM Data Preparation system with added benefit of micro processed data being available to IBM computer and vice versa.	£110
MAIL-MERGE - Wordstar enhancement for personalising documents.	£65	CIS - COBOL - ANSI '74 implementation to full level 1 standard. Supports random, indexed and sequential files, features for conversational working, screen control, interactive debugging, program segmentation etc.	£425
CONFIGURABLE BUSINESS SYSTEM (CBS) - Unique information management system with user definable files, powerful report generator, menu-driven for ease of use. No programming experience necessary!	£175	FORMS-2 - Automatic COBOL code generator for screen formats	£100
SELECTOR III - C2 - Information management system written in CBASIC-2. Maintains multi-key data base files and produces sorted formatted reports. Package includes simple application programs.	£185	CBASIC-2 - Extended Disk Basic pseudo compiler and run-time interpreter. Widely used for commercial packages	£75
SELECTOR IV - Upward compatible enhanced version of Selector. Includes file format conversion, field computation, global search and replace, enhanced report formatter etc.	£300	MICROSOFT BASIC INTERPRETER	£155
GLECTOR - Superior General Ledger application utilising the power of Selector	£200	MICROSOFT BASIC COMPILER	£195
MAGSAM - Keyed file management system for use with CBASIC-2. An extended version of ISAM includes secondary indexing and deleted space reclamation.	£130	MICROSOFT FORTRAN COMPILER	£270
ACCOUNTING PACKAGES by Median - Tec: PAYROLL, SALES, PURCHASE, NOMINAL Specially developed by UK software house to exacting specifications. each Written in Microsoft Basic each package may be customised by end user, all are widely used. Ledgers are open item. Payroll caters for weekly and monthly pay.	£500	STRUCTURED BASIC - Relocatable compiler combining the flexibility of Basic with the power of advanced structured techniques	£140
PROJECT COST CONTROL - A comprehensive set of programs to monitor budgets, account for expenditure and project completion etc. Ideally suited for contractors. Written in CBASIC-2.	£150	SUPERSORT - Sort, merge and selection program	£140
DATASTAR - Data preparation facility with screen form design, field validation, duplication etc. Menu driven. Compatible with CP/M and Wordstar files.	£175	WORDMASTER - Full screen text editor	£85
		TEXTWRITER III - Text formatter with many features	£80
		STATISTICAL & MATHS ROUTINES - Over 40 useful routines easily used.	£150
		BSTAM - Telecomms facility for exchanging files between CP/M computers. Error detection and automatic retry with console messages.	£75

Please contact us for availability of other products
All orders must be PREPAID. Add 50p per item P & P (Minimum £1) and VAT
*CP/M is trade mark of Digital Research



TELESYSTEMS LTD

P.O. Box 12, GREAT MISSENDEN, BUCKS, HP16 9DD

Telephone (02406) 5314



• Circle No. 249

Successful business?... Yes, with the megamicro

average installed system
less than **£8000** plus VAT

complete with
Hardware including printer
Software including programs
Staff training
Installation & delivery
Support by manufacturer

British built by:
Bytronix Microcomputers Ltd, 83, West Street, Farnham.
Telephone: (0252) 726814

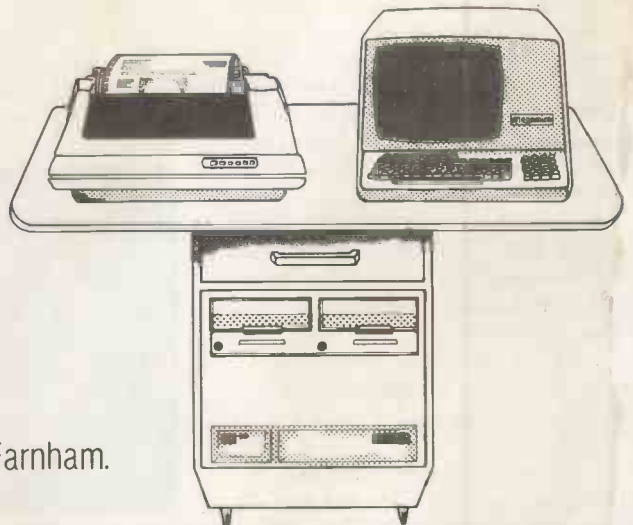

• Circle No. 250

We specialise in big help for buyers of small systems.

Lots of people feel they need help when it comes to choosing and buying a business computer.

That's why they come to NSC Computer Shops.

We are specialists and we have the most experience. So we can give the most expert advice.

We also offer the widest range you could wish to see.

Plus a total back-up including consultancy, software and continuing support. And you get a good deal, price-wise.

South West Technical Products

A middle priced business computer widely used for word processing, and a big time saver on things like mailing lists. NSC have stocks of disc drives, both 8" and 5¼" and memory boards and interface cards, with reductions of up to 40% on some items. Also available are processor cards to upgrade to 6809, and a complete range of 6809 equipment.

Apple

Manchester's first Apple dealer. We will be pleased to demonstrate any of the exciting products which are now available with the Apple, including voice recognition, graphics tablet etc.

Cromemco

Top quality computer systems backed by complete software service for word and data processing. The only microcomputer currently available with RPG II.

Centronic 779 for £779

The most robust low cost printer around. At a special reduced price of £779 while stocks last.

Acorn Atom

Come and try this new budget priced computer at NSC Computer Shops. Kit machine available from £120.

Shop at NSC and get a better deal.

Ring 061-832 2269 for further information.



North Star Horizon

A complete word processing system extendible from 32K-56K RAM, up to four mini disc drives, 4MHz Z80A processor, serial and parallel I/O ports and extended BASIC. NSC have a full range of accounting packages available for this system, which has also proved very popular in educational and industrial applications. You can lease it over a five year period for as little as £25 per week.



Pet

A popular and very reliable small business system used for accounting, word processing, mailing lists and other office tasks. NSC's attractive prices on all models of the Pet make it a very sound investment.

NSC COMPUTER SHOPS

Here to help

NSC Computer Shops, 29 Hanging Ditch, Manchester M4 3ES

UPGRADE TO KANSAS!

No matter who your software supplier you will upgrade your Tandy TRS-80 or Video Genie with Kansas software — simply, it's the best you can buy.

We offer no Wumpus, Tic-Tac-Toe, Calendar or other such rubbish which seems to form the basis of most software lists, but offer professionally produced programs at very sensible prices — and you are not fleeced for postage either!

All our software is recorded twice on each side of the cassette at different levels to accommodate the idiosyncracies of all known cassette systems of both the Tandy and Genie. You even get unheard of full labeling and printed inlay cards — with the title on the spine for easy reference.

We operate a return first class post service and accept orders on Barclaycard or Trustcard, with even an after-hours (cheap rate) telephone service to save you more money. And all our software carries an 'immediate replacement — no quibble' guarantee.

Ask for a copy of the 'Kansas Collection' and you will see what we mean...

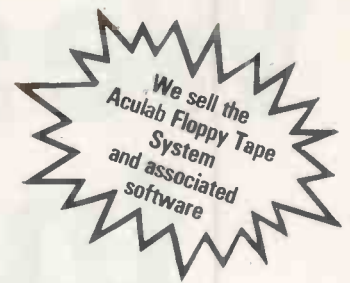

Kansas

Kansas City Systems, Unit 3, Sutton Springs Wood, Chesterfield, Derbys. Tel 0246 850357

• Circle No. 252



centralex

A comprehensive range of Microcomputers Equipment, Peripherals, Software and Services for those who value Professional Standards, Guidance and Continuing Support for Hardware and Software.

CENTRALEX-LONDON LTD
8-12 Lee High Rd, London SE13
Tel: 01-318 4213/4/5/6/7
9.30 am - 5 pm Mon to Fri -
Evenings and weekends by
appointment

APPLE
TEXAS
MICROPOLIS
DIABLO
MICROLINE

PET
OHIO SCIENTIFIC
CENTRONICS
QUME
HITACHI

ITT 2020
CROMEMCO
ANADIX
DEC
LEXICON

EXIDY
MICROSTAR
INTEGRAL
DATA GENERAL
ETC. ETC.

HORIZON
SHUGART
TELETYPE
EPSON

INFORMEX-80 Printer

£399+VAT

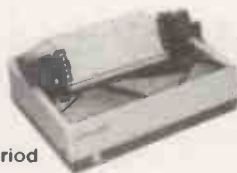

Special offer — for a limited period

For PET, APPLE, EXIDY, TRS80, ETC
A high quality, high speed printer
(125 cps) Upper and lower case letters
plus graphics as standard
Interface and cable for TRS80, PET,
APPLE or RS 232 £69 + VAT
Tractor feed option only £39

ALSO Training, Consultancy, Systems Design,
Programming and Software

PAYROLL - INVOICING - STOCK CONTROL -
SALES/PURCHASE LEDGER - VAT - MEDICAL
RECORDS - EDUCATIONAL & ENGINEERING
PROGRAMMES - HOTEL RESERVATION - ESTATE
AGENTS - BUILDING MAINTENANCE - COBOL -
FORTRAN - ETC.

Maintenance Contracts including stand-by equipment during repair
periods - Free Delivery Nationwide - Terms arranged - Credit Cards and
official orders accepted.



• Circle No. 253

SUPERBRAIN™ PLUS

INTERTEC DATA SYSTEMS* INTRODUCED
THE REMARKABLE SUPERBRAIN AT THE
START OF 1980

now ENCOTEL SYSTEMS LTD.
introduces SUPERBRAIN +
ALL THE STANDARD FEATURES



- * 64K RAM * DUAL Z80 A's *
- * DUAL RS-232 COMMUNICATIONS PORTS*
- * CP/M 2.2 OPERATING SYSTEM *

- + 800K DISC CAPACITY STANDARD (STD QD M/C 700K)
- + 1.5 MB OPTIONAL
- + FAST DISC ACCESS — FIVE TIMES FASTER THAN STANDARD MACHINES
- + KEY REPEAT
- + OPTIONAL TELEX BOARD

SUPERBRAIN +	800K	£2450
	1500K	£2800
* HARD DISCS	10MB	£2640
	32MB	£7900
	96MB	£9900

* (allows up to 255 COMPUSTAR users)

6 month warranty — 1 years maintenance agreement £200

** SOFTWARE **

THE BEST RANGE OF SOFTWARE
new

- * 6502/6800/8080/8085/Z80 ASSEMBLER
- * 8048 ASSEMBLER
- * THE CREATOR BASIC PROGRAM WRITER
- * THE REPORTER BASIC FILE REPORTER
- * SPELLBINDER WORD PROCESSING
- * Demonstrable IBM 3740 EMULATOR (3270 soon)
- * A DBMS WHICH SURPASSES CODASYL DBMS REQUIREMENTS
- * GRAHAM DORIAN BUSINESS SOFTWARE
- * BASIC, COBOL, FORTRAN, PL/I, PASCAL (APL soon)
- * DATA ENTRY SYSTEM AND DATA ENTRY TOOL £75 EACH
- * ASYNC TERMINAL SOFTWARE £75

WHY ARE SO MANY LARGE COMPANIES COMING TO US?

because WE OFFER *fast* DELIVERY, PROFESSIONAL SERVICE
IBM COMMUNICATIONS EMULATORS, SOUND ENGINEERING AND
SOFTWARE EXPERIENCE, COMPETITIVE PRICES *and* backup

Remember
SUPERBRAIN+

IS ONLY AVAILABLE FROM THE ENCOTEL DEALER GROUP

TERODEC MICROSYSTEMS LTD
BOYD MICROSYSTEMS LTD
MAP COMPUTERS LTD
MAP COMPUTERS LTD
MAP COMPUTERS LTD
DIALOGUE TERMINALS LTD
SYSTEMS MICROS LTD
MICROMANAGEMENT LTD
REVALE COMPUTERS LTD
OCEANIC LTD

Reading, Berks (0734) 664345/6
Bushey Heath, Herts (01) 950 0303
Oldham, Lancs (061) 633 3084
Leeds (0532) 445234
Glasgow (041) 204 1297
London (01) 660 0119
Telford, Staffs (0952) 460 214
Ipswich, Suffolk (0473) 4592
Bury St Edmonds, Suffolk (095381) 316
London (01) 488 9751

(0734) 664345/6
(01) 950 0303
(061) 633 3084
(0532) 445234
(041) 204 1297
(01) 660 0119
(0952) 460 214
(0473) 4592
(095381) 316
(01) 488 9751

WORKFLOW LTD
D D M LTD
ENSIGN LTD
KING PIN COMPUTERS LTD
ISIS COMPUTER SERVICES
NICOMTECH LTD
ORCHARD MICROBYTE LTD
BUSINESS CONTROL & DEVELOPMENT
LABTRONICS COMPUTERS LTD
J.R. INSTRUMENTS

Cowden, Kent (034286) 357
Brentwood, Essex (0277) 214168 or 229379
Swindon, Wiltshire (0793) 42615
Stevenage, Herts (0438) 59677
Henley on Thames, Oxon (04912) 77735
Plymouth, Devon (0752) 669801
Rayleigh, Essex (0268) 741271
Cheltenham, Glos Evesham (0186) 831969
London & Kent (09592) 2872
Sanderstead, Surrey (01) 657 7646



Encotel Systems Ltd

530 - 539 Purley Way, Croydon, Surrey

Telephone: 01-686 9687/8

Telex 265605

* WE ARE OFFICAL INTERTEC DISTRIBUTORS *

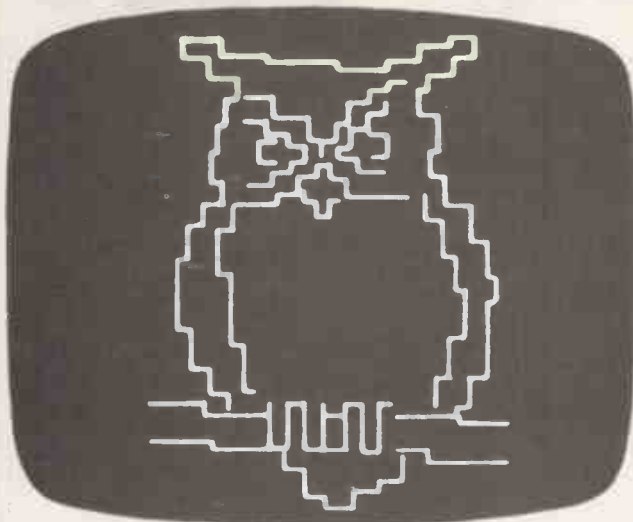

**You lucky Apple II owners-
by adding **Appletel** you
can have the only
PO approved
computer connection**

With Appletel you can link your present Apple II computer direct to Prestel for just £595 plus VAT - which is a major cost saving for a start. Add in these other major advantages and you'll really appreciate what the complete Owl Computer package can do for you!

- ★ Save on telephone bills by storing pages from Prestel on a floppy disc - screen them up on Apple II when you're ready.
- ★ Programme the unit to automatically call up a sequence of pages, and store them for later examination.
- ★ Write your own BASIC programs to process Prestel data as well as send commands to Prestel.
- ★ The full keyboard means you can use Prestel to maximum advantage for sending messages.
- ★ Appletel is now available in colour

For full details on what Appletel can do for you, and the name of your nearest dealer, please phone or write.



Owl Computers

18 Hadham Road, Bishop's Stortford
Herts CM23 2QR
Tel: Bishop's Stortford (0279) 52682

• Circle No. 255

**MICRO SPEECH 2
DOES YOUR COMPUTER
SPEAK TO YOU?**

MICROSPEECH 2 is a stand alone speech synthesizing unit. It converts phonetic code or any ASCII text into a speech output. MICROSPEECH 2 may be interfaced to any computer system because all the computation necessary to synthesize speech is performed by its own dedicated microprocessor. Up to one thousand phonetic characters, representing about one minute of speech, may be assembled in the units internal buffer before it is commanded to speak.

FEATURES

- Runs from phonetic code, giving unlimited vocabulary and simple operating software.
- Optional English to phonetics translator allows operation directly from ordinary text.
- Uses standard RS232/ V24 interface.
- Totally self contained with internal loudspeaker and power supply.
- No need to worry about complex interfacing or support software.

PRICE

Phonetic model £875.00 +

VAT

Phonetic model plus Eng-

lish to phonetics translator

..... £950.00 + VAT

Available from:

COSTRONICS ELECTRONICS 13 Field Heath Avenue,
Hillingdon, Middlesex Uxbridge (89) 38791
TIM ORR DESIGN CONSULTANT
55 Drive Mansions, Fulham Rd, London SW6
(01) 7312077



• Circle No. 256

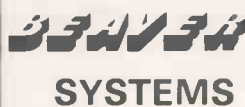

Norlett House
Dormer Road
Thame
Oxon OX9 3UC
Telephone Thame
(084421) 5020 (24 hr)

**YOUR COMPLETE
OHIO SCIENTIFIC SERVICE**

HERE ARE FIVE VERY GOOD REASONS FOR CALLING US -

1. **O.S.I. SYSTEMS**
— including the popular SUPERBOARD II and CHALLENGER 4P as either cassette or disc based systems.
2. **O.S.I. SOFTWARE**
— cassette and disk based software covering a broad spectrum of uses. Some of the cassette based software can also be run on the U.K.101.
3. **BEAVER SOFTWARE**
— Business, educational and entertainment software — professional programs with full listings and documentation. Also available for other systems — especially the U.K.101.
4. **BEAVER PROGRAMMING AIDS**
— including Video Workpads, BASIC workpads, Machine Code Workpads, Cassette Index cards and labels and Blank Cassettes, all available for OSI, U.K.101, and TRS-80.
5. **BEAVER EXPANSION**
— Economy memory expansion using motherboard and slot-in 8K RAM boards, 8K EPROM boards, floppy control board & shortly, PROM Programmer board. Buy as much as you need when you need it.



CALL OR WRITE... NOW!



• Circle No. 257

MICROSYSTEMS'81

EXHIBITION & CONFERENCE

**March 11-13, 09.30-
18.00 daily**

**Wembley Conference
Centre**

Exhibition admission £1.00

**A complete study of
microprocessors in use.**

Microsystems '81 consists of a wide ranging exhibition, together with a three day conference and three one-day microprocessor awareness courses. Together they comprise an invaluable opportunity for those interested in microprocessor applications and the latest developments in microelectronics technology. Take advantage of this unique event to examine and discuss a comprehensive range of microprocessors, peripherals, memory products and personal computers together with the software which accompanies them.

For Conference details write to:
The Conference Administrator
IPC Conferences Ltd, Surrey House,
1 Throwley Way, Sutton,
Surrey SM1 4QQ

For *advance exhibition tickets at £1 each, write to: Microsystems Tickets
IPC Exhibitions Ltd, Surrey House,
1 Throwley Way, Sutton,
Surrey SM1 4QQ

*Please note applications for tickets cannot be accepted after February 23, although tickets will be available at the door price £1. Cheques should be made payable in UK sterling to IPC Business Press Limited.

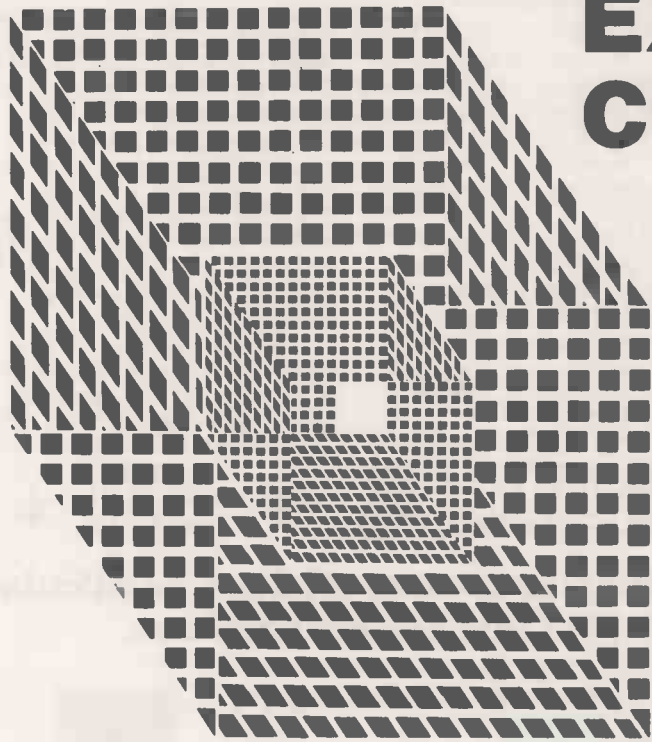

SUMLOCK BONDAIN

makes the decisions easier...



Discover the full professional power of Hewlett Packard's personal computer.

The portable, stand-alone HP-85 personal computer was only the beginning of a total system. By itself, the HP-85 lets you put professional problem-solving power wherever you need it. Because all its features are built into a single unit weighing less than 10 kgs.

And now you can extend the HP-85's power to match your increasing professional requirements. Simply plug in HP's new high-performance printers, plotters and flexible disc systems. In fact, you can add up to 14 peripherals or instruments. It's up to you.

It's your personal computer system. You decide which HP peripherals you need.

Add the HP 2631B printer for high-speed, high-quality printing – with choice of line spacing, character width and density. Add the HP 7225 Graphics Plotter for high-resolution, publication-quality graphics on A4-size paper or film. Add memory with the HP 82900 series of flexible disc drives, each 5¼" disc providing up to 270K bytes of formatted storage. And HP's new enhancement ROMs and modules let you expand to 80K bytes of operating system, without reducing user memory.

See the HP-85 and its new peripherals in action. Getting your hands on so much professional computing power was never so easy.



NEW
* VISICALC + *
available Jan.

...with our latest range of advanced calculator to solve your professional problems.



HP-32E Advanced statistical and scientific calculator. All functions of the 31E plus hyperbolics and their inverses. Full set of 2 variable statistics – means, standard deviations, linear regressions, Fixed, scientific or engineering display modes. 15 addressable storage registers.

£30.46



NEW
HP-34C Advanced programmable scientific calculator. Indirect addressing. Controlled memory varying between 210 program lines and 70 data registers. Innovative SOLVE and INTEGRATE functions. With Continuous Memory to retain data and programs even when switched off.

£79.50

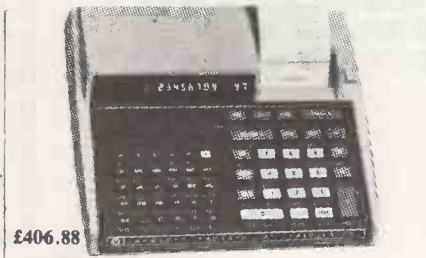

£406.88

HP-67/HP-97 Magnetic card programmable calculators. Pre-recorded application packs covering maths, statistics, electrical engineering, business and finance. 26 data storage registers. 224 merged program lines with up to 3 keystrokes per line. HP-97 is a desk-top model with integrated thermal printer.

£196.87



NEW
HP-38C Programmable financial calculator. Direct solution of rate of return and NPV in discounted cash flow calculations. Interest rates, yields, payments, number of payments etc. Applications in securities trading, leasing, loans and savings. Calendar functions. Programmable facility for individual solutions. With Continuous Memory to retain data and programs even when switched off.

£79.50

HP-38E Lower cost version of HP-38C without Continuous Memory.

HP 38E £66.45



HP-37E Basic financial calculator. Direct and automatic calculation of interest rates and yields, payments, number of payments etc. Applications in leasing, loans, investments etc. Percentage 'retail' and statistical functions.

£41.78

No hidden extras. Every Hewlett-Packard calculator comes complete with: soft, zip-up lined case; owner's and application manuals (plus additional applications book where appropriate); factory-fitted rechargeable cells and recharger (apart from the 41C); two rolls of thermal paper on printing machines. Beyond the standard package, we've a wide range of optional accessories and our comprehensive software support, which gives you a choice of applications packs to really extend your range of ability.



NEW
HP-41C HP's unique expandable calculating system. Advanced 130-function programmable calculator. Full alphanumeric liquid crystal display. Up to 319 registers for data or programs. Add-on extras include Magnetic Card Reader and Printer.

HP41C £168.04
HP82104A £122.76
HP82143A £219.89



NEW **HP-33C** Programmable scientific calculator. 49 lines of program memory. 3 levels of subroutines. 8 addressable storage registers. Integer, fraction and absolute value of a number. With Continuous Memory to retain data and programs even when switched off.

HP-33E Lower cost version of HP-33C without Continuous Memory.

HP33C £48.85
HP33E £44.58

**COMPARE OUR PRICES
WE THINK YOU WILL FIND
THEY ARE THE BEST
AROUND**

SUMLOCK BONDAIN LTD.
Head office: 263-269 City Road, London EC1V 1JX
and at Cannon Street Station, London EC4
Tel. 01-250 0505 Telex 299844

If you need advice, ask for it — WE CAN GIVE IT
Barclaycard/Access, official orders accepted by phone

All prices include postage, packing & VAT
• Circle No. 258

ROCKWELL AIM65 as you like it!

The only micro with a built-in printer.



AIM 65. The original bare-board version as it comes from Rockwell with: 20 col. printer, 20 chr alphanumeric display, 54 Qwerty Keyboard, TTY and dual cassette interfaces, 1K or 4K on-board RAM options, powerful 8K monitor in ROM. This 6502 up based product comes complete with full documentation, fully assembled and tested.

Price: A65-100 (with 1K RAM) £265.00
A65-400 (with 4K RAM) £315.00

AIM 65C. This 'special' packaged system developed by PML, for those of you who wish to limit your hardware involvement to the attachment of the 13 amp plug (we leave it off especially). It comes with 4K RAM, power supply, assembler or basic and desk-top case.

Price: A65-500C (basic) £485.00
A65-600C (assembler) £475.00



DAIM. A complete disk-operating system designed especially for use with the AIM 65, it makes use of the software hooks in the AIM 65 monitor program. The DAIM controller is capable of controlling up to two mini-floppy disk drives which adds up to 160K bytes of read/write memory to the AIM 65. Everything is complete — plug it in and the DAIM is ready to go.

DAIM Controller £388.00
Single-Disk Drive £307.00
Dual-Disk Drive £540.00

AIMEM. A 32K byte self-contained memory system for use with AIM 65. Housed in an attractive aluminium case with an integral power supply separate from the host micro. The system has a transparent refresh and uses the industry standard 4116 device configured in relocatable 4K byte segments.

AIMEM £335.00

VIDEO. Programmable display format of up to 100 char by 20 lines on a Monitor, 48 by 20 on a T.V. Both upper and lower case ASCII characters in ROM. On board display RAM adds up to 4K bytes of RAM to your system as display memory. Designed to operate with the AIM 65 monitor it offers hardware scrolling, programmable cursor, light pen, programmable video format.

A65-VID £196.00



Options:

assembler in ROM	£60.00
basic in ROM	£70.00
power supply	£45.00
acoustic coupler	£200.00
expansion motherboards	A65-KIM £80.00 A65-6800 £135.00

Card Cage	£25.00
Case with psu:	£110.00
Case	£28.00
Thermal Paper	80p
22/44 connector	£7.00
Expansion cable	£10.00

NOTE All prices are subject to change without notice and are exclusive of V.A.T.



**Portable
Microsystems
Limited**

Forby House, 18 Market Place,
Brackley, Northants, NN13 5SF
Telephone Brackley (0280) 702017
Telex Micro 83147

Ask about our similar models using Nascom 1 or 2 microcomputers.

• Circle No. 259

Enter the Computer Age video genie system

12K MICROSOFT BASIC
16K RAM, TV MODULATOR
INTERNAL CASSETTE



£330
+ VAT

£395
+ VAT

80 Columns
70 Lines per minute
Graphics Characters
Interfaces to most
machines Tractor or
friction feed



100's of programs available
TRS-80 level II software
compatible

Mighty Micro Ltd
Neptune House
Sandygate
Burnley
Lancs
Tel: 0282 32209/53629

• Circle No. 260



MINIATURE KEYBOARDS

SPECIAL OFFER

RAPID TURNAROUND
CUSTOM DESIGN IS
OUR SPECIALITY



Apex is manufacturing miniature keyboards in volume for the T.V. and Computer Industries. Substantial cost savings have been made and these are now being offered to the end user in this Introductory Special Offer. Ideal for interfacing to micro based systems via an 8 bit ASCII data bus or a serial 20mA/RS232 port these attractively styled keyboards have all the features of full sized units at a fraction of the cost.

• Miniature ASCII keyboard	MKB01	£40.00
• Cased ASCII Keyboard	MKB01C	£45.00
• Serial Cased Keyboard (20mA)	MKB01CMA	£65.00
• Serial Cased Keyboard (RS232)	MKB01CRS	£65.00
• BCD Encoded Hex Pad	MHP01	£17.95
• Ribbon Cable and Connector	RCC20	£2.50

When ordering serial interfaces please specify Baud Rate.

APEX MICROSYSTEMS LTD 06333 69169
Unit 22 Springrate Industrial Estate
Cwmbran, Gwent

• Circle No. 261

GATE MICROSYSTEMS LIMITED SCOTLAND'S COMPLETE MICROCOMPUTER SERVICE



Announce:

SUP'R'TERMINAL

SUP'R'TERMINAL IS AN 80 COLUMN BY 24 LINE PLUG-IN
COMPATIBLE BOARD FOR THE APPLE II COMPUTER

SPECIFICATIONS

- 80 Columns by 24 lines, upper and lower case; all 128 ASCII characters.
- Upper and Lower case data entry using the APPLE II keyboard.
- Includes an Upper and lower case 5x8 dot matrix ASCII character set, and inverse alpha characters.
- Character set can be user definable
- Includes VBCT™ (video balance circuit) which enables the use of displaying 80 columns on an inexpensive 8 MHz CRT monitor
- Shift Lock Feature
- Works with APPLE PASCAL and APPLE BASIC
- Incorporates PASCAL and BASIC control characters
- ALL monitor-type escapes are valid
- Follows protocols of PASCAL and BASIC operating systems
- Compatible with ALL APPLE II peripherals.
- Effective baud rate greater than 10,000; fast scrolling and clearing
- Synchronous operation with APPLE II
- Can be used with APPLE II communication interface board to act as self contained terminal for time-sharing or other applications.

£245.00
Ex VAT.

GATE MICROSYSTEMS LIMITED
THE NETHERGATE CENTRE, 66 NETHERGATE, DUNDEE
TEL: (0382) 28194

• Circle No. 262

ANGLIA COMPUTER CENTRE

MICROCOMPUTERS FOR BUSINESS,
EDUCATION AND HOME

FOR ALL YOUR BUSINESS, EDUCATION
& LEISURE COMPUTER REQUIREMENTS!!!

ACORN ATOM
APPLE II
TRS-80
SHARP
NORTH STAR
HORIZON
TANGERINE
U.K. 101
NASCOM
VIDEO GENIE

+ PRINTERS &
OTHER PERIPHERALS.

BOOKS**
SOFTWARE*
MAGAZINES**
STATIONERY***
BUSINESS &
INDUSTRIAL
CONTROL

WE ARE HERE!!!

88 St. Benedict's Street
NORWICH NR2 4AB
Tel. (0603) 29652
24hr. Answering Service.

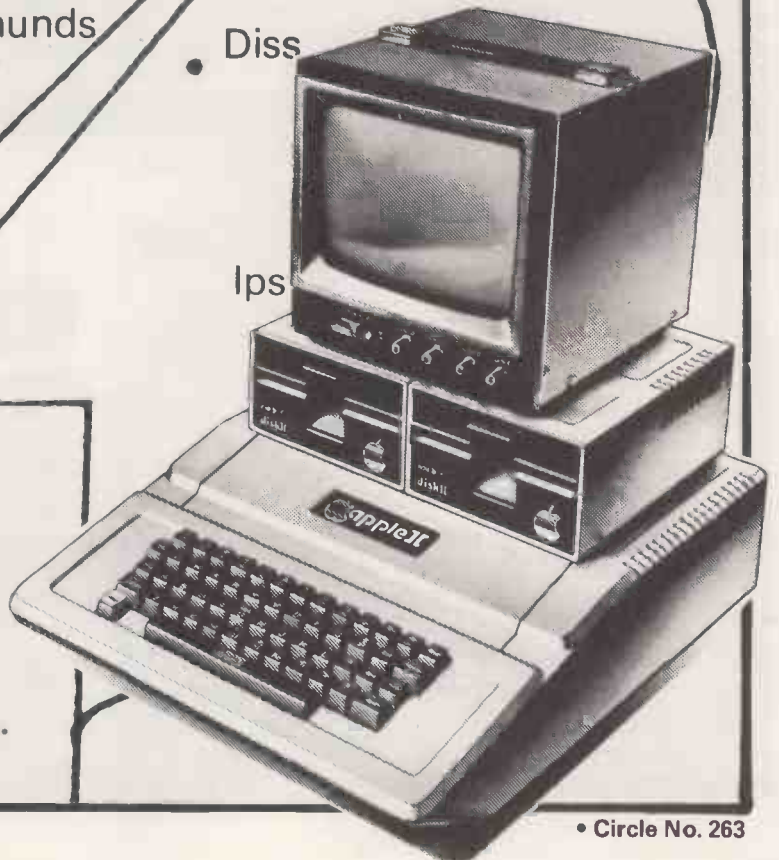
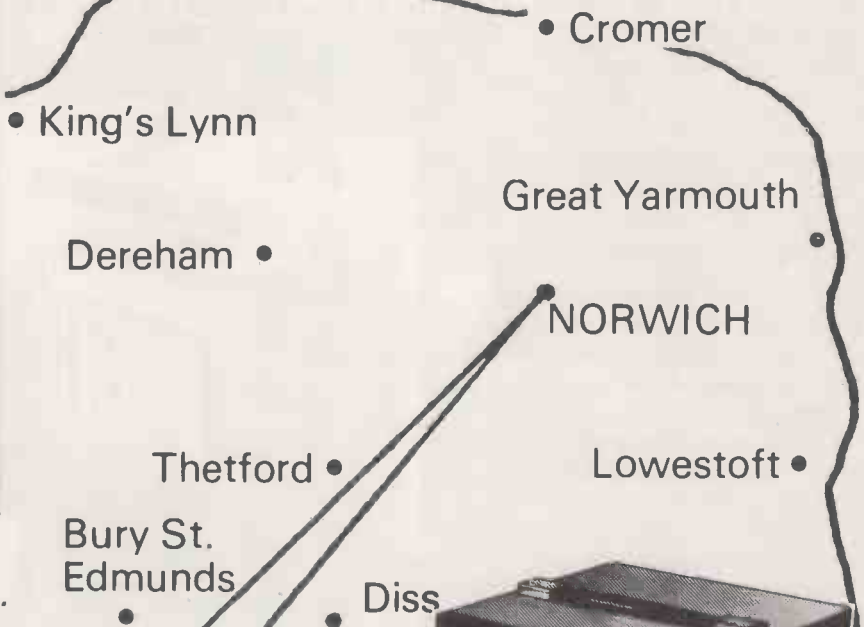

• Circle No. 263

BYTE SHOP

COMPUTERLAND

your specialist Computerstore.

Well-proven systems for the serious user. Our computer stores are staffed by business experts, backed by first class maintenance support. Call in for advice and a demonstration of our range of systems.

Cromemco System Three

The Cromemco buyer is choosing well-proven design, reliability and expandability. Start with a single terminal and grow into a multi-user system as your requirements expand. Excellent Cromemco software includes COBOL, FORTRAN and RPG-II. Ask for a demonstration of the Cromemco hard-disk and talk over with us how your application can be programmed.



North Star Horizon

The reliable and long-established commercial favourite. Ask about our BYTE SHOP-developed packages – Invoicing, Sales and Purchase Ledger, Incomplete Records, Cash-Flow Analysis, Stock Control, etc. And use your Horizon to type perfect letters – it is an excellent word-processor.

Nottingham
92a Upper Parliament Street
Nottingham NG1 6LF
Tel. 0602 40576 Telex. 377389

Manchester
11 Gateway House
Piccadilly Station Approach
Manchester
Tel. 061-236 4737 Telex. 666168

Birmingham
94-96 Hurst Street
Birmingham B5 4TD
Tel. 021-622 7149 Telex. 336186

Glasgow
Magnet House
Waterloo Street
Glasgow Tel. 041-221 7409
Telex. 779263

BYTE SHOP
COMPUTERLAND
– your specialist Computerstore.

London
48 Tottenham Court Road
London W185 4TD
Tel. 01-636 0647

• Circle No. 264

Practical Computing Back Issues

Each month, *Practical Computing* carries at least one hands-on test of a popular microcomputer for use in business, the home, schools and colleges. Each issue contains the kind of information you need — technical data and for the intelligent professional layman, unbiased critical comment on the strengths and weaknesses of each system or service reviewed.

All this makes *Practical Computing* an invaluable source of whys, wherefores, hows, ifs and buts of microcomputing.

Order your back issues now, by simply filling in our Back Numbers order form bound in every issue.

**STOP
PRESS**

PRACTICAL COMPUTING BINDERS AVAILABLE NOW

UK — £4.60 including packing, postage and VAT
Overseas — £5.75 including packing and postage

Send cheques to: *Practical Computing*,
Mr B Paul, General Sales Dept, Room 205
Quadrant House, The Quadrant,
Sutton, Surrey SM2 5AS

October 1978 *

Review 1: Commodore Pet I **Review 2:** VDUs — Computer Workshop CI-64, Strumech Engineering ACT-1. Music on a KIM; Micro v Calculator; VAT accounting complete program Part 1.

November 1978 *

Review: Tandy TRS-80. Projects for KIM: Pet goes to school; VAT accounting complete program Part 2; Complete game program — Mastermind; Software Dynamics Basic compiler review.

December 1978 *

Review: Research Machines 380Z. Choosing your first computer; ITT interview; Complete games programs — Battleships, Racing Cars and Monsters; A microcomputered reservation system.

February 1979

Reviews: Cromemco Z-2D. Low-cost peripherals. Systems for estate agents and doctors; A £1000 payroll system; IBM typewriter conversion Part 2; Complete game program — Warlock Warren.

March 1979

Review: Single-board computers for less than £50 Low-cost stock-control systems; IBM typewriter conversion Part 3; New monthly column — Tandy Forum; Complete game program — NIM.

April 1979 *

Review: North Star Horizon Business accounting systems; Apple II design story Part 1; Computerised school meals; Finance for school computing; Build your own frequency meter; Star Trek game.

May 1979

Reviews: Exidy Sorcerer. Science of Cambridge Mk 14; Printers for less than £1000; Order processing/invoicing packages; Retire with your computer; Apple II design story Part 2; Slalom game.



August 1980



September 1980



October 1980



December 1980

June 1979

Reviews: CompuColor II, Ohio Superboard II; Low-cost word-processing; Computing in a pharmacy; Designing a small business application Part 1; Computer v. Brain; Zombie game.

August 1980

Reviews: Texas Instruments TI99/4; Rair, hard-disc system; Computech sales ledger; Tuscan designer's story part two. Games; Adventure II and Supertank part two; a listing of user groups; MUSE software standards. This and much more including the Software Buyers' Guide.

September 1980

Reviews: Motorola Exorset; Ohio Scientific Challenger. Anagram stock control; Tuscan design story Part III; Personal money management; Naspen word processor; Shape table compiler for Apple II and ITT2020 Special Peripherals Buyers' Guide.

October 1980

Reviews: SuperPet; Vector Graphic MZ System B; Desktop Plan. U.S. Presidential Election Game. Tuscan designer's story, part four. Computer education, Junior Minister interviewed. Chess Game Survey. Winchester technology. Statistics on a micro.

November 1980

Reviews: IBM 5120; Acorn Atom; Compec preview; The Micro revolution; World politics simulation; The future of packaged software; Tuscan Part V; Z 80 Zodiac; ZX-80 Line and the rest of ever popular club pages; Software Buyers' Guide.

December 1980

Reviews: Millbank Systems; Zilog Z-8000; Pearl; The rise, fall and re-birth of Nascom; We probe the micromarket; Software for the Tuscan; Space Intruders; Plus all the ever popular regular features and club pages. Peripherals Buyers' Guide.

PLEASE NOTE ONLY THE ISSUES LISTED ARE AVAILABLE

* Limited Stocks

Fill in the coupon opposite and return it with your remittance to *Practical Computing*, General Sales Dept, Room 205, Quadrant House, The Quadrant, Sutton, Surrey SM2 5AS.

Enter the Computer Age video genie system

12K MICROSOFT BASIC
16K RAM, TV MODULATOR
INTERNAL CASSETTE

£330
+ VAT

£395
+ VAT

80 Columns
70 Lines per minute
Graphics Characters
Interfaces to most machines
Tractor or friction feed



100's of programs available
TRS-80 level II software
compatible

Dealer List

3 Line Computing
ABC Supplies
Advance TV Services
Allen TV Services
Amateur Radio Shop
Anglia Computer Centre
Arden Data Processing

Beaver Computers
Blandford Computers
Briers Bookshop
Buss Stop

Cambridge Microcomputers
Catronics
Cavern Electronics
Computer Business Systems
Computer and Chips
Computerama
Computopia
D B Microcomputers
Derwent Radio
Eiron Computers
Eley Electronics
East Midlands Computer Services
Emprise Ltd
G B Organs & TV
Gemsoft
Kansas City Systems
Kays Electronics
Leisurronics
Maron Microcomputer Services

Matrix Computer Systems
Midland Microcomputers
Microdigital
Mighty Micro
Mighty Micro Ltd
Morrison Computer Centre
MRS Communications
Optelco
C Owens
Q Tek Systems
Radio Shack Ltd
Rebvale Computers
SMG Microcomputers
Tryfan Computers
University Radio Stores
Ward Electronics
Watford Electronics

Hull 445496
Levenshulme 061-431-9265
ShIPLEY 585333
Stoke on Trent 616929
Huddersfield 20774
Norwich 29652
Peterboro' 49577
Leicester 222 55
Littlehampton 22461
Blandford 53737
Middlesbrough 242017
Watford 40698
Newport Pagnell 610625
Cambridge 314666
Wallington 01-669-6700/1
Milton Keynes 314925
Lytham 730033
St Andrews 72569
Bath 333232
Leighton Buzzard 376600
Limerick 42733
Scarborough 65996
Dublin 808575/805045
Leicester 871522
Nottingham 267079
Colchester 865773
St Saviour Jersey 26788
Woking 22881
Chesterfield 850357
Chesterfield 31696
Blackpool 27091
Northampton 890661
Melton Mowbray 812888
Stock on Trent 541743
Beckenham 01-658 7508/7551
Nottingham 298281
Liverpool 227-2535
Basingstoke 56417
Burnley 32209/53629
Swansea 795817
Cardiff 616936/7
Rayleigh 774089
Peterlee 865871
Stevenage 653858
London NW6 01-624-7174
Garboldisham 316
Gravesend 55813
Bangor 52042
Nottingham 45466
Birmingham 021-554-0708
Watford 40588
37774

LOWE ELECTRONICS

Bentley Bridge, Chesterfield Road,
Matlock, Derbyshire. DE4 5LE.

TRADE ENQUIRIES WELCOME



• Circle No. 265

MICROMAS

is now also available
on Superbrain



The MICROMAS complete, *integrated*, business accounting system comprises:
A NOMINAL LEDGER linked to
Stock Control
Invoicing
Sales Ledger
Purchase Ledger
Payroll
Management Accounts
Mailing
Time Recording

For use as a complete system or in module form for any CP/M with Microsoft BASIC or North Star. BASIC from a European and nationwide dealer network trained in system implementation.

MICROMAS is currently available on the following:

Altos
Dynabyte
H.E.A. 3000

I.M.S. Series
North Star Horizon
Vectorgraphic



Contact us for your nearest dealer.

P. R. Daly & Co. Limited

Systems Consultants

Oaklands Gate,
Northwood,
Middx.

Tel. Northwood (09274) 29815 or (01) 868 7284

• Circle No. 266

TCL PASCAL

Standard PASCAL
with P-code interpreter and linker,
following the ISO/BSI working draft.
Compiler operates in two modes:

Resident in RAM—makes
PASCAL as easy to learn as BASIC

Disc mode—with full set of
PASCAL commands.

Many enhancements to standard
PASCAL. Fully validated. Runs in
32K of RAM.

- TCL PASCAL for CP/M and PET is available now
at £120 plus VAT including Manual. Carriage paid.
- TCL PASCAL Manuals are available at £9.50 each.
Carriage paid.

TCL SOFTWARE

We mind our language!

TCL SOFTWARE
59/61 THEOBALD'S ROAD, LONDON WC1.
TEL: 01-405 5240

©TCL PASCAL is copyright of TCL Software. OEM licences available.

®
CP/M

Compatible with all
systems. IBM format on 5"
or 8" discs.

Manual—TCL PASCAL
for CP/M.

Runs on TUSCAN,
TRITON, 380Z, TEI, TRS80
computers.

*
PET

Unique features include
interface to PET BASIC and
clock.

Available now for PET 3032
on 5" disc.

Manual—TCL PASCAL
for PET.

**Available from TCL SOFTWARE and all Commodore
PET dealers now.*

I am interested in the TCL PASCAL compiler. Please send me:

The TCL PASCAL Manual for PET CP/M* at £9.50

The TCL PASCAL Manual and DISC for PET CP/M* at £138.

*Delete as necessary and specify 5" or 8" disc for CP/M

NAME _____

ADDRESS _____

TELEPHONE _____

PC1/81

• Circle No. 267

c s
ca is
cad dis
cadd ddis
caddi addis
caddiscaddis
caddi addis
cadd ddis
cad dis
ca is
c s

OFFICIAL COMMODORE, ACT, AND SHARP DEALERS

Specialists in micro-computer applications



Caddis Computer Systems Ltd

*** LOOK LOW PRICES!! AND PROFESSIONAL SERVICE ***

COMMODORE	RRP	CADDIS
8K PET Graphics Keyboard	425	405
8K PET Business Keyboard	450	425
16K PET Business Keyboard	550	520
32K PET Business Keyboard	695	650
PRINTER 3022	425	405
DISKDRIVE 2040	695	650
CASSETTE DRIVE	55	50
COMPUTHINK		
DISKDRIVE 400K old ROM	795	755
DISKDRIVE 400K new ROM	895	850
DISKDRIVE 800K new ROM	1145	1070
TELETYPE 43	900	825
DECWRITER LA34	925	825
SHARK MZ80K 34K Model (All models available)	599	570

CADDIS INTERFACES Full range for professional and hobbyist applications e.g. IEEE488 to RS232C; PARALLEL I/O; Analogue I/O etc.
SOFTWARE Full range of Business and Education Software by ACT, COMMODORE, H.B., PETSOFTE etc.
DESIGN Our team of professional engineers will design interfaces, software packages, or systems to your requirements.
LEASING facilities available to suitable clients.
DELIVERY arranged by REDSTAR or SECURICOR.
ALL EQUIPMENT CAN BE SUPPLIED MAIL ORDER (Cash with Order Please).

The above is only a selection of the equipment we can supply. Please ring for further details.

72-74, TRINITY LANE, HINCKLEY, LEICS.
TEL. HINCKLEY (0455) 613544

ALL PRICES EXCLUDE VAT & CARRIAGE

• Circle No. 268

Printed Continuous Stationery

we can supply printed continuous forms with your company name and logo plus ex-stock single part listing paper in the following sizes:-

depth x width	(in inches)	depth x width
11 x 9 $\frac{1}{4}$		13 x 9 $\frac{1}{4}$
11 x 9 $\frac{1}{2}$		8 $\frac{1}{2}$ x 11 $\frac{1}{2}$
11 x 10 $\frac{3}{8}$		12 x 8 $\frac{1}{2}$
11 x 9 $\frac{7}{8}$		12 x 9 $\frac{1}{4}$ 60 gsm
11 x 8 $\frac{1}{2}$	★ NEW	12 x 9 $\frac{1}{4}$ 70 gsm
11 x 12		12 x 9 $\frac{1}{4}$ 85 gsm
8 $\frac{1}{2}$ x 12		

multiples in OTC or NCR are available for prices and details telephone:-

David Richards 01-520 8624

David Richards (Printers & Distributors) Ltd 61/63, Hoe Street London E17 4SA

• Circle No. 269

COMPLETE SYSTEMS

**NEW SUPERBRAIN DOUBLE DENSITY £1595
QUAD DENSITY £1995**



Now with CP/M2.2, and increased disc storage. Twin Z80-A 4MHz. *2 Double Density Disc Drives, giving 350/700K storage *64K RAM. *High resolution 12 inch crt. 80 x 24 lines upper/lower case
* 2 RS-232 printer ports.
* CPM 2.2 operating system. *MBasic, Cobol, Fortran, Pascal, Word Processing and Accounts packages available.
Dealer Enquiries Invited.

TRS-80 MODEL II £1999



NOW WITH CP/M 2.24 EXTENDED DENSITY

State of The Art Second Generation Computer. Over 10,000 already sold in USA. 8 slot bus ensures expansion of hard discs and other peripherals. 76 Key professional keyboard, self test on power up. TRSDOS and Level III Basic Standard. CP/M available as option, making a wide range of accounting, educational, scientific and word processing packages instantly usable. Nationwide service through 180 Tandy Stores and Computer Centres.

**NEW TRS-80 MODEL 1 48K SYSTEM
NEW LOW PRICE £1095**



WITH DUAL DISC DRIVES. NEW GREEN SCREEN VDU, WITH ROCK STEADY DISPLAY. REDESIGNED 32K EXPANSION INTERFACE WITH TROUBLE FREE DISC OPERATION. TWO 40 TRACK TEAC DISC DRIVES. COMPLETE WITH CABLES. TRIDATA SALES. PURCHASE. INVOICING, PAYROLL. PACKAGES AVAILABLE.

LOW COST WORD PROCESSOR I

BASED ON TRS-80 LEVEL 2 16K, CASSETTE RECORDER, ELECTRIC PENCIL SOFTWARE, UPPER/LOWER CASE MOD, PRINTER INTERFACE AND OKI DOT MATRIX PRINTER. COMPLETE READY TO GO £895 FREE MAILING LIST PROGRAM.

WORD PROCESSOR II

SAME AS ABOVE BUT WITH 48K, 2 DISC DRIVES AND RICOH DAISY WHEEL PRINTER. £2195

WORD PROCESSOR III

BASED ON SUPERBRAIN COMPUTER SHOWN ABOVE. WITH RICOH PRINTER AND "MAGIC WAND" THE ULTIMATE IN WORD PROCESSING. LETTERS AUTOMATICALLY FORMATTED WITH ADDRESSES FETCHED FROM SEPARATE FILE. COMPLETE SYSTEM. £2950.

INVOICING, STOCK CONTROL, SALES LEDGER, PURCHASE LEDGER, PAYROLL AVAILABLE FOR ABOVE COMPUTERS. FROM £250 PER PACKAGE.

Prices quoted above do not include VAT. Phone or call for further details or demonstrations.

PRICES QUOTED ABOVE DO NOT INCLUDE VAT. PHONE OR CALL FOR FURTHER DETAILS OR DEMONSTRATIONS.

PRINTERS

**60 CHARACTERS PER SECOND
NEW LOW PRICE £1095**

RICOH RP-1600 THE FASTEST DAISY WHEEL PRINTER. FAST, heavy duty commercial DAISY WHEEL printer, with high quality printout, coupled with low noise necessary for office environment. Nationwide service by NEXOS. 90 day warranty provided at your premises.

124 char: upper/lower case. * 10/12 chars: per inch giving 136 or 163 columns. * 15 inch wide friction platen. * Top of the form, BOLDING, underline, and host of other features. * Centronics type parallel interface as standard. Options: serial interface £60 * PET interface £65 * APPLE interface £75.

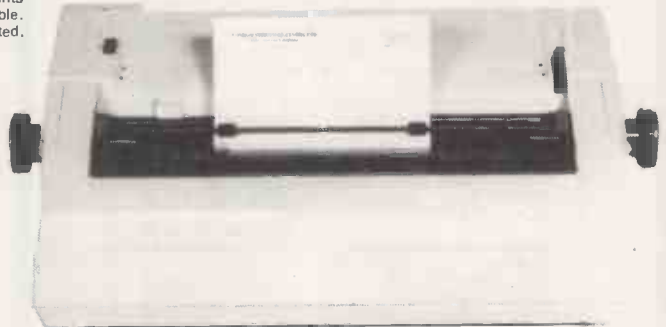

**ANADEX DP-8000
NEW LOW PRICE £449.**

Fast 112 Characters per second. * Both RS-232, and Centronics Parallel interfaces built in * Upper/lower case £ sign.



**NOW WITH £ SIGN
NEW LOW PRICE £399**

OKI MICROLINE 80/132. The quiet printer you can live with. The quietest Dot Matrix available. 40,80, or 132 cols per line. * excellent print quality * 3-way paper handling: Letterheads, Fan-fold, or Paper Rolls * Graphics * Ideal for software written for large 132 col printers * Continuous rating printing day in and day out * Centronics parallel standard. Options: RS-232, PET, APPLE. Dealer Enquiries invited.

NEW MAXI ANADEX WITH GRAPHICS £895

Takes up to 13.5 inch wide paper * Upper/lower case with decenders * £ sign * 132 or 175 chrs/line with double width printing * Fast 150 CPS bi-directional logic seeking printing * Heavy duty print head giving 650 million chrs print life * serial, Parallel and Current Loop interfaces built in * Host of other features found on printers costing twice as much.



LONDON COMPUTER CENTRE LIMITED

**43, GRAFTON WAY, OFF TOTTENHAM COURT ROAD, LONDON W1
TEL: 01-388 5721 OPENING HRS: 11-7 MON-FRI, 12-4 SATS.**

MICRO SYS LTD
58 HIGH STREET
PRESCOTT
MERSEYSIDE TEL: 051 426 7271

NOTHERN DEALERS

HORIZON SOFTWARE LTD
REGENT HOUSE
16 WEST WALK
LEICESTER LE1 7NG TEL: 0533 556550

• Circle No. 270



Pete & Pam Computers

Microcomputer hardware & software
Specialists in Applefare

Peter & Pam Fisher

Products for APPLE (A) PET (P) and TRS-80 (T) at a
FAIR PRICE!

MICROSOFT

Z-80 SOFTCARD (A) £175.00

A true Z-80 microprocessor including CP/M and Micro-
soft BASIC.

ASSEMBLY LANGUAGE
(A + Softcard) £162.95, (T) £49.95

BASIC COMPILER
(A + Softcard) £192.95, (T) £99.95

COBOL (A + Softcard) £359.95

EDITOR/ASSEMBLER PLUS (T) £15.95

FORTRAN (gen. true mach. code)

(A + Softcard) £99.95, (T) £49.95

LEVEL III BASIC (T) £26.95

ADVENTURE (A + T) (disk int or fp) £14.95

TYPING TUTOR (int. tape) (A) £7.95, (T) £ 8.95

OLYMPIC DECATHLON (A + T) £14.95

Test your reflexes in 10 events — uses High Res graphics!

PERSONAL SOFTWARE

VISCALC (P) £96.95, (A) £75.00

CCA DATA BASE MANAGEMENT

(T) £37.95, (A) £49.95

(P) £12.95

6502 BASIC ASSEMBLER

GAMES — all on tape (int or ft)

CHECKER KING (A, P + T) £10.95

BRIDGE PARTNER (P + T) £ 8.95

GRAPHICS PACKAGE (P) £ 8.95

ELECTRONIC PAINTBRUSH (T) £ 8.95

PERIPHERALS PLUS

VERSAWRITER (A 32K) £124.95

Drawing tablet — allows colour, hi-resolution graphics
to be drawn free-hand or traced. Enlarge, shrink, rotate
images. Includes applications software — calculate
distances, add electronics symbols, 5 sizes of U & L case
text, and much more!

HIGH TECHNOLOGY

INFORMATION MASTER (A) £73.95

The most flexible and reliable data manager available,
written by the authors of "The Cashier" and "DBMS".
Performs mathematical calculations. Powerful, but easy
to use.

DATA BASE MANAGEMENT SYSTEM (A) £49.95

Design your own system for manipulation of large
amounts of data, and print formatted reports arranged
as you choose.

DATA MASTER (A) £49.95

NEW! A powerful accessory to use with either "Inform-
ation Master" or "DBMS", adds immense versatility
to both. Re-define files, merge data, enter new calcul-
ations, and more!

ORDER SCHEDULER (A) £73.95

Helps you to maintain records and schedule shipment of
orders from your stock. Makes sales accounting easy.
Written by the author of "The Cashier", optional Inter-
action with "The Cashier" produces reports of projected
sales and demand. Remarkable!

MOUNTAIN HARDWARE

EXPANSION CHASSIS (A) £319.95

8 more slots for your APPLE with separate power supply
to allow optimum use. This long-awaited product is
made to Mountain Hardware's high standards. Compat-
ible with all peripherals.

MUSIC SYSTEM (A) £259.95

Generates the sound of any musical instrument — real
or imagined! Digital synthesizer with sixteen voices —
sophistication previously only available on mainframe.
Graphical input using light pen (provided) paddles or
keyboard. Includes membership of User's Club.

M & R ENTERPRISES

SUP-R-TERMINAL (A + video monitor) £195.00

The best of 80 x 24 video cards! Shift/lock mod. 128
U & L case 5 x 8 dot matrix ASCII characters and User
definable char. sets.

UTILITIES

MACRO SCREEN EDITOR (A Int or FP disk) £19.95

PASCAL PAPER TIGER GRAPHICS (A) £22.95

ENHANCED TIGER GRAPHICS

(PAGE 1 OR 2) (A disk) £22.95

VISILIST (A) (formula/grid location of

Visicalc files) £10.95

APPLE-DOC (A) (change any listed element) £12.95

PROGRAM LINE EDITOR (A disk Int or FP) £18.95

HIGHER TEXT (A disk Int or FP) £16.95

(def. own colour text)

PLEASE ADD 15% V.A.T. TO YOUR ORDER —

POSTAGE IS FREE

ASK US FOR OUR FULL CATALOGUE

BUSINESS - GAMES — UTILITIES — FIRMWARE

WE WANT TO BE YOUR MAILORDER SUPPLIER.

IF YOU KNOW WHAT YOU WANT — AND DON'T

WANT TO PAY AN INFLATED PRICE —

GIVE US A CALL. WE'LL TRY OUR BEST!

TEL. 01-677-2052 (24 hours) 7 days a week.

98 MOYSER ROAD, LONDON SW16 6SH.

POST OFFICE GIRO A/C NO. 585 6450

• Circle No. 271

EMG MICRO SYSTEMS

EMG 01-688 0088

We are specialists in complete installations
tailor made for your business requirements:

WORD PROCESSING SYSTEM	£1999
INVOICE AND CUSTOMER SYSTEM	£2999
LEADS AND SALES SYSTEM	£2999
INSURANCE AGENT SYSTEM	£2999
ESTATE AGENCY SYSTEM	£2999
COMPLETE BUSINESS SYSTEM	£3999

We are MAIN LONDON SORCERER STOCKISTS

Sorcerer Systems Desk, Mains Stabilisation,
Cooling Fan, Memory Upgrades, Servicing

RENTAL

Plug-in 315K Disk Drive	£31 per week
Video Disk Unit	£ 5.59 per week
Daisywheel WP System	£14.99 per week
WP Correspondence Course, Link your Sorcerer to a mainfram or other Sorcerer	

Full software list on request

6 COPIES OF SOURCE MAGAZINE ONLY £5

Write to Dept PCA, EMG Microcomputers Ltd,
30, Heathfield Road, Croydon, Surrey.

• Circle No. 272

Enter the Computer Age video genie system

12K MICROSOFT BASIC
16K RAM, TV MODULATOR
INTERNAL CASSETTE

£330
+ VAT



£395
+ VAT

80 Columns
70 Lines per minute
Graphics Characters
Interfaces to most
machines Tractor or
friction feed



100's of programs available
TRS-80 level II software
compatible

Photo Electric Software
459 London Road
Sheffield 2
Tel: 0742-53865

• Circle No. 273

SYSTEM 4000 EPROM EMULATOR/PROGRAMMERS



P4000 PRODUCTION EPROM PROGRAMMER

This unit provides 'simple, reliable' programming of up to 8 EPROMs. It has been designed for ease of operator use — a single 'program' key starts the blank check — program — verify sequence. Independent blank check and verify controls are provided along with mode, pass/fail indicators for each copy socket and a sounder to signal a correct key command and the end of a programming run. Any of the 2704/2708/2716 (3 rail) and 2508/2758/2516/2716/2532/2732 EPROMs may be selected without hardware or personality card changes. 2 year warranty. Price **£545 + VAT**:

VM10 VIDEO MONITOR

This compact, lightweight Video Monitor gives a clean crisp picture on its 10" screen. Suitable for use with the EP4000, SOFTY and other systems. 12 month warranty. Price **£88 + VAT, carriage paid**.

MODEL 14 EPROM ERASERS



MODEL UV140 EPROM ERASER

Similar to model UV141 but without timer. Low price at **£61.50 + VAT, postage paid**.

EP4000 EPROM EMULATOR/PROGRAMMER

The microprocessor based EP4000 has been designed as a flexible, low cost, high quality unit for emulating and programming all the popular NMOS EPROMs without the need for personality cards, modules or hardware changes. Its software intensive design permits selection of the 2704/2708/2716 triple rail EPROMs and the 2508/2758/2516/2716/2532/2732 single rail EPROMs for both the programming and emulating modes.

The video output (T.V. or monitor) for memory map display in addition to the built-in Hex LED display, for stand alone use, is unique in this type of system. This, with the double function 28 key keypad, powerful editing features, powered down programming socket, buffered tri-state simulator cable and 4k x 8 data RAM gives you the most comprehensive, flexible and compact systems available today.

2 year warranty. Price **£545 + VAT**:

MODEL UV141 EPROM ERASER

- 14 EPROM capacity
- Fast erase time
- Built-in 5-50-minute timer
- Safety interlocked to prevent eye and skin damage
- Convenient slide-tray loading of devices
- Available Ex-Stock at **£78 + VAT** Postage Paid
- Add **£6** to order total for next day delivery by DATAPOST.

PLEASE NOTE OUR NEW ADDRESS/TELEPHONE NUMBER

GP INDUSTRIAL ELECTRONICS LTD,

UNIT 6, BURKE ROAD, TOTNES INDUSTRIAL ESTATE,
TOTNES, DEVON.

TELEPHONE: TOTNES (0803) 863360 (Sales) / 863380 (Technical Service)
DISTRIBUTORS REQUIRED — EXPORT ENQUIRIES WELCOME

SOFTY SYSTEM

EX-STOCK

Low cost card 2704/2708

emulator/programmer features:

- Direct output to T.V. • High speed cassette interface • On card EPROM programmer • Multifunction Keypad • 1K monitor in 2708 • 1K RAM • 128 byte scratchpad RAM • 22 in/out ports • Access at card edge to all buses • 1K EPROM EMULATION
- Direct memory access for fast data transfers • Editing facilities, including — data entry/deletion, block shift, block store, match byte, displacement calculation • Supplied with Zif socket, simulator cable and comprehensive manual

SOFTY Kit of parts **£100 + VAT**

SOFTY Built & tested **£120 + VAT**

SOFTY Built power supply **£20 + VAT**

P&P IS INCLUDED IN ALL PRICES

Add **£6** to order total for next day delivery by DATAPOST.



SOFTY CONVERSION CARD

Enables SOFTY to program the single rail EPROMs, 2508/2758/2516/2532. Selection of device type and 1K block are by pcb slide switches. Programming socket is zero insertion force. Easy connection to SOFTY with the DEP Jumper supplied. Built and tested: **£40 + VAT, postage paid**.

SOFTY PRINTER

- 40 column electrosensitive printer • 5x7 dot matrix • print sizes • Push button hex print-out of SOFTYs RAM, EPROM or inter-cursor contents • On card PSU • Selection of bytes per line. Built and tested **£145 + VAT, postage paid**.

EX-STOCK EPROMS

	1-9	10-24	25 up
2716 (single rail)	9-00	8-00	7-35
2708	4-80	4-30	3-90

ADD VAT AT 15% — POSTAGE PAID

WRITE OR TELEPHONE FOR DETAILS ON ANY OF OUR PRODUCTS

• Circle No. 274

Intex DATALOG LTD COMPUTERS

MICROPAY-200 £195.00 + VAT

Micropay-200 is a complete payroll System designed to run on a COMMODORE 32K PET microcomputer, interfaced to dual floppy disk drives and a printer.

The System provides:

1. Weekly/monthly payslips
2. Summary page of all payments and deductions that month
3. Summary page of all payments and deductions for the tax year to date
4. Weekly/monthly cash analysis slip for all cash payments made
5. Monthly summary of all payments and deductions
6. Year end summary of all payments and deductions

STOCK CONTROL 3750

Stock Control 3750 is a complete stock control system designed and written to meet the needs of a small business.

It will accommodate up to 3747 stock items and runs on a COMMODORE PET micro-computer interfaced to a printer and COMPU/THINK disk drives.

The System incorporates programs to:

1. Set up a Supplier file.
2. Set up Stock files.
3. Copy Data files.
4. Insert/delete stock records.
5. Insert/delete supplier records.
6. Update/display stock file.
7. Update/display supplier file.
8. Print stock list.
9. Print supplier list.
10. Print reorder report.
11. Print stock movement report.
12. Print stock valuation report.

And perform other useful routines.

Stock Control 3750 is fully protected from misuse and can easily be used by someone with no knowledge of computers or their operation.

The System costs £195.00 + V.A.T. and this price includes a full back-up and advisory service from INTEX DATALOG.

FOR FULL SPECIFICATION WRITE TO:
INTEX DATALOG LTD, DEPT PC1280
EAGLESCLIFFE IND. EST., EAGLESCLIFFE
CLEVELAND TS16 0PW. TEL: 0642 781193

MAIL ORDER SERVICE

BARCLAYCARD - MAIL ORDER - ACCESS

ITEM	TOT. INC.	
	PRICE	VAT
*** DUSTCOVERS		
PET - ALL MODELS	5.75	6.90
T/743 PRINTER	5.75	6.90
ANADEX DP8000	3.50	4.35
CBM 3040 DISK	3.50	4.35
CBM 3022 PRINTER	3.99	4.80
COMPUTHINK DISK	3.00	3.75
ACCOUSTIC COVER FOR CBM 3022 PRINTER		
*** 5 1/4 DISKETTES IN FREE CASE	49.00	62.00
BASF	35.00	40.83
ACCUTRACK	30.00	35.08
LIBRARY CASE	3.50	4.60
*** BLANK CASSETTES		
C15 (PER 10)	4.00	5.75
C60 (PER 10)	6.00	8.05
*** CONNECTORS		
USER/IEEE PORT	1.30	1.78
CASSETTE PORT	.99	1.43
USERPORT CDVER	2.50	3.16
MALE 'D' PLUGS	2.80	3.16
FEMALE 'D' SOCKETS	3.50	4.31
'D' CONNECTOR COVERS	2.50	3.16
*** RIBBONS		
TELETYPE 43	7.72	9.17
ANADEX DP8000	2.75	3.45
ANADEX DP9500/1	15.00	18.40
CBM 3022	2.75	3.45
QUME (FABRIC)	4.25	5.18
QUME (CARBON M/S)	4.50	5.45
QUME (CARBON S/S)	5.00	6.04
DAISY WHEELS		
QUME SPRINT 2	6.50	7.76
*** PROGRAMMERS TOOLKIT		
*** SPECIAL OFFER		
OLD ROMS 8K	65.00	75.90
NEW ROMS 8K	65.00	75.90
NEW ROMS 8/16/32K	45.00	52.90

PROKIT 1

PROKIT 1 - PROGRAMMERS AID.
ADDS THAT TOUCH OF PROFESSIONALISM TO EVERY PROGRAM YOU WRITE.
NUMERIC INPUT ROUTINES - AUTOMATICALLY ADD LEADING AND TRAILING ZERO'S AND RESPOND ONLY TO NUMERIC KEYS AND DECIMAL POINT.
GENERAL INPUT ROUTINES - SET THE LENGTH OF FIELD REQUIRED. SPECIFY WHICH CHARACTERS YOU WANT PET TO RESPOND TO AND ALL OTHERS WILL BE IGNORED.
DATE INPUT ROUTINE - THE PROGRAM WILL NOT CONTINUE UNTIL YOU HAVE ENTERED A VALID DATE.
STRING SEARCH ROUTINE - FINDS A MATCHING SUBSTRING WITHIN A A STRING ENABLES YOU TO USE ON . . . GOTO WITH ANY CHARACTERS, NOT JUST NUMBERS.
SCREEN ROUTINES - CAN STORE SCREEN DISPLAYS IN MEMORY AND RETRIEVE THEM IN A FLASH - SUPER FOR MENUS AND GAMES!
PROKIT 1, DEFINITELY THE BEST THING FOR PROGRAMMERS SINCE THAT OTHER KIT! AVAILABLE ON DISK OR TAPE, READY TO INCORPORATE IN YOUR OWN PROGRAMS.
PRICE £40.25 INC. VAT AND POSTAGE

Intex

• Circle No. 275



Some new introductions by the Midlands Computer Centre...

We celebrate our first birthday with news of new introductions available from the Micro Computer Centre.

NEW

HORIZON

NEW

CROMEMCO

In addition to Nascom and Commodore micro computers

PERIPHERALS

(Excluding printers)

Sharp Cassette Decks. Crofton 10" Cased Monitors.

PRINTERS

Nexos Ricoh RP 1600 Daisy Wheel Printer. Diablo Daisy Wheel Printer. Nascom Micro Imp, Dot Matrix Plain Paper Printer. Centronics Dot Matrix. Anadex Dot Matrix. Newbury Laboratories Dot Matrix Impact Printer.

ADD-ONS FOR NASCOM

Input/Output Board. PIO Kit. Counter Timer Kit. UART Kit. (Colour Board Programmable Character Generator Board. Floppy Disc System (Single Drive) available in September). Nas-Pen Text editor. ZEAP 2.0 in EPROM or on Tape. Nas-Sys 3 Enhanced version of Nas-Sys 1. Nas-Dis - Disassembler. Debug - Dynamic Debugger.

BITs & PCs

Tool Kit. Port Probe. Hex Key Pad.

WILLIAM STUART

Colour Graphics for Nascom 1 & 2.

MERSEYSIDE NASCOM USER GROUP

ROM/EPROM Board for Nasbus.

EXTRAS

Henry's EPROM Burner. Antex Soldering Irons & Bits.

SOFTWARE

Northstar. CAP-CPP. Cromemco. Petsoft. Supersoft. Nascom Games.

BOOKS

Very full range of books on 6502, Z80, Languages, Interfacing, Introductory books and games and General Programs.

MAGAZINES

Personal Computer World. Computing Today. Practical Computing. Educational Computing. Liverpool Software Gazette. Printout.

**ASK ABOUT
THE KENILWORTH CASE**

The "Kenilworth" Case. Microtype Case. Veroframe.

**BUSINESS & LEISURE
MICROCOMPUTERS**

Castle Interface.

Business & Leisure Micro Computers

16 The Square, Kenilworth, Warwickshire CV8 1EB. Tel: (0926) 512127

• Circle No. 276

PRACTICAL COMPUTING January 1981

KGB MICROS LIMITED

THE PROFESSIONAL ORGANISATION OFFERING
HARDWARE AND SOFTWARE PLUS FULL CLIENT SUPPORT
WHO WISH TO MAKE YOUR BUSINESS OUR BUSINESS

SUPERBRAIN™



THE MICRO COMPUTER THAT HAS
THE BEST PRICE/PERFORMANCE
RATIO.

£1495 (64K RAM)

MICROLINE 80

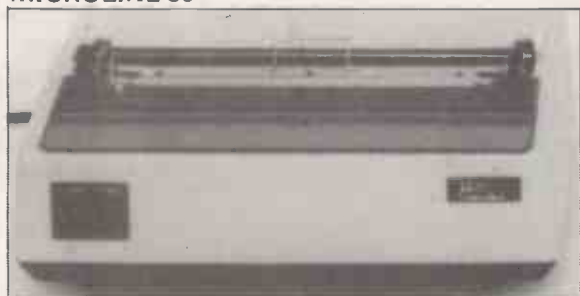

THE EFFICIENT BUSINESS SYSTEM
SUPERBRAIN

+
MICROLINE 80 PRINTER

£1795

INDIVIDUAL PRICE £500.00

DIABLO 630



THE COMPLETE WORD PROCESSING
SYSTEM
SUPERBRAIN

+
DIABOLO 630 PRINTER

+
THE PROVEN 'WORD STAR' PACKAGE

£2995

INDIVIDUAL PRICE £1675.00

SOFTWARE SUPPORT

- * KGB offer a wide range of standard software — FORTRAN, COBOL, BASIC, PASCAL.
- * KGB will customise our software packages to meet your unique requirements — Invoicing £95, Sales Ledger £235, Purchase Ledger £235, Nominal Ledger £235, Payroll £335.
- * KGB will design and implement software to suit your business needs.

**KGB Micros Ltd., 88 High Street, Slough, Berkshire.
Tel: Slough 38581/38319**

Superbrain is the registered trademark of Intertec Data Systems. Prices exc. VAT.

• Circle No. 277

commodore PET PACK software DIRECT FROM audiogenic

(WE MANUFACTURE THEM)

The Commodore range of Petpack Software is big and getting bigger! At the moment there are over 60 Petpacks and new programs are being added all the time. Here at Audiogenic we hold stocks of every Petpack and GD series disc, ready for immediate despatch.

For the Businessman we have programs for Stock Control, Filing, Accounts, Payroll, a very powerful Word Processor, and more! For Educational applications we have programs to aid in the tuition of Languages, Physics, Maths, English, Pet Programming, Statistics, etc. For the Scientist or Engineer we have programs on Mechanics of Materials, Harmonic Analysis, Circuit Design, Drawing Load and Die Design, Statistical Analysis, Geometry and Algebra, to mention but a few. Then for the Programmer, there is a selection of Programming Aids on cassette and disc. And, of course, there are the Games Petpacks! Fun for all the Family! There are at present 12 cassettes in the Treasure Trove series, with over 40 different games in all. The Arcade series has 6 games which will be familiar to those of you who frequent pubs, clubs or amusement arcades. The games are PET versions of those popular pastimes like the addictive 'Space Invaders' or the universe-encompassing 3D Startrek.

Get our catalogue for the exciting details.

We also supply for your PET

CONNECTICUT MICRO

A range of analog to digital conversion equipment with up to 16 inputs for the collection of information. Temperature probes and software provided, all at prices starting at around £90.00. Also a range of IEEE to RS232 converters which are addressable and uni- or bi-directional. Prices start at £65.00

A B COMPUTERS VISIBLE MUSIC MONITOR

This unit is absolutely phenomenal. It actually displays music (staves, notes, signature etc.) on the screen and plays it at the same time. It will handle 4 part harmonies and you can add or delete notes with simple keyboard commands. It's a sort of musical word processor. Ideal for computer music freaks, whether rock, classical or budding "Stockhausens". Comes complete with notes, 8 bit D/A converter and some beautiful pieces of music inc. Maple Leaf Rag and some Bach. Excellent value at £39.50 inc. VAT plus 25p P+P.

PROMINICO X-DOS

This little ROM makes all the difference to using disks, as it gives a range of commands like MENU, which displays the disc directory in the form of pages. It does not lose the program currently resident in the PET, and does away with initialisation. It also incorporates a screen dump to printer, disk copy and scratch routines. See our catalogue for further details.

JCL EPROM BURNERS

An essential device for programmers wishing to incorporate their programs into ROMs. Comes complete with software. Another nice little number from this company is the TURNKEY ROM set, which is suited to business software writers and users. It will load from disk a program as soon as you power up - also features a "BULLET PROOF" input routine. See our catalogue for the details of this versatile little beauty.

BOOKS

Over 15 titles from



SIGMA, MOE and COMPUTABITS. All the titles have been selected with the PET user in mind, and the range includes books on PASCAL, GRAPHICS, PROGRAMS, IEEE BUS, CIRCUITS, HARDWARE, etc. Don't forget the PET/CBM Personal Computer Guide at £9.25 plus £1.00 p+p.

BASIC 4 and DOS 2 CONVERSION

BASIC 4 gives your new ROM PET all the commands of the new 80 column PETS. DOS 2 goes in your disk drive and is necessary when using BASIC 4 or may be used on its own to get rid of initialisations every time you use a disk. Both sets are priced at £43.70 inc. VAT + 50p P+P each.

ACCESSORIES

SOUND BOARDS, DISKS, CASSETTES, ROMS, DISK HOLDERS, PETSET (GETS YOU OUT OF CRASH), DEMAGNETISER, RIBBONS see catalogue for full details.

Now 22 issues of this superb magazine.

All back copies available £3.50 each plus 25p post + package.



P.O. Box 88 Reading, Berkshire,
Tel: (0734) 595269 24 Hour.

• Circle No. 278



FOR PET, SUPERBOARD, UK101, NASCOM.

- COMPLEX EFFECTS AND MUSIC
- USES INCREDIBLE AY-3-8910
- COMPLETELY BUILT, SIMPLY PLUGS IN
- BASIC OR MACHINE CODE
- BUILT IN AMP & SPEAKER + STEREO
- INCLUDES 2 8 BIT I/O PORTS
- COMPATIBLE WITH OTHER EXPANSIONS
- FREE DEMO PROGRAM + INSTRUCTIONS

Send for free information leaflets.

£43

N.B. 8T28 buffers (Superboard/UK101) next 6502 @ £3.00 per pair if required. + VAT EX STOCK

SOON
AVAILABLE!!
PHONE, WRITE FOR DETAILS.

EPROM Programmer for Superboard/UK101.
Peripheral board 24 I/O lines for relay driving etc., etc.

SUPERBOARD II 50Hz → £159 + VAT
610 EXPANSION £159 + VAT
CD3P FLOPPY DISC £285 + VAT
BASE 2 800Mst PRINTER £359 + VAT

Microcases £26. 2114L 300ns RAM 8 for £22 5V 3A power supply for Superboard £15. Vision Modulator, high quality, £4.50. Sound Modulator to match £3.75. 40pin ribbon cable. 40pin DIP. 40pin PCB suit Breadboard £4.50. Prototype Breadboard for Superboard/UK101 comprehensive, labeled bus £5.50. Bus extender to take 610 & peripherals £4.95. Header plugs. 40pin F2 50. 40pin sockets £0.40. 8T28 buffers £1.50 ea. AY 3 18910 sound chip £8.25. Joystick mechanisms £9.95. Blank DATA cassettes £5.25 for 10. Black discs 5 1/4" £3.25. PLEASE ADD VAT TO THE ABOVE PRICES. ORDERS UNDER £10 ADD 50p p+p. Trade enquiries welcome.

Esaricomp

57 PARANA COURT, SPROWSTON,
NORWICH NR7 8BH
0603 416352



• Circle No. 279

Original Software for Pet Users

**** D.S.L. BASIC MANAGER ****

- Stores up to 9 programs simultaneously in RAM
- Call and execute any program under menu control
- No interference with normal Basic operation
- Many additional uses to the ingenious

PRICE — Cassette + Full Documentation £12.50

*** D.S.L. WORD PROCESSOR ***

- Full menu control of all functions
- Text entry from keyboard or saved tape file
- Copy/Relocate/Delete/Auto-centering/Justification
- Screen edit/Auto-search replace function
- Print format control via text embedded characters
- Versions for PET or RS232 Printer (Please state type)

PRICE — Cassette + Full Documentation £20

INTERTEC SUPERBRAIN D/D £1995 + VAT
INTERTEC SUPERBRAIN Q/D £2400 + VAT
MICROSOFT MBASIC 5.1 £150 + VAT

When ordering either program please state whether new or old RAM machine.
Prices include VAT and Postage.

DRAGON SYSTEMS LIMITED
54 Mansel St., Swansea, W. Glam.

• Circle No. 280

PRACTICAL COMPUTING January 1981

New, low, low prices on memories!!!

Compare our prices before you buy elsewhere! All devices are brand new, factory prime, full spec. and fully guaranteed!

MEMORIES

	1+	50+	100+
2114 L 450NS	225p	200p	175p
2114 L 300 NS	250p	225p	195p
4116 150 NS	375p	350p	325p
4116 200 NS Ceramic	250p	225p	195p
6514 (TC 5514P) 1k x 4			
CMOS RAM 450 NS	550p	525p	495p

EPROMS

2708 450 NS	395p	375p	350p
2716 Single 5V 450 NS	595p	550p	495p
2532 Single 5V 450 NS	1995p	1695p	1495p

LINEARS

ICL 7106 CPL	575p	525p	475p
LCD 106 3 1/2-digit			
LCD Display	575p	525p	475p
NE 555P	18p	17p	16p
723	33p	30p	28p

All prices exclude p&p and VAT. Please refer to 'Ordering Information' before ordering.

DON'T DELAY — BUY TODAY — SUCH LOW PRICES DON'T LAST FOR EVER!!!

NEW ASTEROIDS IN SPACE!!! EXCITING, ENTERTAINING SOFTWARE FOR THE APPLE II and APPLE II PLUS!!

If you liked 'Invaders' you'll love ASTEROIDS IN SPACE by Bruce Wallace! Your spaceship is travelling in the middle of a shower of asteroids. Blast the asteroids with lasers, *but beware* — BIG ASTEROIDS FRAGMENT INTO SMALL ASTEROIDS! The Apple game paddles allow you to rotate your spaceship, fire its laser gun, and give it thrust to propel it through endless space. From time to time, too, you'll encounter an alien spaceship whose mission is to DESTROY YOU so you'd better destroy it first! High resolution graphics and sound effects add to the arcade-like excitement this program generates. RUNS ON ANY APPLE II WITH AT LEAST 32K AND ONE DISK DRIVE!

ON DISKETTE ONLY **£14.95**

NEW 6809 S-100 SINGLE-BOARD COMPUTER

- * Meets IEEE S-100 Standard!
- * Uses Motorola's Powerful MC6809 CPU!
- * 4K, 8K, 16K ROM!
- * 2K RAM!
- * ACIA, PIA, 8080 Simulated I/O!
- * RS — 232 Handshake!
- * Selectable BAUD Rates!
- * Manual includes: 11" x 7" Schematic, Parts List, User Notes, Software Listings and MORE!

Bareboard only, £491 (plus £1 p&p)
CPU (6809) £24.50!
ADSMON; Monitor (2716) £25!

ONLY **COMPLETE BOARD ASSEMBLED AND TESTED, £250!**
(plus £2 p&p)

NEW! SUPER MUSIC MACHINE KIT!

AT LAST — an affordable kit that can be PROGRAMMED TO PLAY ANY SONG OR GROUP OF SONGS! Instead of a nightmare of numerous ICs and special expensive Bipolar ROMs, the SUPER MUSIC MACHINE uses a SPECIAL MASK PROGRAMMED COMPUTER CHIP, one CMOS gate and the most popular erasable EPROM, the 2708/2716 series. BASIC KIT includes drilled, plated and screened PC board and ALL components except the EPROM and 12V transformer. The basic kit will play short renditions of 25 tunes through its 7 WATT AMPLIFIER SECTION. Add an optional ROM and any tune programmed will be played. If you have the equipment to program 2708 EPROMS, we supply full information on programming your own music!

FEATURES:

- * Basic kit contains 25 short tunes in the main IC!
- * Will address external ROM for up to 1,000 MORE NOTES per ROM! (ROM is not included)
- * Operates on 12V AC or 12V DC @ 500mA. (Using unit on 12V DC and with optional ROM requires 9V bias battery, not included).
- * 7 watts of audio power will drive 8 or 16 ohm speakers or horn speakers (not included).
- * DIP switches not included.
- * 'NEXT TUNE' provision steps sequentially through all tunes.
- * Tune address can be wire jumper selected or board is designed to take DIP switches.
- * PITCH, VOLUME and TEMPO are all adjustable.
- * SPECIAL 'CHIME' SEQUENCES can be activated regardless of tune address to provide for multiple doorbell applications.
- * All tunes consist of electronic musical notes played one at a time. There are no chords or harmony sound to the music.
- * STEP-BY-STEP ASSEMBLY INSTRUCTIONS provided.
- * Large number of PREPROGRAMMED ROMS with popular and classical tunes readily available. Send SAE for list and prices.

ONLY £16.95 for basic kit (plus p&p 60)

SAMS BOOKS AT LOWEST PRICES

COMPUTER BOOKS

Microcomputer Primer (2nd Edition)	NEW £7.17
Microcomputers for Business Applications	£5.37
The Howard W. Sams Crash Course in Microcomputers	NEW £10.50
Fundamentals of Digital Computers (2nd Edition)	£5.97
Getting Acquainted with Microcomputers	£5.37
How to Buy & Use Minicomputers & Microcomputers	£5.97
Computer Graphics Primer	NEW £7.77
TEA: An 8080/8085 Co-Resident Editor Assembler	NEW £5.37
6502 Software Design (Book 1)	£5.70
(Book 2)	£5.97
BASIC Programming Primer	£5.37
DEBUG: An 8080 Interpretive Debugger	£3.75
How to Program Microcomputers	£5.37
Computer Dictionary (3rd Edition)	NEW £7.17
Boolean Algebra for Computer Logic	£3.95
Computers & Programming Guide to Scientists & Engineers (3rd Edition)	NEW £9.57
Microcomputer Interfacing with the 8255 PPI Chip	£5.37
Programming & Interfacing the 6502, with Experiments	NEW £7.17
TRS-80 Interfacing	NEW £5.37
Z-80 Microcomputer Design Projects	NEW £7.77
Z-80 Microprocessor Programming & Interfacing — Books 1 and 2	
(Book 1)	£6.97
(Book 2)	£7.77
Interfacing and Scientific Data Communications Experiments	£3.95
Introductory Experiments in Digital Electronics and 8080A	
Microcomputer Programming and Interfacing	
(Book 1)	£7.77
(Book 2)	£7.77
Microcomputer — Analog Converter Software and Hardware Interfacing	£5.70
The 8080A Bugbook: Microcomputer Interfacing and Programming	£6.30
The S-100 and Other Micro Buses	£3.95
The Cheap Video Cookbook	£3.75
TV Typewriter Cookbook	£5.97
Using the 6800 Microprocessor	£4.77
Z-80 Microcomputer Handbook	£5.37
8085 Microcomputer Design	NEW £5.97
COOKBOOKS	
TTL Cookbook	£5.70
Active-Filter Cookbook	£8.97
TV Typewriter Cookbook	£5.97
CMOS Cookbook	£6.97
The Cheap Video Cookbook	£3.75
IC Converter Cookbook	£8.37
IC Op-Amp Cookbook (2nd Edition)	£8.97

MICROCHIPS AT MICRO PRICES!

INTERFACE

LINEAR	
MC1488	90p
MC1489	90p
OM8123	125p
75150	125p
75154	125p
75182	195p
75322	250p
75324	325p
75325	325p
75361	350p
75365	295p
75451	50p
75491/2	75p
8T26	155p
8T28	175p
8T95	175p
8T97	155p

DISPLAYS

FND500	80p
FND510	80p
FND567	125p
DL704	85p
DL707	85p
MV57164	225p

CPU'S

6502	695p
6504	750p
6505	750p
6800	645p
6802	925p
6809	2450p
8080A	425p
8085A	1095p
Z80	700p
Z80A	900p
Z8001	12500p
X8002	9500p

MEMORIES

2114 300 NS	275p	2716 5V 450 NS	995p
4116 200 NS	250p	2532 32K 450 NS	2995p
4116 150 NS	395p	2564 64K (8K x 8)	
4315 (4k x 1) CMOS		450NS 28-pin	£120
RAM 450 NS	995p		
6514 (1k x 4) CMOS			
RAM 450 NS	795p		

UARTS

AY-5-1013A	325p	DEVELOPMENT	
AY-3-1015D	398p	MODULE	
IM6402 IPL	425p	Z8000 DM	1099p

BIPOLAR PROMS

All are identical and equivalent types — we reserve the right to substitute any make.

256 bit (32 x 8) 18-pin tri-state

MB7051/27S09/7603/5600/6331/74S288/82S123 395p

256 bit (32 x 8) 16-pin open collector

MB7056/27S08/7602/5600/6330/74S188/82S23 395p

1K (256 x 4) 16-pin tri-state

MB7052/74S287/TBP14S10/93427/82S129/7611/6301 395p

1K (256 x 4) 16-pin open collector

MB7057/74S387/TBP14SA10/93417/82S126/7610/6300 395p

2K (512 x 4) 16-pin tri-state

MB7053/93446/82S131/7621/6306 495p

2K (512 x 4) 16-pin open collector

MB7058/93436/82S10/7620/6305 495p

4K (1024 x 4) 18-pin tri-state

MB7122/74S476/93453/82S137/7643/6353/27S33/3625/5626 995p

SUPPORT DEVICES

6520	495p
6522	695p
6532	895p
6551	1095p
6810	375p
6820	360p
6821	325p
6845	2350p
6850	295p
6852	350p
8212	210p
8214	450p
8216	210p
8224	275p
8226	225p
8228	425p
8251	475p
8253	995p
8255	445p
8257	895p
8259	950p
MC 144 12VL	797p
Z80 P10	595p
Z80 CTC	595p
Z80A P10	695p
Z80A CTC	695p
Z80 DMA	1995p
Z80A OMA	2495p
Z80 S10/1	2995p
Z80 S10/0	3495p
Z80 S10/1	2995p
Z80 S10/1	3495p
Z80 S10/2	2995p
Z80 S10/2	3495p

KEYBOARD

ENCODER	
AY-5-2376	795p

EPROMS

1702A	450p
2708 450 NS	425p

CHARACTER GENERATOR

RO-3-2513 UC	450p
--------------	------

BIPOLAR RAMS

27LS00	995p
93A19DC	1125p

FLOPPY DISK CONTROLLERS

FD1771 B-01 S/D Inverted Bus	2995p
FD1791 B-01 D/D Inverted Bus	4995p

THE NEW GI COMPUTER SOUND CHIP

The amazing AY-3-8910 is a fantastically powerful sound and music generator, perfect for use with any 8-bit micro processor. Contains 3 tone channels, noise generator, 3 channels of amplitude controls, 16-bit envelope period control, 2 parallel I/O, 30/A converters plus much more. All in 40 pin DIP. Super easy to interface to the S-100 or other Buses.

ONLY £8.50 + VAT, including FREE reprint of BYTE '79 article! Also, add £2.25 for 60-page data manual.

"Perhaps the next famous composer will not direct a 150-piece orchestra but, rather, a trio of microcomputers controlling a bank of AY-3-8910s." BYTE July '79.

NEW! SPECIAL OFFER!

4K CMOS RAM (1K x 4) 450 NS
ONLY £5.50
The TIC 5514P from Toshiba, CMOS equivalent of the 2114!

- * Lower Power Dissipation
- * 10pW/BIT (TYP.) at 3.0V (STANDBY)
- * 10uW/BIT (TYP.) at 5.0V (OPERATING)
- * Data Retention Voltage 2V to 5.5V
- * Single 5V Power Supply
- * 18 PIN Plastic Package
- * Full Static Operation
- * Three State Output
- * Input/Output TTL Compatible
- * Fast Access Time 450NS.

Toshiba's TC5514P (industry type 6514) is a full static read write memory organised as 1024 words by 4 bits using CMOS technology. Ultra low power dissipation means it can be used as battery-operated portable memory system and also as a non-volatile memory with battery back-up. Operates from a single 5V power supply with static operation, hence no refresh periods and a much simplified power supply circuit design. Three state outputs simplify memory expansion for minimum data retention voltage is 2V, the battery back-up system needs only simple circuit. Toshiba's original C2MOS technology also means wide operating and noise margins. The TC 5514P is moulded in a dual-in-line 18 pin plastic package 0.3 inch in width.

Ordering information. Unless otherwise stated, for orders under £50 add 50p p&p. Add 15% VAT to total (no VAT on books). All devices are brand new, factory prime and full spec and subject to prior sales and availability. Prices subject to change without notice. Minimum telephone order using ACCESS is £10. If ordering by post with ACCESS, include name, address and card no. written clearly. Please allow 4/6 weeks delivery on books.

Dept. PC5
Unit 9/10, 1st Floor, E Block,
38 Mount Pleasant,
London WC1X 0AP.
Tel: 01-278 7369
Telex: 895 3084



• Circle No. 281

AIM 65 PLUS EVERYTHING!

THAT'S CUBIT

EVERYTHING
ROCKWELL

- * AIM 65
- * BASIC
- * Assembler
- * FORTH
- * PL-65
- * 19" rack industrial version

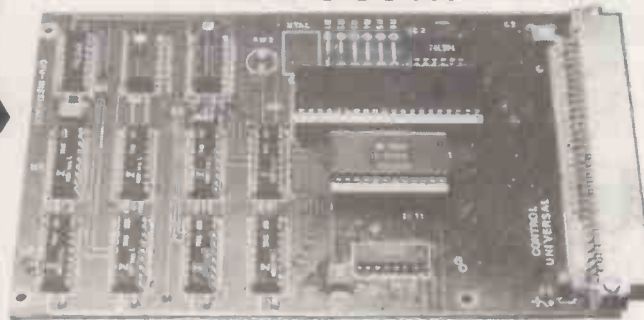

EVERYTHING
ACORN

- * 8K RAM, 8K EPROM memory card
- * PROM programmer
- * 16K memory card, CMOS RAM/EPROM
- * Colour VDU card
- * Floppy disk controller
- * 1 or 2 disk drives
- * 19" rack mounting
- * Accounting system
- * Word processor

FOR £75

Unplug the 6502, plug in Cubit, replace the 6502 — it's that simple.

- * ADDS 4K RAM to give AIM 8K total
- * ADDS 4K EPROM socket
- * ADDS an additional VIA to give a total of 32 i/o lines
- * ADDS an interface to all Acorn Eurocards
- * Can be used as a stand-alone computer.

all available from:

CONTROL UNIVERSAL LTD,
11-15 Bush House, Bush Fair, Harlow, Essex. tel Harlow (0279) 31604

• Circle No. 282

HAVE YOU A TRS-80? THEN MICRO-80 IS FOR YOU

A monthly magazine full of articles and programs just for the TRS-80. Written by enthusiasts for enthusiasts MICRO-80 is now available in this country. Fill in the coupon and send £1.50 for your sample copy.

To: MICRO-80 (U.K. SUBSCRIPTION DEPT.) 24 WOODHILL PARK, PEMBURY,
TUNBRIDGE WELLS, KENT TN2 4NW

PLEASE SEND MY COPY OF MICRO-80 — I ENCLOSE MY CHEQUE/POSTAL ORDER FOR £1.50
(SINGLE COPY RATE)

NAME

ADDRESS

.....

.....

PC1/81

• Circle No. 283

Wilkes Computing

**Exclusive Suppliers of G.R.[®]
DEC PDP 11 Computer Systems
comprising:**

- * 1.25 M Byte CDC Floppy Drives
- * 8 inch 10 M Byte Winchester Disks
- * 96 MB CDC Disk Drives
- * TSX Multi Tasking, Time Sharing
- * Word Processing
- * DBL Commercial language/RSX 11-M
- * All DEC Terminals

[®] General Robotics Inc.

For further details contact:

Wilkes Computing

Bush House, 72 Prince Street, Bristol BS1 4HU. Tel: (0272) 25921. Telex 449205.

• Circle No. 284

...British S100 BOARDS.....

(MANUFACTURED IN THE U.K. TO IEEE BY

INTERACTIVE DATA SYSTEMS)

IDS SBMC	Single Board Micro-computer, Z80A CPU, 4MHz operation (can be jumpered to operate at 2MHz if required), 1K RAM, sockets for up to 32K EPROM, TWO SERIAL PORTS.	KIT £178 A&T £235
IDS 16K SRAM	4MHz Static RAM using low power 2114 chips.	KIT £174 A&T £198
IDS 8K SRAM	4MHz Static RAM using low power 2114 chips	KIT £ 98 A&T £114
IDS DFDC	Double/single density, double/single sided Floppy Disc Controller, up to 4 drives.	KIT £177 A&T £198
IDS SFDC	As DFDC but single density only	KIT £109 A&T £140
IDS PCI 10	Parallel Control Interface with: 8 channels relay-isolated output, 8 channels opto-isolated input, four 8 bit D/A converters, Eight 8 bit analogue inputs, 8 bits input, 8 bits output at TTL	KIT £195 A&T £223
IDS Z80 CPU	Z80A CPU board, 4 MHz operation	KIT £ 84 A&T £105
IDS TERM 40	Active Termination Board	KIT £ 25 A&T £32.50
IDS 7M.BD	7 slot Mother Board, including power connector. (Excludes S100 connectors)	Each £16
IDS 15M.BD	As 7M.BD but 15 slot.	Each £ 24
S100 CONN	S100 edge connectors	Each £2.90
DP 8000	Anadex dot matrix printer, RS232 interface.	Each £495
CATALOGUE	More details of the above products and others.	FREE

Please add 15% VAT to all prices.

MAIL ORDER ONLY

.....Mendip Computers..

67 BATH ROAD, WELLS, SOMERSET, BA6 3HS. TEL: WELLS (0749) 75249

• Circle No. 285

FOR ALL YOUR MAIN REQUIREMENTS
FROM ONE SUPPLIER

Clearsons Ltd.

0252-518022/518717

Continuous Stationery — all types pre-printed including letterheads. Listing Paper — all sizes.

Continuous labels — plain and printed.

Printer ribbons, Pet etc., 3M Data Recording Products

ACCO Continuous Stationery filing systems

NOW AVAILABLE EX-STOCK

Plain listing paper in the following sizes: —

11 x 8½, 11 x 9, 11 x 9¼, 11 x 9½, 12 x 9¼

All best quality white bond, tear off sprockets

STILL ONLY £14.00 per box of 2000 sheets

add VAT + carriage of £3.50 per box.

5 or more carriage FREE.

WE CAN ALSO PRINT CONTINUOUS FORMS

WITH YOUR NAME & ADDRESS ETC

PLEASE RING FOR FREE QUOTE

Floppy Discs, 100% error free, 5¼" from £22.50 per box of 10

Digital Cassettes with Library Case, 10 min £4.70 per 10

12 min £4.00 per 10, 30 min £5.30 per 10

Add VAT and £1.00 post and packing per order.

HAVE YOU BOUGHT A COMPUTER FOR YOUR BUSINESS?

Then let Clearsons Software Ltd provide the package to suit you.

Please ring for quotation: 0252 581022.

Clearsons Ltd.

LYNWOOD HOUSE 1 CAMP ROAD FARNBOROUGH
HAMPSHIRE GU14 6EN TEL 0252 518022

• Circle No. 286

IBM SELECTRIC GOLFGALL PRINTERS

AND

INPUT, OUTPUT 735 TYPEWRITERS

PRINTERS FROM £195.00

735 TYPEWRITERS FROM £245.00

WIRING AND COMMISSION TO SUIT

ACULAB INTERFACE £ 48.00

ACULAB INTERFACES EX STOCK £155.00

ALSO AVAILABLE IBM 71, 72, 82 typewriters

Full workshop facilities for rebuilds and servicing.

Keyboard ASCID-ASCII, 10-12 pitch, language

conversions undertaken.

11", 13", 15" platen lengths, split platens pin feed

platens. Operational keylever repeats fitted on request.

Full IBM range of 10-12* pitch heads including language,

symbol and metric.

Language keybuttons blue or grey.

WE BUY SELL OR EXCHANGE ALL IBM SELECTRIC TYPEWRITER MODELS

FOR FURTHER DETAILS PHONE STUART KIRBY OR LOUIS BAKER

KEYTRONICS

SAUL LODGE SAUL GLOUCESTER GL2 7JE
TEL. 0452 740 612

PRICES EXCL VAT @ 15%

& CARRIAGE & PACKING

CALLERS BY APPT ONLY PLEASE

• Circle No. 287

A GREAT DEAL FROM 6 NASCOM DEALERS

and guaranteed after-sales service

BUILT FLOPPY DISC SYSTEM FOR NASCOM 1/2 FROM £395+VAT

It's here at last. A floppy disc system and CP/M. **CP/M SYSTEM.** The disc unit comes fully assembled complete with one or two 5¼" drives (FD250 double sided, single density) giving 160K per drive, controller card, power supply, interconnects from Nascom 1 or 2 to the FDC card and a second interconnect from the FDC card to two

drives, CP/M 1.4 on diskette plus manual, a BIOS EPROM and new N2MD PROM. All in a stylish enclosure.

Nascom 2 Single drive system. £450 + Vat
 Nascom 2 Double drive system £640 + Vat
 Nascom 1 Single drive system. £460 + Vat
 Nascom 1 Double drive system £650 + Vat
 Additional FD250 drives £205 + Vat

D-DOS SYSTEM

The disc unit is also available without CP/M to enable existing Nas-Sys software to be used. Simple read, write routines are supplied in EPROM. The unit plugs straight into the Nascom PIO.

Single drive system £395 + Vat
 (please state which Nascom the unit is for)

Certain parts of the CP/M and D-DOS disc systems are available in kit form. Details available on request.



ENCLOSURE FOR N2+5

The Kenilworth case is a professional case designed specifically for the Nascom 2 and up to five additional 8" x 8" cards. It has hardwood side panels and a plastic coated steel base and cover. A fully cut back panel will accept a fan, UHF and video connectors and up to 8 D-type connectors. The basic case accepts the N2 board, PSU and keyboard. Optional support kits are available for 2 and 5 card expansion.

Kenilworth case £49.50 + Vat
 2-card support kit £7.50 + Vat • 5-card support kit £19.50 + Vat



INTERFACE ENHANCING UNIT

The Castle Interface is a built and tested add-on unit which lifts the Nascom 2 into the class of the fully professional computer. It mutes spurious output from cassette recorder switching, adds motor control facilities, automatically switches output between cassette and printer, simplifies 2400 baud cassette operating, and provides true RS232 handshake.

Castle Interface Unit .. £17.50 + Vat

EPROM EXPANSION

The Nasbus compatible EPROM board accepts up to 16,2708 or 2716 EPROMs. It has a separate socket for the MK36271 8K BASIC ROM for the benefit of Nascom-1 users. And for Nascom-2 users, a wait state for slower EPROMs. The board also supports the Nascom Page Mode Scheme.

EPROM Board (kit) £55 + Vat
 EPROM Board (built & tested) £70 + Vat

A-D CONVERTER

For really interesting and useful interactions with the 'outside world' the Milham analogue to digital converter is a must. This 8-bit converter is multiplexed between four channels - all software selectable. Sampling rate is 4KHz. Sensitivity is adjustable.

Typical applications include temperature measurement, voice analysis, joystick tracking and voltage measurement. It is supplied built and tested with extensive software and easy connection to the Nascom PIO.

Milham A-D Converter (built and tested) £49.50 + Vat

PROGRAMMER'S AID.

For Nascom ROM BASIC running under Nas-Sys. Supplied in 2x2708 EPROMs. Features include: auto line numbering; intelligent renumbering; program appending; line deletion; hexadecimal conversion; recompression of reserved words; auto repeat; and printer handshake routines. Price £28 + Vat.

DUAL MONITOR BOARD. A piggy-back board that allows N1 users to switch rapidly between two separate operating systems. Price (kit): £6.50 + Vat.

BASIC PROGRAMMER'S AID.

Supplied on tape for N1/2 running Nas-Sys and Nascom ROM BASIC. Features include auto line number, full cross-reference listing, delete lines, find, compacting command, plus a comprehensive line re-numbering facility. Price: £13 + Vat.

PROM-PROG MKII.

2708 (multi-rail) and 2716 (single-rail) EPROM programmer kit controlled by N1/2 PIO. Supplied with comprehensive software for use with Nas-Sys. Price: £25.95 + Vat.

NASCOM-2 Microcomputer Kit £225 + Vat
 NASCOM-1 Microcomputer Kit £125 + Vat
 Built & tested £140 + Vat
 IMP Printer. Built & tested £325 + Vat

All prices are correct at time of going to press.

All the products are available while stocks last from the Nascom dealers below. (Mail order enquirers should telephone for delivery dates and post and packing costs.) Access & Barclaycard welcome.

BITS & PC'S
 4 Westgate, Wetherby, W. Yorks.
 Tel: (0937) 23744
BUSINESS & LEISURE MICROCOMPUTERS
 16 The Squire, Kenilworth, Warks.
 Tel: (0926) 512127.

ELECTROVALUE LTD.
 680 Burnage Lane, Burnage,
 Manchester M19 1NA.
 Tel: (061) 432 4945.
 28 St Judes, Englefield Green,
 Egham, Surrey TW20 0HB.
 Tel: (0784) 33603. Tlx: 264475.

TARGET ELECTRONICS
 16 Cherry Lane, Bristol BS1 3NG.
 Tel: (0272) 421 196
INTERFACE COMPONENTS LTD.
 Oakfield Corner, Sycamore Road,
 Amersham, Bucks.
 Tel: (02403) 22307. Tlx: 837788.

HENRY'S RADIO
 404 Edgware Road, London W2.
 Tel: (01) 402 6822.
 Tlx: 262284 (quote ref: 1400)



• Circle No. 298

video genie

BRITAIN'S BEST BUY
IN PERSONAL COMPUTERS?

— It Only Needs A Plug

- * 16K Ram. — 12k Microsoft Basic in Rom
- * TRS-80 Level II Compatible
- * 100's of Programs Available
- * Self-Contained Power Supply
- * Integral Cassette. Plus into TV or Monitor
- * Ideal for Business, Education, + Leisure
- * Includes Demo Cassette with 5 Programs. + 3 Manuals and Leads

Options.

Sound Unit fitted when ordering £15 + VAT
Lower Case Characters fitted when ordering £55 + VAT

VG System Expansion

Expansion Box	£150
Floppy Tape	£165
Disc Drive	£250
Sound Synthesiser	£ 55
Colour Graphics	THA
Eight pen	£16.50

Epson TX 80B Printer	£349
Printer Interface	£ 35
\$100 Ram Card 16K	£135
\$100 Ram Card 32K	£175
Monitor 9" B/W	
Professional Quality	£ 79
All + VAT	

Programs

Space Invaders (Cassette) with Sound	£13.00
Othello Game (Cassette)	£ 9.25
Music Master (Cassette)	£14.95
Stock Control	£17.00
Text Edit Word Processor (Cassette)	£15.00
All + VAT	

Books

TRS-80 Machine Language from the ground up	£ 8.50
The Easy Way to Programming in Basic	£ 5.00
Erom Erasers	
Low Cost	£34.00
High Speed	£89.00 + VAT

Memory Bargains

2708 Eproms	£ 3.50
2716 Eproms	£ 7.95
2732 Eproms	£18.50
2532 Eproms	£18.50
2114 Rams 300ns	£ 2.70
4116 Rams 200ns	£ 2.95
All + VAT	

Q-Tek Systems Ltd



2, Daltry Close, Old Town, Stevenage, Herts
Tel: (0438) 65385

24-hour Despatch
Stock Permitting

• Circle No. 289

COLLECT YOUR V.A.T. FROM INFRA LTD.

EPROMS

1702A =	4.25
2708k =	5.50
2716k =	12.50
2532k =	28.50

RAMS

21141 =	2.50
4116-2 =	3.50
4118-4 =	19.50
4334-4 =	8.50

A FEW ITEMS TO INDICATE OUR PRICE-CUT

6502—£8 Z80—£8 6845—£10 6809—£12 SFF96364E—£9 AY5-2376—£9

WHOLE RANGE MORE ON TRADE REQUEST

LS Series

74LS00	.18	74LS73	.33	74LS155	.72	74LS245	2.50
74LS01	.18	74LS74	.30	74LS156	.72	74LS247	1.09
74LS02	.18	74LS75	.40	74LS157	.57	74LS248	1.09
74LS03	.19	74LS76	.27	74LS158	.57	74LS249	1.09
74LS04	.20	74LS78	.27	74LS160	1.09	74LS251	.96
74LS05	.22	74LS83	.78	74LS161	.69	74LS253	.92
74LS08	.20	74LS85	.81	74LS162	1.16	74LS257	.92
74LS09	.22	74LS86	.27	74LS163	.69	74LS258	.92
74LS10	.20	74LS90	.57	74LS164	1.06	74LS259	1.39
74LS11	.20	74LS91	.97	74LS165	.72	74LS261	4.50
74LS12	.20	74LS92	.69	*74LS166	1.65	74LS266	.87
74LS12	.37			74LS168	1.71		
74LS14	.65	74LS93	.60	74LS169	1.71	74LS273	1.70
74LS15	.20	74LS95	.81	74LS170	1.72	74LS279	.57
74LS20	.20	74LS96	1.16	74LS173	.81	74LS283	1.09
74LS21	.20	74LS107	.32	74LS174	.97	74LS289	4.50
74LS22	.20	74LS109	.32	74LS175	.97	74LS290	.91
74LS26	.20	74LS112	.32	74LS181	2.77	74LS293	.91
74LS27	.20	74LS113	.32	*74LS168	2.75	74LS295	1.30
74LS28	.22	74LS114	.32	74LS189	2.08	74LS298	1.16
74LS30	.20	74LS122	.69	74LS190	.86	*74LS348	1.39
74LS32	.26	74LS123	.72	74LS191	.86	74LS352	1.04
		74LS124	1.39			74LS353	.92
74LS33	.26	74LS125	.36	74LS192	1.04	*74LS362	4.21
74LS37	.23	74LS126	.36	74LS193	1.04	74LS365	.56
74LS21	.20	74LS132	.60	*74LS194	.86	74LS368	.55
74LS40	.20	74LS133	.39	74LS195	.97	74LS367	.55
74LS42	.65	74LS136	.36	74LS196	.97	74LS368	.55
74LS47	.81	74LS138	.65	74LS197	.97	*74LS373	.78
74LS48	.81	74LS139	.65	74LS221	.92	74LS386	.36
74LS49	.81	74LS145	.97	74LS240	2.08	*74LS393	.84
74LS51	.18	74LS151	.81	74LS241	2.08	*74LS668	1.17
74LS54	.18	74LS153	.52	74LS242	2.08	74LS670	1.71
74LS55	.18	74LS154	1.30	74LS243	2.08		

INFRA COMPUTER COMPONENTS LTD.

7 WESTFIELD ROAD,
GREAT SHELFORD
CAMBRIDGE CB2 5JW
TEL: 0223-841728

• Circle No. 290

Karadawn Ltd.

Micro Computer Systems & Software

2 Forrest Way, Gatewath Industrial Estate, Warrington, Cheshire.
Tel: 0925-572668. Telex: 628269

Business Systems

- THE INCREDIBLE ROSTRONICS Z PLUS
- 2 MEGABYTE CAPACITY • Z80 CPU • 64K RAM
 - ELBIT 1920-x TERMINAL WITH 15" SCREEN
 - FULLY HOUSED IN CUSTOM BUILT WORKSTATION
 - DELIVERED + INSTALLED AT ONLY £4500.00

Printers for the above from £925 — £2,500 by Teletype, Diablo, Qume, Centronics, Texas Instruments.
10 Megabyte Hard Disk system £7,950.

THE ULTIMATE PERSONAL/SMALL BUSINESS MICRO

Superbrain by Intertec

- 320K Dual Double Density Floppies • CP/m Op System
- 64K • TWIN Z80 A MICROPROCESSORS

DELIVERED + INSTALLED AT ONLY £1,950.00

N.B. This is NOT a model CPI SUPERBRAIN

Word Processor Systems

- * 2 MEG Z Plus system * Diablo Heavy Duty Daisywheel
- * "Wordstar" Word Processor Pack *

DELIVERED + INSTALLED FROM £6,950.00

For the Personal Computer

- PRINTERS Centronics 730 80/132 Character Mode, Roll/Sheet/Sprocket £425 Paper Feed, 110 C.P.S. 6 INTERNATIONAL CHR Sets. TEAC Disc Drives. Smooth as silk Single Drives £250 Inc Cable. Double Drives £450 Inc. Cable.

Floppies FREE plastic library case with every 10 disks 5 1/4" verbatim £30 inc vat.

8 1/4" Double sided, double density £45 inc VAT

ALL SYSTEMS CAN BE SUPPLIED WITH INDIVIDUALLY WRITTEN SOFTWARE
TAILORED TO YOUR EXACT SPECIFICATIONS BY OUR OWN PROGRAMMERS.
ALL OUR SOFTWARE IS FULLY SUPPORTED.

• Circle No. 291

PETAID EVERY PET SHOULD HAVE ONE!

PURPOSE: Provides the complete basic structure for file and screen creation and subsequent Insert, Amend, Delete, Display, Search and Print.

BENEFITS: Simple commands, no need for programming knowledge. Create your own screen and file layouts. Files up in hours. Highly structured in Basic. Simple appendment of further basic code for maths and specialised prints, well documented to allow the user to modify the program. Standard variables used, can halve the time for systems development. Common structure for ease of subsequent support. A very powerful STAND ALONE file create and retrieval system. The create file program can be used many times for various files. Further compatible utilities to be available.

VERSIONS AVAILABLE: Tape Files £52.95, Sequential Disk £150.65, Random Access Commodore Disk and Computhink 400K £208.15, Computhink 800K £231.15, Indexed Access Method Commodore Disk (Alpha Key Field) £288.65, Extract & Sort on Random Access or IAM Files £87.40.

All prices include V.A.T., Package and Postage.

PRINTERS SUPPORTED: Commodore, Anadex, Gume, Teletype 43.

FEATURES, The user may: Define their own screen and file formats. Multiple disks per file. Very powerful search routine on any field and any content. Up to 50 separate search criteria or multiple simultaneous searches. Unlimited number of fields per record. PETAID programs within same Version are compatible with all PETAID created files of that version. Tape to Disk conversion utility as an extra.

PACKAGES: ALL PACKAGES REQUIRE: 32K PET, COMMODORE DISK & PRINTER

INCOMPLETE RECORD SYSTEM PETAID Based Provides user specified Account Numbers, Titles and Final Account formats. Common input for new or carry forward clients. Up to 2300 Nominal Account Numbers. Unlimited transactions.
Incomplete £750 Final Accounts £350

BANK & RECONCILIATION PETAID Based Bank Accounting System, automatic facility for standing orders and direct debits. Reminder for charges and interest. 2000 Transactions per Bank Account. £100

ESTATE AGENTS PACKAGE PETAID Based Property and Applicants registers for speedy selection of properties or Applicants. 325 Applicants or Properties per disk. £250

MAILING SYSTEM PETAID Based A complete Mailing Suite, labels, lists, multiple labels. Labels selective based on Interest groups, etc. £100

BOND & PENSION CALCULATIONS Allows the Broker or Agent to use the PET as a selling AID to Demonstrate Bond & Pension and Insurance Quotations. £100

QUOTE PROCESSOR PETAID Based Word Processor in Basic with Mathematics for wordy and complex quotation production. 150 Paragraphs of 10 lines each with price field per line. £120

GENERAL ACCOUNTING PACKAGE PETAID Based Open item Sales, Purchase, Nominal, Rechargeable Costs, error and status checking (back up forced). One posting routine for all transactions. 4000 Accounts and 1B400 live transactions. £600

OTHER PROGRAMS STOCK £100, BLOCK COPY (Bad Blocks Omitted) £25, DIARY PLANNER £100, DOUBLE PRECISION MATHS (M/C Code) £50.

SOFTWARE SUPPORT SYSTEM

Stage One Software offers a special support and reporting system to enable the users of our Software to get the very best support and advice on how to gain maximum benefit from our packages. Enquiries

will be actioned promptly to provide a first class service which has so far been lacking in the Micro-computer industry.

Adda Computers
LONDON W5 2NH
Tel: 01 579 5845

Catlands Computers Ltd
CHESHIRE
Tel: 0625 527255

Metclean Ltd
LONDON SW1E 5JL
Tel: 01 828 2511

Sheffield Computer Centre
SHEFFIELD
Tel: 0742 53519

R Ward & Son
GATESHEAD, Tyne & Wear
Tel: 0632 605915

Advanced Management Systems Ltd
LONDON EC2Y 9AA
Tel: 01 838 9318
01 806 4975

D A M's Office Equipment Ltd
LIVERPOOL
Tel: 051 227 3301

Microware Computers Ltd
HULL HU4 6SB
Tel: 0482 5627107

Slough Microshop
SLOUGH
Tel: 0753 72470

Walters Computers Systems Ltd
STOURBRIDGE, W Midlands
Tel: 0562 865937

Alpha Business Systems
HERTFORD
Tel: 0992 57423

G M Marketing
ANDOVER, Hants
Tel: 026 471 410

Milequip Ltd
GLOUCESTERSHIRE
Tel: 059 451 824

Software Development Services Ltd
DUBLIN 4
Tel: Dublin 695755

Microcomputers Ltd
KENDAL, Cumbria
Tel: 096 82 4101

Amplicon Micro Systems Ltd
BRIGHTON
Tel: 0273 562813

J.A.D. Integrated Services Ltd
PLYMOUTH
Tel: 0752 82616

MMS
BEDFORD
Tel: 0234 40802

Tekdata
STOKE ON TRENT ST6 4PA
Tel: 0782 813831

Business Electronics
SOUTHAMPTON
Tel: 0703 738248

Jeffrey Martin Computer Services Ltd
NEWQUAY
Tel: 063 73 2863

R.P.L. Microsystems
DOUGLAS, I.O.M
Tel: 0624 4247

T & V Johnson (Microcomputers)
CAMBERLEY, Surrey
Tel: 0276 62506

Computer Services Midlands Ltd
BIRMINGHAM B23 6DX
Tel: 021 382 4171

Melard Services (Fylde) Ltd
POULTON LE FYLDE, Lancs
Tel: 0253 823654

RUF Computers (UK) Ltd
BURGESS HILL, Sussex
Tel: 04446 45211

Thistle Computers
ORKNEY KW15 1HG
Tel: 0856 3140

MAIL ORDER Written orders with cheque or Access/Visa No. to:

STAGE ONE SOFTWARE 6 Criterion Arcade, Old Christchurch Road, Bournemouth. 23570



Please supply: ITEM QUANTITY

AMOUNT £ CHEQUE NO.

Name

Address ACCESS/VISA NO.

CAN WE HELP YOU

PET — 48/80 COLUMN —
COMMUNICATION
DEALERS

SUPERBRAIN 32/64K
SD/QD

APPLE SYSTEMS

PRINTERS

NEC, QUME; OLIVETTI, DAISYWHEELS

+ VARIOUS DOT MATRIX, FORM/TRACTOR
FEED

SOFTWARE

INCOMPLETE RECORDS, SALES — PURCHASE +
NOMINAL LEDGER, STOCK CONTROL, VAT
PAYROLL, WORD-PROCESSING, —
NUMEROUS OTHER PACKAGES AVAILABLE.

COMPUTER SALES & SOFTWARE CENTRE LTD

190-192 CRANBROOK RD, ILFORD; ESSEX

01-554-3344

• Circle No. 293

NEWDOS80 — APPARAT'S DOS FOR THE 80's

- * Up to 4095 bytes per record on disc files
- * Variable — length records
- * 5 or 8 inch disc drives of 35, 40, 80 tracks may be mixed
- * DOS and BASIC command chaning
- * Print Spooler provided for concurrent printing and other processing
- * NEWDOS and TRSDOS compatible
- * PLUS MUCH MORE !!!

£65 including detailed manual
BUSINESS SOFTWARE

Contact us to discuss your application

UDMS INFORMATION MANAGEMENT FOR THE NON-PROGRAMMER

- * Powerful, easy-to-use facilities for data storage, update, and reporting
- * Ideal for business applications
- * Extremely flexibile
- * Save £££'s on software costs!
- * Versions for TRS80 I and II
- * Comprehensive users manual

Basic Version £75 Full Version £150 Manual

only £6.00

MICROLINE-80 PRINTER

Phone for lowest price

Prices exclude V.A.T. and Postage.

CLEARTONE COMPUTER CONSULTANTS LTD.
PRINCE OF WALES INDUSTRIAL ESTATE
ABERCARN, GWENT NP1 5RJ Tel: (0495) 244555

CLEARTONE

• Circle No. 294

ELECTRONIC GAMES

ATARI

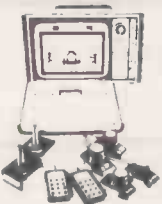

SPECIAL PRICE
£86 + VAT

INTELLIVISION MATTEL



£173.87 + VAT

Available August 1980
This is the most advanced TV
game in the world.
Expandable
next year into a full
microcomputer.
COLOUR CATALOGUE
AVAILABLE WITH
DETAILS ON ALL THE
CARTRIDGES

CHESS



Send for further details.

COMPUTERS

NEW RANGE
AVAILABLE
AUGUST 1980
We specialise in
computer chess
machines & stock
over 13 different
models from
£20 to £300

TELETEXT



RADOFIN
TELETEXT
Add on Adaptor

£199 + VAT

BRIDGE

COMPUTER



- * Plays 1/2/3 or 4 Hands
- * Problem Mode
- * Audio Feedback
- * Instant Response
- * Auto scorekeeping

BACKGAMMON



From £38 to £108. Send for further details.

COMPUTERS

OMAR 1
OMAR 2
CHALLENGER
GAMMONMASTER

SPACE INVADERS



HAND HELDS - CARTRIDGES
ATARI ACETRONIC
PRINZTRONIC
RADOFIN DATABASE etc.

We keep a full range!
Send for cartridge lists stating which
machine you own

DRAUGHTS

COMPUTER



- * Solves Problems
- * Rejects illegal moves
- * 2 level machine
£43 + VAT
- * 4 level machine
£77.78 + VAT

LEISURE

- * CHEAP TV GAMES
- * TELEPHONE ANSWERING MACHINES
- * AUTO DIALERS
- * CALCULATORS
- * DIGITAL WATCHES
- * PRESTEL
- * HAND HELD GAMES

27 TUNE DOOR BELL £17.13

+ VAT

FREE CATALOGUE

For a free copy
of our 32 page
catalogue, send
a 12p stamp to
Silica Shop Ltd
or Telephone
01-301 1111

MAIL ORDER SERVICE — Free postage & Packing

TELEPHONE & MAIL ORDERS - accepted on
Access * Barclaycard * American Express * Diners Club

CALLERS WELCOME — at our shop in Welling — Demonstrations daily
Open from 9am-5pm Mon-Sat (9am-1pm Wed)

GUARANTEE — Full 12 months + After Sales Support

We have comprehensive brochures on all products. Please let us know what you are interested in and we will send you detailed brochures AND our own
32 page catalogue covering most games on the market.

SILICA SHOP

SILICA SHOP LTD., Dept. PC9
102 Bellegrave Road
Welling, Kent DA16 30F
Tel: 01-301 1111

• Circle No. 295

PRACTICAL COMPUTING January 1981

TTLs by TEXAS		74LS161		75p		4002		20p		4560		200p		PERIPHERALS		MEMORIES		INTERFACE ICs		MISCELLANEOUS	
7400	11p	74174	90p	74LS162	140p	4006	95p	4569	250p	3242	800p	2101-4L	400p	ADS36A	1300p	AD558	775p	AD7524	600p	6MHz UHF Mod.	350p
7401	12p	74175	85p	74LS163	100p	4007	20p	4572	400p	3245	450p	2102-2L	120p	AD5611	1400p	AD7524	600p	DAIC1408-B	200p	8MHz UHF Mod.	450p
7402	12p	74176	90p	74LS164	90p	4008	80p	4583	110p	6522	650p	2111-4L	300p	DM1823	175p	DM18131	375p	DP304	450p	16 Key Pad	450p
7403	14p	74177	90p	74LS165	140p	4009	40p	4584	90p	6532	800p	2114-2L	340p	DM18131	375p	DP304	450p	DS8833	250p	5100 Busboard	1500p
7404	14p	74178	160p	74LS166	180p	4010	50p	4585	150p	6820	375p	2114-3L	350p	DS8833	250p	DS8836	150p	MC1488	75p	DIN41612 Plug	450p
7405	18p	74180	93p	74LS173	110p	4011	20p	4724	250p	6821	340p	2114-4L	250p	DS8836	150p	MC1489	75p	MM58174	1200p	DIN41612 Socket	450p
7406	36p	74181	160p	74LS174	100p	4012	25p	40097	90p	6850	300p	2114-3L	350p	DS8836	150p	MM58174	1200p	4016-4	P.O.A.	43 way Edge Con	250p
7407	36p	74182	90p	74LS175	100p	4013	50p	14411	1100p	6852	370p	2114-4L	250p	DS8836	150p	MM58174	1200p	4044-4	600p	31 way Plug 0.1"	120p
7408	17p	74184A	150p	74LS181	320p	4014	84p	14412	1100p	8155	1100p	4027-3	350p	DS8836	150p	MM58174	1200p	4116-2	300p	31 way SKI 0.1"	120p
7409	19p	74185	150p	74LS190	100p	4015	84p	14433	1100p	8205	320p	4044-4	600p	DS8836	150p	MM58174	1200p	4118-4	1200p	Logic Probe LP1	120p
7410	15p	74188	325p	74LS191	100p	4016	45p	14500	700p	8212	200p	4116-2	300p	DS8836	150p	MM58174	1200p	5101	400p	Logic Probe LP2	£31
7411	24p	74190	120p	74LS192	100p	4017	70p	14599	290p	8216	200p	4118-4	1200p	DS8836	150p	MM58174	1200p	8224	275p	Logic Probe LP3	£18
7412	20p	74191	120p	74LS193	100p	4018	85p			8226	400p	4016-4	P.O.A.	DS8836	150p	MM58174	1200p	8226	275p	Zero Insertion	£49
7413	30p	74192	100p	74LS194	100p	4019	110p			8228	525p	4016-4	P.O.A.	DS8836	150p	MM58174	1200p	8228	525p	Force Socket	£7
7414	40p	74193	100p	74LS195	140p	4020	100p			8251	475p	4016-4	P.O.A.	DS8836	150p	MM58174	1200p	8251	475p	24 pin	£7
7415	40p	74194	120p	74LS196	120p	4021	110p			8253	1000p	4016-4	P.O.A.	DS8836	150p	MM58174	1200p	8253	1000p	DIL Switches	90p
7416	27p	74195	95p	74LS197	90p	4022	100p			2650A	1600p	4532-2	P.O.A.	DS8836	150p	MM58174	1200p	2650A	1600p	4 way SPST	105p
7417	27p	74196	95p	74LS221	120p	4023	27p			6502	650p	4532-2	P.O.A.	DS8836	150p	MM58174	1200p	6502	650p	8 way SPST	120p
7420	17p	74197	80p	74LS240	175p	4024	50p			6502A	950p	4532-2	P.O.A.	DS8836	150p	MM58174	1200p	6502A	950p	Logic Probe LP1	£31
7421	40p	74198	150p	74LS241	175p	4025	20p			6800	650p	4532-2	P.O.A.	DS8836	150p	MM58174	1200p	6800	650p	Logic Probe LP2	£18
7422	22p	74199	150p	74LS242	170p	4026	130p			6802	950p	4532-2	P.O.A.	DS8836	150p	MM58174	1200p	6802	950p	Logic Probe LP3	£49
7423	34p	74221	160p	74LS243	170p	4027	50p			6809	2000p	4532-2	P.O.A.	DS8836	150p	MM58174	1200p	6809	2000p	Zero Insertion	£7
7425	30p	74251	140p	74LS244	150p	4028	84p			INS8060	1000p	4532-2	P.O.A.	DS8836	150p	MM58174	1200p	INS8060	1000p	Force Socket	£7
7426	40p	74259	250p	74LS245	250p	4029	100p			8080A	450p	4532-2	P.O.A.	DS8836	150p	MM58174	1200p	8080A	450p	24 pin	£7
7427	34p	74278	290p	74LS247	140p	4030	55p			8085A	1100p	4532-2	P.O.A.	DS8836	150p	MM58174	1200p	8085A	1100p	DIL Switches	90p
7428	36p	74279	110p	74LS251	140p	4031	200p			9980	2000p	4532-2	P.O.A.	DS8836	150p	MM58174	1200p	9980	2000p	6 way SPST	105p
7430	17p	74283	90p	74LS253	90p	4034	200p			Z80	850p	4532-2	P.O.A.	DS8836	150p	MM58174	1200p	Z80	850p	8 way SPST	120p
7432	30p	74284	360p	74LS257	90p	4035	110p			Z80A	850p	4532-2	P.O.A.	DS8836	150p	MM58174	1200p	Z80A	850p		
7433	40p	74285	360p	74LS258	160p	4036	295p					4532-2	P.O.A.	DS8836	150p	MM58174	1200p				
7434	35p	74290	150p	74LS259	160p	4039	295p					4532-2	P.O.A.	DS8836	150p	MM58174	1200p				
7438	35p	74293	150p	74LS266	100p	4040	100p					4532-2	P.O.A.	DS8836	150p	MM58174	1200p				
7440	17p	74298	200p	74LS273	170p	4041	80p					4532-2	P.O.A.	DS8836	150p	MM58174	1200p				
7441	70p	74365	100p	74LS279	90p	4042	80p					4532-2	P.O.A.	DS8836	150p	MM58174	1200p				
7442A	60p	74366	100p	74LS283	90p	4043	90p					4532-2	P.O.A.	DS8836	150p	MM58174	1200p				
7443	112p	75467	100p	74LS298	160p	4044	90p					4532-2	P.O.A.	DS8836	150p	MM58174	1200p				
7444	112p	74368	100p	74LS299	375p	4046	110p					4532-2	P.O.A.	DS8836	150p	MM58174	1200p				
7445	100p	74390	200p	74LS323	400p	4047	100p					4532-2	P.O.A.	DS8836	150p	MM58174	1200p				
7446A	93p	74392	200p	74LS324	200p	4048	55p					4532-2	P.O.A.	DS8836	150p	MM58174	1200p				
7447A	75p	74490	225p	74LS324	200p	4049	45p					4532-2	P.O.A.	DS8836	150p	MM58174	1200p				
7448	80p	74490	225p	74LS348	200p	4049	45p					4532-2	P.O.A.	DS8836	150p	MM58174	1200p				
7450	17p	74LS00	14p	74LS365	48p	4050	45p					4532-2	P.O.A.	DS8836	150p	MM58174	1200p				
7451	17p	74LS01	16p	74LS367	70p	4051	80p					4532-2	P.O.A.	DS8836	150p	MM58174	1200p				
7453	17p	74LS02	18p	74LS368	100p	4052	80p					4532-2	P.O.A.	DS8836	150p	MM58174	1200p				
7454	17p	74LS04	16p	74LS373	150p	4053	80p					4532-2	P.O.A.	DS8836	150p	MM58174	1200p				
7460	17p	74LS05	25p	74LS374	150p	4054	150p					4532-2	P.O.A.	DS8836	150p	MM58174	1200p				
7470	36p	74LS08	22p	74LS375	120p	4055	125p					4532-2	P.O.A.	DS8836	150p	MM58174	1200p				
7472	30p	74LS09	21p	74LS377	160p	4056	135p					4532-2	P.O.A.	DS8836	150p	MM58174	1200p				
7473	34p	74LS10	20p	74LS378	140p	4059	600p					4532-2	P.O.A.	DS8836	150p	MM58174	1200p				
7474	30p	74LS12	20p	74LS390	120p	4060	115p					4532-2	P.O.A.	DS8836	150p	MM58174	1200p				
7475	38p	74LS11	40p	74LS393	120p	4063	120p					4532-2	P.O.A.	DS8836	150p	MM58174	1200p				
7476	32p	74LS13	40p	74LS399	200p	4066	50p					4532-2	P.O.A.	DS8836	150p	MM58174	1200p				
7480	50p	74LS14	50p	74LS445	140p	4067	450p					4532-2	P.O.A.	DS8836	150p	MM58174	1200p				
7481	100p	74LS14	50p	74LS640	450p	4068	27p					4532-2	P.O.A.	DS8836	150p	MM58174	1200p				
7482	84p	74LS21	20p	74LS641	450p	4069	20p					4532-2	P.O.A.	DS8836	150p	MM58174	1200p				
7483a	90p	74LS22	27p	74LS642	450p	4070	30p					4532-2	P.O.A.	DS8836	150p	MM58174	1200p				
7484	100p	74LS26	30p	74LS643	450p	4071	25p					4532-2	P.O.A.	DS8836	150p	MM58174	1200p				
7485	110p	74LS27	38p	74LS644	450p	4072	25p					4532-2	P.O.A.	DS8836	150p	MM58174	1200p				
7486	34p	74LS30	25p	74LS668	100p	4073	25p					4532-2	P.O.A.	DS8836	150p	MM58174	1200p				
7489	210p	74LS37	27p	74LS670	250p	4073	25p					4532-2	P.O.A.	DS8836	150p	MM58174	1200p				
7490A	30p	74LS32	27p	74S SERIES		4075	25p					4532-2	P.O.A.	DS8836	150p	MM58174	1200p				
7491	80p	74LS37	30p	74500	60p	4076	107p					4532-2	P.O.A.	DS8836	150p	MM58174	1200p				
7492A	46p	74LS38	38p	74501	60p	4081	27p					4532-2	P.O.A.	DS8836	150p	MM58174	1200p				
7493A	36p	74LS40	25p	74505	75p	4082	27p					4532-2	P.O.A.	DS8836	150p	MM58174	1200p				
7494	84p	74LS42	70p	74508	75p	4086	72p					4532-2	P.O.A.	DS8836	150p	MM58174	1200p				
7495A	70p	74LS47	75p	74510	60p	4089	150p					4532-2	P.O.A.	DS8836	150p	MM58174	1200p				
7496	65p	74LS51	24p	74512	60p	4093	70p					4									

*** BOOKS * BOOKS * BOOKS * BOOKS * BOOKS ***

NEW TOWERS INTERNATIONAL MICROPROCESSOR SELECTOR £16.25
 Over 7,000 American, British European and Japanese microprocessors, memories, interfaces, and related lsi circuits with electrical and mechanical specifications, supported by information on sources and substitutes.

T.M. Adam MASTER GUIDE TO ELECTRONIC CIRCUITS £9.25
 Whatever interest you have in Electronics this massive 616 page sourcebook of information should answer the questions you could possibly have about electronic circuits and components and how they work.

C.L. Hallmark MASTER I.C. COOKBOOK £7.45
 Use it now information on most IC family and function CMOS & TTL 4000 - 7400 series. Digital IC's exotic CMOS and linear IC's.

R.L. Goodman TROUBLESHOOTING MICRO-PROCESSORS AND DIGITAL LOGIC £5.90
 Complete guide to troubleshooting and servicing.

M. Hordeski ILLUSTRATED DICTIONARY OF MICROCOMPUTER TERMINOLOGY £6.95
 Clear concise encyclopedia of definitions of nearly 4,000 computer terms words and jargon.

E.L. Stafford COMPLETE MICROCOMPUTER SYSTEMS HANDBOOK £8.75
 Complete guide to microcomputers — how they operate, how to use them, program them, and how to troubleshoot and repair.

M. Sawusch 1001 THINGS TO DO WITH YOUR PERSONAL COMPUTER £6.00
 If you own a home computer or are involved professionally you'll find this unique new volume a goldmine of terrific applications.

K. Tracton 57 PRACTICAL PROGRAMS AND GAMES IN BASIC £6.40
 Programs for everything from space war games to blackjack from craps to I Ching.

Adams. C. BEGINNERS GUIDE TO COMPUTERS AND MICROPROCESSORS WITH PROJECTS £6.05
 Down to earth introduction to understanding building programming and operating your own microcomputer.

Towers. T.D. INTERNATIONAL TRANSISTOR SELECTOR UPDATE 2 ££10.70
 Over 20,000 American, British, European and Japanese transistors with electrical and Mechanical Specifications manufacturers and available substitutes.

Prices include postage and packing. Available from: —
**Technical Book Services, PC2,
 P.O. Box 79, Maidenhead, Berks SL6 2EG**

• Circle No. 296

**don't buy a
 daisy wheel
 printer....
 before
 phoning
 328 7145**

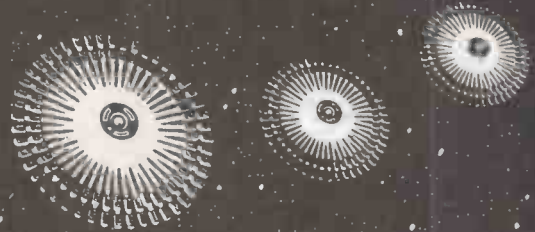

full range of PET interfaces
small systems engineering limited
 2-4 Canfield Place · London · NW6 3BT · Tel 01-328 7145/6

• Circle No. 297

MULTI USER MICRO SYSTEM!

NO IT'S NOT A JOKE, IT'S A REALITY! IT'S CALLED MVT-FAMOS, AND IT'S UP AND RUNNING ON OUR IMS 8000 RANGE AT THIS VERY MOMENT

That's right, it's not 'Coming Shortly', it's not 'Available in the near future', and it's certainly not 'Soon to be released'. It's available now, and we can demonstrate it at your convenience.

MVT-FAMOS is a full multi-user, multi-tasking Z 80 based operating system, which means that you can have several terminals running many different types of systems, such as stock control, accounting and payroll, all at the same time. Or you may wish to have several people all accessing the same system, MVT-FAMOS doesn't mind, it's entirely up to you.

You don't have to spend a lot of money to get started with FAMOS either, a 2 drive floppy based system with 64K of RAM storage, VDU and printer sells for as little as £5,500 (Five Thousand Five Hundred). But once you start there's no stopping, because you can increase the number of terminals, the amount of RAM memory, and even add multiple hard disk drives, giving you millions of bytes of data storage.

So if you would like to arrange for a demonstration of this extremely advanced and versatile system, or even just to get some more information, contact: —

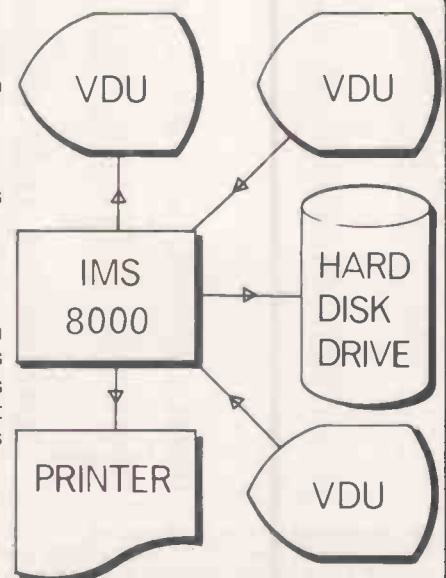

MICROTEK COMPUTER SERVICES

50 Chislehurst Road, Orpington, Kent, BR5 0DJ. Tel: Orpington 26803

• Circle No. 298

NEW THE TUSCAN S100

A Z80 based S100 Computer System.

TUSCAN main board. The heart of the system with Z80, video, Ram, Rom, and I/O plus five S100 slots for expansion.

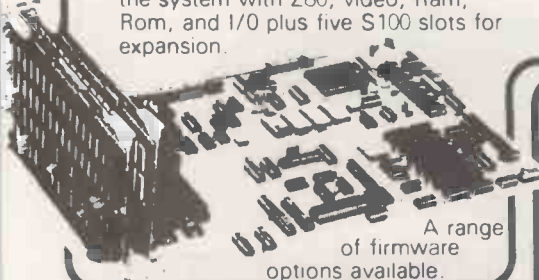

A range of firmware options available.

Available in Kit Form or Assembled. All components available separately.

Houses two 5 1/4" drives for a compact business system

Professional case will house the complete system

Two keyboard options

Hinged lid for easy access

Stylish finish ideal for office or home.



On Demonstration NOW

KITS from

£195 + VAT delivery Ex-Stock

NASCOM-2

MICRO-KIT COMPUTER WITH IMPROVED 16K B RAM Board



Ex-stock only £335 + VAT

Full after sales service

Firmware & MOS ICs Software
 Zeap Assembler (4, 1Kx8 EPROMS) £50
 Nas Pen text editor (2, 1Kx8 EPROMS) £30
Expansion boards (in kit form)
 48K RAM £210 • 32K RAM £175.00
 16K RAM £140
EPROM CARD (NASCOM compatible) KIT. Suitable for 16 x 2708 or 16 x 2716 or mixed 1 x NASCOM 8k BASIC ROM £66.00. BASIC programmers aid. Self locating tape £14.95.

POWER SUPPLY £29.50

NASCOM PRODUCT LIST + VAT

I/O board kit less I/O chips	45.00
UART + BAUD rate generator + crystal for I/O board	16.00
Econographics kit for additional 128 characters (N1 only)	30.00
2708/2716 Programmer suitable for N1 and N2 under NAS-SYS	£20.95
Nascom 19" rack mounting card frame for N1 and N2	32.50
Nas-DA disassembler 3 EPROM for Nas-sys	37.50
MK36271 8K BASIC in 8K x 8 ROM	30.00
Naspen VS in 2 EPROM	25.00
Nas-sys monitor in 2 EPROM	£8.50
4 Games Tape	25.00
Nasbug T4 2 x EPROM	25.00
Tiny Basic 2 x EPROM	37.50
Super Tiny Basic 3 x EPROM	25.00
Super Tiny Basic upgrade 1 x EPROM	12.50
Tape Software	
ZEAP 2 tape and documentation for Nas-sys	30.00
8K BASIC tape and documentation for N1	15.00

THE HENELEC DISK SYSTEM

FOR NASCOM and any other Z80 8080 Microcomputer with an uncommitted P10

DISKS

- The Henelec controller card plugs direct into a Z80 P10 and controls up to 3 double-sided mini-floppy drives giving a maximum 480K system.
 - General Purpose FDC control software for simple DOS or for CPM.
 - Simple DDS software for NASCOM 1/2 under NAS-SYS
 - OR ROM CB10S for CPM on NASCOM 1/2 incorporating the major NAS SYS features Maximum 60K CPM system
 - New MD prom supplied for N2/CPM
- TWO SYSTEMS**
- SIM-DOS "Floppy Tape Recorder" with 1 drive PSU firmware, etc. Double sided £360 plus VAT
 - CPM System with 1 drive, double sided PSU firmware, etc. £450 plus VAT
 - Additional Drives with PSU £205 plus VAT



TANGERINE

COMPUTER SYSTEMS

"MICRON"

the latest line in superb products on demonstration from your London stockist

EX-STOCK

£395.00 inc. VAT BRITISH DESIGN

- 6502 based microcomputer
- VDU alpha numeric display
- Powerful monitor TANBUG
- 8K RAM
- 32 parallel I/O lines
- 2 serial I/O lines
- RS 232 C/20mA loop, with 16 programmable Baud rates
- Four 16 Bit counter timers
- CUTS cassette recorder interface
- Data bus buffering
- Memory mapping control
- 71 Key ASCII Keyboard, including numeric keypad and with auto repeat
- Including metal cabinets for both keyboard and modules
- Including power supply
- 10K Microsoft BASIC

NASCOM-1

12" x 8" PCB carrying 5LSI MOS packages, 16 1K MOS memory packages and 33 TTL packages. There is on-board interface for UHF or unmodulated video and cassette or teletype. The 4K memory block is assigned to the operating system and video display leaving a 1K user RAM. The MPU is the standard Z80 which is capable of executing 158 instructions including all 8080 code.

Nascom-1 Kit Price **£125** Plus VAT + P&P £1.50

325



PLAIN PAPER £325 PRINTER

Fully built and housed in a stylish enclosure for just £325 plus VAT.

INTERFACES WITH ALL MICRO COMPUTERS

The Nascom IMP (Impact Matrix Printer) features are

- 60 lines per minute. • 80 characters per line.
 - Bi-directional printing. • 10 line print buffer.
 - Automatic CR/LF. • 96 character ASCII set (including upper/lower case, \$, £).
 - Accepts 8 1/2" paper (pressure feed). • Accepts 9 1/2" paper (tractor feed).
 - Tractor/pressure feed. Baud rate from 110 to 9600. • External signal for optional synchronisation of baud rate.
- IDEAL FOR WORD PROCESSING**

COMPUTER KEYBOARDS

APPLE COMPUTER KEYBOARD

52 Key 7 Bit ASCII coded Positive Strobe +5V - 12V Size 13x4 1/4" Sturdy Construction Sloping Keys Black/White print. Made in USA for Apple Inc. Brand New £36 incl VAT. Post £2.50 Individually packed in ANTI-STATIC FOAM.

71 KEY ASCII KEYBOARD INCLUDING NUMERIC KEYPAD. £49.00 plus £7.35 VAT TOTAL £56.35. Uses gold crosspoint keys. Includes keypad and ribbon cable. Only available as fully assembled and tested



CARTER 57 key ASCII keyboard. Conventional key board. 128 ASCII characters including control keys. Parallel output with strobe. Shift lock. + 5 V and -12 V DC. 12" x 5.5" x 1.5" Black keys with white legends.

39.34 + VAT.

FERRANTI - "SIZE 14 x 6 x 3" SLOPING FRONT" 55 Key ASCII Coded in steel case. Complete with Plug and Cable with circuit to convert to T.T.L. levels.

In good condition at only £19.95 + VAT, P/P £2.50

CENTRONICS QUICK PRINTER



List Price £459 incl. VAT

OUR PRICE plus VAT

EXCLUSIVE TO HENRY'S 50% OFF MAKER'S PRICE

£195

for:

TANDY, PET, NASCOM Centronics parallel data interface for Nascom, Tandy, etc. 240 volt mains input. ASCII character set Paper feed, and on/off select switches 'BELL' signal! Weight 10lbs Size: 13" x 10 1/2" x 4 1/2"

MONITORS

New and Reconditioned FROM £36

Microtan 65 kit	£69.00	Tanex assembled	53.00
Microtan 65 assembled	79.00	Tanex (expanded) kit	106.50
Lower case option	9.48	Tanex (expanded) classmbld	116.50
Graphics option	6.52	Serial I/O option	12.87
20 way keypad	10.00	Tanram kit	34.00
Full ASCII keyboard	49.00	Tanram assembled	44.00
Tanex kit	43.00	Tanram (expanded) classmbld	190.00

TANGERINE

LONDON STOCKISTS

MPS1 power supply	23.00
Mini Mother board	10.00
Mini Rack	43.00

10K extended Microsoft in ROM £39.00

10K extended Microsoft in EPROM 49.00

SEND FOR COMPLETE COMPUTER BROCHURE FREEPOST TO ADDRESS BELOW

MEMORIES Discounts 10% for 4, 15% for 8, 20% for 16		
MK 3880 (N280)	7.50	
MK 3880 N4 (Z80A)	7.95	2708
MK 4116 16K x 1 dy RAM	6.50	2716
MK 4027 4K x 1 dy RAM	2.25	IM6402 UART
2102 1K x 1 static RAM	1.00	2114 1K x 4 static RAM
4118 1K x 8 static RAM	12.75	8080A

ADD VAT 15% TO YOUR ORDER EXCEPT WHERE STATED



HENRY'S

Computer Kit Division
 404 Edgware Road, London, W2, England I.E.D.
 01-402 6822

Official Export & Educational Orders Welcome
 Our telex: 282284
 Mono Ref. 1400 Transonics

ICE INDEPENDENT COMPUTER ENGINEERING LIMITED

CROMEMCO Systems & Software

SYSTEM ZERO — the latest low-cost Computer from Cromemco.

S CP-M 2.2 four Cromemco Systems
£95 + VAT.

64K S100 Memory Boards £350 + VAT.

10 Megabyte Cartridge Disk
(5 Megabyte fixed, 5 removable)
for the S100 Bus

£3,950 including installation
(London area)
+ VAT

We supply computer solutions to business problems

- Software packages
- Hardware maintenance
- Hardware configuration and design

We also have an "Aladdin's Cave" of computer spares, power supplies, boards, chips, etc, etc.

For further details and information please contact:

Independent Computer Engineering Limited,
16/18 Littleton Road, Ashford, Middlesex.

Tel: Ashford (07842) 47171/47172

Telex: 8952042 (DPCUST G)



EPSON — MX80 DOT MATRIX PRINTER

The Printer you have been waiting for

- 9 x 9 matrix (true descenders in lower case)
- 80 cps bidirectional printing with logical seeking print head (maximises throughput)
- 96 ASCII character set, plus 64 graphics incorporating 4 switch selectable European language options
- Programmable forms handling
- 12 different print modes, up to 132 characters per line
- Operator controls and indicators, including self test feature
- **£395** (+ VAT) with standard parallel interface (options: RS232, Apple, Pet, TRS80, MZ80)

• Circle No. 300

Letter^S from America

A is for Apple II and III — we sell them both **from £695**

B is for Bismark — the game that puts your Apple in the North Atlantic with you in command **only £45**

C is for columns — 80 in all — the new Videoterm card turns your Apple into a true computer screen **only £225**

D is for Disk Drives — bigger and better storage for your Apple — from 256K to 10Mb. **from £900**

E is for Eighty Eight T — the low cost full function printer which not only works — it's quiet and looks good **only £395**

F is for Flight Simulator — take off for the wide blue yonder with your Apple as the plane! **only £15**

G is for Graphics — superb and in 3D **only £75**

H is for Hawaii — where we'll be on holiday if only you'd buy some!

The Computer Shop

Computers for Science, Business and Education.

54 High Street, Banbury, Oxon. Telephone: Banbury (0295) 3477

40 Prospect Street, Caversham, Reading, Berks. Telephone: Reading (0734) 481555

25 Havelock Street, Swindon, Wilts. Telephone: Swindon (0793) 694061

• Circle No. 301

PRACTICAL COMPUTING January 1981

• Circle No. 302 ▶

HAL COMPUTERS

NEW FROM



A complete range of professional floppy disc products from the industry leaders....compatible with TRS 80, Superbrain, Ohio, SWTP, North Star Horizon, Zenith, Cromemco etc.

You can now buy the entire range of Tandon Magnetics high quality, market leading, mini flexible disc drives direct from the exclusive U.K. Distributor.

Tandon drives are available as either the OEM product or as complete packaged units in single or dual drive British manufactured cabinets with high reliability power supply. Complete pre-test and burn in ensures reliability and all drives carry a full 6 months parts and labour warranty.



BOXED DRIVE PRICES

	Single Box	Dual Box
Single Sided 40 track	£250.00	£430.00
Double Sided 40 track	£330.00	£599.00
Double Sided 80 track	£430.00	£808.00
Dual Boxed Single Sided plus double sided	£549.00	

With Tandon you get 40 or 80 tracks—more capacity and step rates as low as 3 mS track to track—up to ten times the speed of other drives.



MICROTEK PRINTERS



So reliable we give you 365 days warranty.
40, 80, 120, 132 columns.
125 cps. 70 lines/minute.
96 characters, upper/lower case.
Prices start at: £460.00
Interface cables for Apple, TRS-80 etc.



STROBE PLOTTERS



The Strobe drum plotter uses low cost colour pens to draw graphs, charts and pictures with .004" resolution.

Prices start at £545.00

Interfaces and software for TRS-80, Apple, PET, Horizon, S-100 on 5" and 8" diskettes.

STORAGE SYSTEMS



Use our discoflex range of storage wallets and boxes to protect your discs when not in use, or for sending through the post.

5 1/4"	£10.00
8"	£12.00

POWER SUPPLIES



Our range of Power-One power supplies covers single, dual and triple output not to mention a complete selection of supplies which power all popular floppy disc drives.



SERVICE AND MAINTENANCE



For the large scale user of 5 1/4" or 8" floppy disc drives, our range of alignment diskettes and service tools are a must. Send for details of our Oasis range of portable dedicated and non-dedicated floppy disc and peripheral test and exerciser systems.

For immediate information on any of these products please contact:

HAL COMPUTERS LIMITED

133 Woodham Lane New Haw
Weybridge Surrey KT15 3NJ
Tel: Weybridge (0932) 48346/7
Telex: 8813487

VERBATIM MAGNETIC MEDIA



THE BEST THAT MONEY CAN BUY.

VERBATIM — the world's finest and best known range of magnetic data storage products — includes Floppy Discs, Mini-Floppies, Cassettes, Mini-Cassettes, cartridges and cards. All are 100% tested during manufacture, all are *certified* error free. We stock all types, including all varieties of the popular 5 1/4-inch floppy discs.

If you are a dealer:

Start stocking VERBATIM products — your customers will appreciate a better quality product at better prices. Call BFI Electronics for a comprehensive catalogue, dealer price list, and details of display material and retail packaging.

If you are a user:

Your system is only as good as its data storage — so don't be content with inferior products. Insist on VERBATIM by name, as indeed do some of the biggest names in the computer business!

BFI Electronics Limited
516 Walton Road,
West Molesey,
Surrey KT8 0QF
Tel: 01-941 4066
Telex: 261395

• Circle No. 303

IF ITS
FOR



CONTACT PDS

NORTHERN DISTRIBUTOR FOR SOLITAIRE WP SYSTEMS

DEALER ENQUIRIES WELCOME—

SOFTWARE		HARDWARE	
WORD P From	£42.00	APPLE II 16K	£695.00
DATA BASE SYSTEMS From	£99.00	16K Addon	£69.00
PAYROLLES	£375.00	Disk Drive with controller	£349.00
LEDGERS		Disk Drive	£299.00
FULLY INTEGRATED	£855.00	VIDEO	
SALES	£315.00	12" Black/white	£189.00
PURCHASE	£315.00	9" Black/white	£127.00
NOMINAL	£225.00	Video-cable	£9.00
INVOICING	£140.00	12" Green/black	£164.00
VISCAL	£95.00	PRINTERS	
DESK TOP PLAN	£64.00	PAPER TIGER WITH GRAPHICS	
MAILING LIST	£27.00		£598.00
BOWLING DISK	£9.00	SILENTYPE	£349.00
CONT VOLS 1-2	£27.00	QUEMES	P.O.A.
CONT VOLS 3-5	£60.00	IBM SELECTRICS	P.O.A.
GAMES DISKS FROM	£10.00	ANADIX 9500	£895.00
		CARDS	
		INTEGER CARD	£116.00
		PASCAL LANG	£299.00
		PARALLEL CARD	£104.00
		SERIAL	£113.00
		ROMPLUS CARD	£116.00
		BLACK WHITE MOD	£14.00

All prices quoted are PLUS VAT

Can't see what you want? ...
Give us a call; we can still supply it.

CALL DAVE ELLIOTT —

PROFESSIONAL DATA SYSTEMS

CARNE HOUSE, MARKLAND HILL
CHORLEY NEW ROAD, BOLTON, LANCs.
Tele: Bolton (0204) 493816

• Circle No. 304

**P C
S L**

Purley Computer Systems Ltd
21 Bartholemew Street
Newbury, Berks (0635-41784)

We are specialist suppliers of TOTAL micro based systems for small business users, all CP/M based.

TRITON & TUSCAN systems P.O.A.

- Word processing system
- Estate agents suites
- Insurance agents suites

Shugart SA800 £375. SA850 £550. Pertec FD 650 8" double sided double density drive £500.

PROM Burning/erasing service: —

(1) Erasing £1.00 (2) Burning from your Hex code £10.00 plus cost of prom (3) copy your master £3.00 plus cost of prom.

DON'T get lost in the jungle —

We specialise in individual needs, and provide back up support.

We have 25 years experience with big machines behind us.

ALL prices exclude VAT (15%) p&p
Securicor delivery £12.50 extra

STOP PRESS!!

5 ONLY reconditioned ICL KSR
Termprinters — £300.00 each.

• Circle No. 305

SIRTON COMPUTERS



76 Godstone Road, Kenley (Nr Croydon) Surrey CR2 5AA
Tel: 01-668 0761/2

NOW WITH MP/M

MIDAS S.100 SYSTEMS

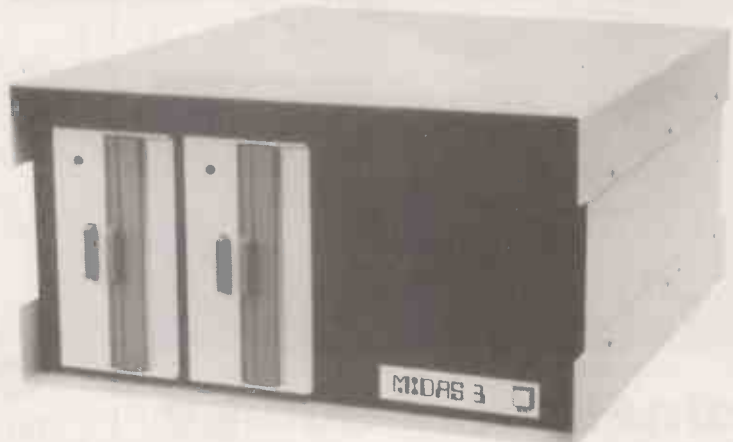

MIDAS 1: From £750
MIDAS 2: From £1580
MIDAS 3: From £2150
MIDAS 4: From £5900
ITHACA-DPS 1: From £1075

- Our versatile Z80 Microcomputers are available as standard units or custom configured to your exact specification from a comprehensive range of stocked S100 boards.
- Disc storage capacity of the MIDAS 3 can be 2M Bytes, expandable to over 20M Bytes with a Winchester Hard Disc Unit in our MIDAS 4 range.
- MIDAS runs CP/M and MP/M is also available. Other Software includes M-BASIC, C-BASIC, FORTRAN, COBOL, CIS-COBOL, PASCAL and Word Processing.
- **A MIDAS 3, with 64K RAM and 2M Bytes storage on two 8" drives with two Serial I/O Ports and CP/M 2 only £2835.**
- Multi-User System (four users) — MIDAS 3 with four 48K blocks of RAM, 1 MByte disc storage on two 8" drives and four Serial I/O Ports, and CP/M 2 + MP/M — **£3850.**
- Printers, VDUs and other peripherals stocked to give complete package systems at keen prices.
- Business Packages include Accounts, Stock Control, Purchase Ledger etc etc.

Boards stocked from Ithaca, Godbout, SSM, S D Systems, Vector, Micromation, Mullen, Mountain Hardware, Hi-Tech, Video Vector, Pickles & Trout, Central Data, Cromemco, Thinker Toys — Send for full Price List (many available in kit form).

Processor

Z80 Starter Kit **£188**
SBC100 **£208**
8085/88 CPU **£237**
Z80 CPU 4 MHz from **£130**

EPROM

2708 EPROM (16K) **£60**
2708/2716 Programmer from **£134**

Video

16 lines, 32/64 ch from **£104**
24 lines, 84 ch from **£265**

Disc Controllers

Versafloppy S/D **£198**
Doublor D/D **£280**

Mainframes

We are the sole UK Distributor for Integrand Mainframes and Disc Enclosures, available in nine models including Desk Top and Rack Mounting, with or without provision for Disc Drives. All units totally enclosed, painted on all external surfaces and complete with power supply etc.

Software

CP/M 1 & 2, MP/M, PL/1, C-BASIC 2, M-BASIC V5, XYBASIC, FORTRAN 80, COBOL 80, CIS-COBOL, PASCAL/Z, PASCAL (UCSD), PASCAL M/T, Forth, MAC, ZSID, Disassembler, Wordstar, Datastar, Magic Wand, Wordmaster, Supersort etc etc.

RAM

Dynamic RAM 16K-64K from **£205**
Static RAM 8K-64K from **£95**
Memory Manager **£52**

I/O

2S/4P prov 4K RAM/4K ROM **£169**
2S/2P or 2S/4P or 3P/1S or 4S/2P from **£135**
Analogue 8 or 12 bit from **£287**
Optically isolated I/O **£114**
IEEE 488 Interface **£350**

Miscellaneous

Real Time Clock **£180**
High Dens Graph/8K RAM **£333**
Hi-Tech Colour **£295**
Motherboards — various from **£34**
Extender Board/logic probe **£39**
Maths Board AMD 9511 **£330**

WRITE OR PHONE FOR CATALOGUE
PRICES EXCLUSIVE OF VAT

• Circle No. 306

Video Genie System

16K USER RAM
12K MICROSOFT BASIC

£330
+ VAT



The Video Genie System:

- Plugs into video monitor or UHF T.V.
- Fully TRS-80 software compatible.
- Self contained PSU, modulator and cassette.
- "QWERTY" keyboard.
- 1 year guarantee.
- Fully expandable to operate disks under the excellent VTOS 2.3 operating system.
- Disk based full BASIC compiler available.
- Uses well-proven Z-80 micro processor.
- Manuals supplied.
- Ideal for both beginner and the professional.

DETAILS BY RETURN FROM

Business Technology

74 Allderidge Avenue, Chanterlands Avenue
North, HULL, N. Humberside.
VAT No. 347 4060 62

• Circle No. 307

PET COMPUTERS Southampton

New 4000 series PET's now available (identical to 3000 series but with SUPERPET operating system)

For a limited period at the following prices

4008N £405 4032N £620 C2N Cassette £55

4040 Disk Unit £625 3022 Printer £395

2001-8S Small Keyboard PET £395

TENSAI Cassette Deck with counter, CB2 sound £70

TOOLKIT £45 or £35 with computer

We also HIRE Commodore equipment by the week

8K £23, 16K £26, 32K £30, includes manuals,

tutorials, games (Invaders, Microchess) & Cassette

Floppy Disk Unit £30, Printer £30

Some new and ex-hire 3000 PET's available

e.g. 32K £565 16K £475

Matching beige dustcovers for all models £4

Software (Commodore, Petsoft), books and many

other PET related items stocked

All prices exclude VAT

Official Commodore Dealer

SUPER-VISION

13 ST JAMES ROAD, SHIRLEY, SOUTHAMPTON

Telephone (0703) 774023

After hours (0703) 55488

• Circle No. 308

MicroStyle

9 St. Peters Terrace,
Lower Bristol Rd.

Bath, BA2 3BT.

Telephone: (0225) 334659

Telex: 44371 (KEMP-G)

After hours: Tel: (0761) 33283

sells Pet for home, educational and
small business applications

Software Packages

Specialists in the supply of:

- ★ PETS and Peripherals
- ★ Computhink
- ★ Epson
- ★ TCM
- ★ Video Genie
- ★ OHIO

THE "PET" NEW REDUCED PRICES

8K £415
16K £525 +
32K £650 VAT EXT CASSETTE £49.50



Dual Disc Units

Computhink (dual drive)
400K

£795

Computhink (dual drive)
800K

£995



TCM 100 & 200
Thermal Printer
with
graphics

TCM 100 (40 col) £240 | TCM 200 (80 col) £259

Interfaces —
Pet £45.00
TRS-80 £55.00
Apple £45.00
Apple G £55.00

PET SOFTWARE

VIDEO GENIE
16K Level II Z80
with integral Cassette
Deck. Fully TRS80
compatible.
Extra RAM available.
£330

**WE WOULD
BE PLEASED
TO MEET
YOU AT
BATHS OWN
MICRO
SHOW DEC.
19th**

Ohio CI-P

4K RAM

Extra
4K
RAM
£30



£220

Special
Offers!

PET BUSINESS SYSTEM

comprising
CBM 32K Micro
computer. COMPUTHINK Disk Drive.
Tractor Feed Printer and all cables

£1750

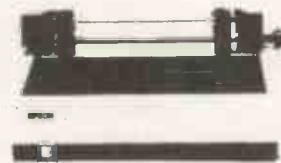

**POUND
SIGN &
NEW
GRAFTRAX
OPTIONS
NOW
AVAILABLE**

Dot-Matrix Printer with PET Graphics. Prints 80 columns on plain paper at 90 characters/second. Adjustable tractor
• Upper/lower case • Double width printing • Micro controlled • Self test • Heavy Duty Print Head using Jewell Bearings for long life • Made by Shinshu Seiki an affiliate of Seiko Watch Co of Japan. Interface: Centronics Parallel. Options: PET, APPLE Serial. SUPERBRAIN TRS 80

EPSON TX80B £359 Inc. INTERFACE AND CABLE

Please add £10
Security delivery
on computers etc
plus 15% VAT
on all prices

One year guarantee on all machines

SEND S.A.E. FOR LIST OF BOOKS & SUNDRIES

DEALER ENQUIRIES WELCOME. FURTHER DISCOUNTS
MAY APPLY

WHY NOT FIND OUT MORE?

TEL: BATH (0225) 334659

AFTER HOURS (0761) 33283

• Circle No. 309

PRACTICAL COMPUTING January 1981

Experts in Microcomputer Systems



WARREN POINT LIMITED
Babbage Road, Stevenage,
Hertfordshire SG1 2EG
Telephone: Stevenage (0438) 66311

Whatever your business, and whatever its size, Warren Point can save you time and money. By experience, care, and immense computing knowledge gained over 12 years of business.

• Circle No. 311



**CRYSTAL ELECTRONICS
CC ELECTRONICS**

THE SKY'S THE LIMIT FOR YOUR SHARP MZ80K with SHARP CP/M 2.21 (XTAL)

CP/M is the trade mark of Digital Research.

This sophisticated interactive program development system will give your home computer **BUSINESS/INDUSTRIAL** potential.

Basic CP/M facilities include:

- Dynamic file management
- General purpose editor
- SHARP CP/M 2.21 (latest version) on disc
- XTAL Monitor and Operating system
- 7 Digital Research manuals
- CP/M Handbook (by RODNAY ZAKS)
- 12 months guarantee and up-dates

YOUR SHARP CP/M 2.21 (XTAL) PACKAGE INCLUDES
• Hardware modification (if fitted by a SHARP dealer does NOT break the guarantee)

- Fast assembler
- Advanced debugging utility

IF YOU ARE A SHARP MZ80K OWNER, CP/M 2.21 (XTAL) IS A MUST FROM £200.00

Ask your SHARP dealer for further details or contact
CRYSTAL ELECTRONICS

**CP/M SOFTWARE HOUSES - XTAL CAN HELP YOU
ESTABLISH YOUR SOFTWARE ON THE SHARP**

Members of Computer Retailers Association & Apple Dealers Association

Shop open 0930-1730 except Saturday & Sunday

40 Magdalene Road, Torquay, Devon, England. Tel: 0803 22699

Telex 42507 XTAL G

Access and Barclaycard welcome.



COMPUTERS
AND
COMPONENTS



• Circle No. 312

3D

Digital Design and Development

18/19 Warren Street · London W1P 5DB Tel: 01 387 7388

CBM PET SHARP MZ-80K

**Specialist Suppliers of
Complete Systems for
Industrial and Laboratory
Monitoring and Control.**

**Please note our new address.
Callers welcomed for demonstration
and/or discussion.**

SHARP MZ-80K INTERFACES

- Parallel Printer Interface £110
- Serial Printer Interface £150
- Bi-Directional Serial Interface £210
- 16-Channel A/D Converter Unit £280
- Fast Data Acquisition System -
40,000 readings/sec. 4 analog channels
IN and 4 channels OUT. P.O.A.

PET INTERFACES

IEEE-488 Compatible Units

- 16 Channel 8-Bit A/D Converter £300
- 8 Channel 8-Bit D/A Converter £350
- 8 Channel 12-Bit A/D Converter £600
- 12-Bit D/A Converter P.O.A.
- X-Y Analog Plotter Interface £200
- Digital Data Input Unit, 64 Bits £400
- Digital Data Output Unit, 64 Bits £350
- 16 Channel Relay Unit £350

Also...

- USER Port Converter A/D plus D/A £200
- Fast Data Acquisition System
40,000 readings per sec. 4 A/D + 4 D/A P.O.A.

All units boxed complete with IEEE-488 address internally selectable, with integral power supply, cables, switch, fuse, indicators and illustrative BASIC software.

TERMS: All prices EX-VAT. P&P extra.
Cheques should be made payable to
3D Digital Design & Development.
All goods supplied under 90 days warranty.
CUSTOM DESIGN UNDERTAKEN



• Circle No. 313

From Newtronics

THE NEW EXPLORER / 85 SYSTEM

EXPLORER / 85 PROFESSIONAL COMPUTER KIT



**An inexpensive
8085, S100 Based
Computer System designed
for maximum flexibility
Now available with 8" Floppies**

The EXPLORER/85 offers you real design flexibility — you can build the exact system you require. EXPLORER/85 can be your Beginners System, OEM Controller or IBM formatted 8" Disc System. You don't buy more than you need. Prices start from £85.

Here's the line up:

Intel 8085 microprocessor, 8355 as a really powerful 2K Monitor system. 8155 RAM I/O all on one single Mother board with room for RAM/ROM/PROM/EPROM and two S-100 pads (expands to six), plus plenty of prototype space.

The 8085 is 100% compatible with the 8080 but 50% faster. The 8355 ROM 2K monitor system includes cassette interface with tape control. Two 8-bit programmable I/O ports, automatic baud rate selection, labelling of cassette files, etc. 8155 RAM I/O features ¼K 'scratch pad'. Two programmable 8-bit and one programmable 6-bit I/O ports plus programmable 14-bit binary counter-timer. Plus many other features which cannot be included due to lack of space.

You can purchase the EXPLORER/85 Mother board (level A) at this point for as little as £85 or we'll supply it with address decoding and data drives plus wait state generator and separate regulators (level B), 4K Workspace (level D), 8K Microsoft Basic in ROM for £233 in kit form of £293 assembled and tested.

If you don't possess a VDU you can add our Keyboard Terminal (less monitor) which features a full ASCII keyboard with upper and lower case with cursor control, Video Display board which is microprocessor controlled giving 64 or 32 (on TV) Characters by 16 lines adding up to a full computer system having 4K workspace at a special price of £299 (less P.S.U. and monitor/TV).

Compare these prices carefully and you'll find you are actually getting more for your money.

4K space not enough? Then it's 'JAWS' for you (see below) and you can go up to 64K in 16K steps. We'll let you have a 16K EXPLORER/85 for only £399.

Like a Floppy Disc system? We now have an 8" Drive system with CP/M. We will quote you for a complete system either in kit form or assembled ready to go.

LET NEWTRONICS HELP YOU EXPAND YOUR SYSTEM 8" FLOPPY DISC SYSTEM

8" Control Data Corp Professional Drive

* LSI Controller * Write protect * Single or Double density * Capacity 400K Bytes (SD) 800K Bytes (DD) unformatted * Access time 25ns. Price £350.

DISC CONTROLLER I/O BOARD

Controls up to 4 Drives * 1771 ALSI (SD) floppy disc controller * On board data separator (IBM compatible) * Z716 PROM socket included for use in custom applications * On board crystal controlled * On board I/O baud rate * Two serial I/O ports * Autoboot to disc system when system reset * Generators to 9600 baud * Double-sided PC board (glass epoxy). Price £150.

DISC DRIVE CABINET WITH POWER SUPPLY

De Luxe steel cabinet to house single drive with power supply unit to ensure maximum reliability and stability. Price £79.

DRIVE CABLE SET-UP FOR TWO DRIVES

Price £19.00

SAVE £30 by purchasing complete single drive system. One 8" drive, F.D.C. board, cabinet/PS.U. and cables. Regular price £598, Special price £568.

CP/M 1.4 £75. CP/M 2.2 £98. Extended Microsoft Basic £213 (Includes CP/M 2.2).

64K 'JAWS' S100 DYNAMIC RAM BOARD

We offer you — Hidden refresh ... fast performance ... lower power consumption ... latched data outputs ... 200ns 4116 RAM's ... on board crystal ... 8K bank selectable ... fully socketed ... solder mask on both side of the board.

Designed for 8080, 8085 and 280 bus signals ... works in Explorer/85, Tuscan, Horizon, Sol, as well as all other well-designed S100 computers.

	KITS	WIRED & TESTED
16K	£149	£169
32K	194	£214
48K	£239	£259
64K	£284	£304
16K expansion	£45.	

ELF II

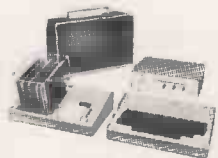

SPECIFICATION

* RCA 1802 8-bit microprocessor with 256 byte RAM expandable to 64K bytes.

* RCA 1861 video IC to display program on TV screen via the RF Modulator Single Board with Professional hex keyboard — fully decoded to eliminate the waste of memory for keyboard decoding circuits. Load, run and memory protect switches. 16 Registers. Interrupt, DMA and ALU. Stable crystal clock. Built-in power regulator 5-slot plug in expansion bus (less connectors).

SPECIAL XMAS OFFER £39.95

ELF II BOARD WITH VIDEO OUTPUT FEATURING THE RCA COSMAC 1802 cpu

STOP reading about computers and get your "hands on" an ELF II and Tom Pitman's short course. ELF II demonstrates all the 91 commands which an RCA 1802 can execute, and the short course speedily instructs you how to use them.

ELF II's VIDEO OUTPUT makes it unique among computers selling at such a modest price. The expanded ELF II is perfect for engineers, business, industry, scientific and educational purposes.

ELF II EXPANSION KITS

Once you've mastered your ELF II you can then expand it to a full 64K microcomputer with our range of ELF II expansion kits. — Hardware — Firmware — Software — Manuals.

NOW AVAILABLE BASIC LEVEL III with R.P.N. Maths package. Both cassette and EPROM versions.

SEND SAE FOR COMPREHENSIVE BROCHURE

Please add VAT to all prices. P&P extra. Please make cheques and postal orders payable to NEWTRONICS or phone your order quoting BARCLAYCARD. ACCESS number.

We are open for demonstrations and Sales. Monday-Saturday, 9.30 a.m - 6.30 p.m Near Highgate Underground on main A1 into London.

Oki Microline 80



Small, light,
quiet matrix
printer.

40, 80 or 132 cols.
6 or 8 lines per inch.

96 ASC II + 64 graphics character set
with Centronics compatible interface
£369

Epson MX 80

— the worlds first printer
with disposable print head

*9 x 9 dot matrix * Logic Seeking * Bi-directional
* 96 ASCII Characters * 64 Graphics and 8
International Characters * Centronics I/P with
optional RS232 and IEEE 488 * Four print
densities 40, 80, 66 or 132 columns * Multiple
type founts * Self Test * Self Diagnostics
* Buzzer for end of paper and bell code error

ONLY £399

TVM-10 MONITOR



£99.50
IDEAL FOR APPLE NASCOM
U.K. 101, ETC.

- Designed for monitoring computers, closed circuit TV and Video Tape Recorders
- 10" black and white video monitor
- 10 MHz band width
- High-quality metallic cabinet
- Dimensions: 9" x 9" x 9½"

Trade Enquiries Welcome



Newtronics

255 ARCHWAY ROAD, LONDON, N.6
TEL: 01-348 3325

• Circle No. 314

MAP SOFTWARE FAST MAIL

SALES LEDGER - Open item, 350 accounts, 3500 transactions, includes sales invoicing, requires 64K and 2 floppy drives - £300

PURCHASE LEDGER - Ditto (no invoicing) - £300

NOMINAL LEDGER - 250 heads of analysis can be set by the user, 2500 transactions, P & L, Balance Sheet and Trading Account - £300

ACCOUNTS PRODUCTION - Allows production of accounts from the nominal, after allowing for accruals, prepayments and up to 20 closing stock values - £110

STOCK RECORDING - In - Out balance system, receipts, orders, costings, below re-order levels, etc. - £250

INCOMPLETE RECORDS - Designed for the professional accountant for production of accounts from Vouchers, Statements, Private Entry Documents etc. - £550

As above including word processing for customisation of clients accounts - £900

NEWSBOY - An aid for Newsagents, keeps records of news-rounds, customer accounts etc. - £425

JOB COSTING - Creation, Post Purchases, Invoices, Labour, Stock, Delivery Notes, Status and Profitability - £550

MAP HARDWARE

DOLPHIN BD 80 PRINTER - Full feature, serial or parallel interface (state which please) - £425 + cable

TEXAS OMNI 810 - Printer, very reliably, good for heavy duty utilisation, full 132 character width - £1450 + cable

ANADIX 9500 - Superb fast matrix printer with lots of features including 132 column, character etc., serial interface - £895 + cable

We also supply SUPERBRAIN & DYNABYTE Computers, Desks, Stands, Work-Stations, Stationery, Media etc., etc.

Please rush me the following SOFTWARE / HARDWARE:-

Name _____

Address _____

Please make cheques payable to MAP as address below. Please allow 7 days for delivery. Hardware orders add £15 packing/ delivery.

**BELGRAVE ESTATE
HONEYWELL LANE
OLDHAM, MANCHESTER
Tel: 061-633 3804/5**



COMPUTER SYSTEMS LTD.

small enough to CARE - large enough to COPE

• Circle No. 315

SD SYSTEMS PLUS CAP-CPP MICROCOBOL

Mainframe performance for Micro prices

SD100 - 64K RAM, twin 8" .5MB diskettes 4Mhz clock, two powerful Z80 processors, S100 bus, top quality screen - £4148.
SD200 - as above but twin 1MB diskettes - £4700.



NEW RELEASE

SD610 - SHUGART 10 MB WINCHESTER DRIVE WITH QUME 1 MB DISKETTE BACK UP. CAPABLE OF SUPPORTING UP TO FIVE USERS FROM ONLY £6,400

ALL CAP-CCP standard packages plus exclusive Micro cobol Quantity Surveyors package available now from:

BARCELLOS LTD.

running on probably the finest and most cost effective composite Microprocessor package available in the U.K. today, the

SD 100/200

"WORDSTAR" a comprehensive word processing package is available for a further £250, the addition of a second work station, extra 64K memory and Cosmos multi user operating system costs under £2000 and easily allows dual operation.

STOP PRESS!
TEXAS INSTRUMENTS
810 PRINTERS ONLY £1097 EACH
O.E.M.s PLEASE NOTE

BARCELLOS LTD.
(DATA SYSTEMS)
KIMBERLEY HOUSE,
VAUGHAN WAY,
LEICESTER
Tel: (0533) 26584-5

OVER A WIDE MIDLANDS AREA WE ASSUME FULL RESPONSIBILITY FOR ALL ASPECTS OF YOUR SYSTEMS INCLUDING HARDWARE AND SOFTWARE MAINTENANCE

• Circle No. 316

Westwood Computers

117 TENNANT STREET, FIVE WAYS,
BIRMINGHAM

In our new showrooms
and training centre you can see
the complete

Z Plus micro computer systems
with word processing, accounts packages,
stock control etc.

We're offering practical courses in
programming - BASIC, PASCAL and
COBOL, The Electronic Office, Computer
Accounting, Newcomers Guide to the
Computer World, and of course we have
one of the most extensive ranges of
computer books and services in the city.
Browsers welcome.



AUTHORISED APPLE DEALER



021 632 5824
On the street parking
always available.



• Circle No. 317

Write better programs for your pet using

THE PET SUBROUTINE LIBRARY



An anthology of PET subroutines including:

Data input, special input routines to ensure correct data input — Reducing input errors by use of check digits — Date input verification and storage, avoid errors in date input — Screen formatting output — High density plotting, graphs, barplots and general purpose machine code point plotting routines — General purpose screen handler, a subroutine to perform all data input and output on the screen — Array sorts: bubblesorts, Sheilmetzner, and replacesort — Sorting and merging large disk files — Fast machine code sort package, including a binary search, data input and output to an array and machine code sort (100 element array in a couple of seconds) — Sorting with linked lists, stores data both in sorted and logical order — Sorted output on the printer, ideal for producing indexes — Sequential access disk files — Machine code sequential disk access, some ideas and tips on fast disk access — Random access disk files, an introduction with subroutines to write a random access file, either by record number or by key index — Disk utilities, display block map of disk or print contents of a disk sector — Menus for selecting options and linking programs together — Plus miscellaneous utility programs including repeat key, trace and screen printer.

Price £10.00 all inclusive

3040 format disk with all the subroutines from "LIBRARY OF PET SUBROUTINES"
Price £10.00 inclusive

THE PET REVEALED

Best selling reference book for the PET. Price £10.00

Cheques payable to Computabits Ltd

COMPUTABITS LTD,
P.O. BOX 13, YEOVIL, SOMERSET. Tel Yeovil 26522



• Circle No. 318

CB -the countdown has begun!

Get ready for Citizens Band radio with a brand-new magazine that tells you everything you want to know. We show you how CB works and how to use it. We've got a full colour spread on customised American trucks. We offer special deals on CB World sweat shirts, T shirts, caps and badges. And we ask: should we use US Truckspeak or create our own English jargon? And what about the radio amateur - and the aircraft modeller? Tell us what you feel. Get involved - and get this very first issue of CB World, it's a big ten four!

Published by IPC - the world's largest publisher of radio and electronic magazines.



FIRST ISSUE
OUT NOW 60p



"THIS BOOK IS EXCELLENT" - CLIVE SINCLAIR

This unique book contains 30 programs all designed to fit in the basic 1K version of the SINCLAIR ZX80!!

With this book you will realise that the ZX80 is more powerful than you ever imagined! 112 pages packed full of solid information!

BLACKJACK - actually contains a full pack of cards, shuffles them, keeps track of the dealer and player totals, and the money bets, all within 1K.

DR. ZX-80 - a truly conversational program: DR. ZX-80 is your personal computer analyst.

LINE RENUMBER - an invaluable program which automatically renumbers lines and puts order to your programs.

MEMORY LEFT - an incredible routine especially useful with only 1K, which lets you know to the byte how much memory is left. This also illustrates USR routines.

GOMOKU - the computer challenges you to this complex Japanese game. Incredibly this program including display of the 7x7 board fits into 1K - it only does so because it uses the display as memory!

Other programs included are **HORSE RACE**, **LUNAR LANDER** (with moving spaceship display), **NOUGHTS AND CROSSES**, **NIM**, **SIMPLE SIMON**, **HANGMAN**, **LIFE**, **MASTERMIND**, **PINCH** and 16 others!

£6.95 OTHER BOOKS IN PREPARATION INCLUDE
available by mail 'ZX-80 MACHINE LANGUAGE PROGRAMMING'

(plus 50P p&p) order only



MELBOURNE HOUSE
PUBLISHERS

Orders to: 131 Trafalgar Road, London SE10

Correspondence: Glebe Cottage, Glebe House, Station Road, Cheddington, Leighton Buzzard, Beds.

Please send me copy/ies of '30 Programs for the ZX-80: 1K'

NAME:

ADDRESS:

POSTCODE:

Please enclose cheque or P.O.
for £7.45 per copy.
Orders outside the U.K. £7.95

PCI/81

• Circle No. 319

CHROMASONIC electronics

48 JUNCTION ROAD, ARCHWAY, LONDON N19 5RD 50yds FROM ARCHWAY STATION & 9 BUS ROUTES
 TELEPHONE 01-883 3705 01-883 2289

YOUR SOUNDEST CONNECTION IN THE WORLD OF COMPONENTS AND COMPUTERS

PETS & SYSTEMS

- 8N 8K RAM £399
- 16N 26K RAM £499
- 32N 32K RAM £599
- CASSETTE DECK £55

343K Twin Floppy Disk
£695

NEW 32K with 80 col Screen £825
 Twin Disk Drive 950K £895

All with new keyboard
and green screen

- Friction Feed Printer £375
- Tractor Feed Printer £425



COMPLETE 32K SYSTEM £1789

MEMORY EXPANSION KIT

Suitable for UK101. Superboard expansion using 2114's each board has 16K ram capacity kit contains:

- ★ On board power supply
- ★ 4K Eprom expansion
- ★ Fully buffered for easy expansion via 40 pin socket
- ★ 8K kit £89.95
- ★ 16K kit £122.95
- ★ Printed Circuit Board £29.95
- ★ 40 pin - 40 pin header plug £8.50



NEW SHOP

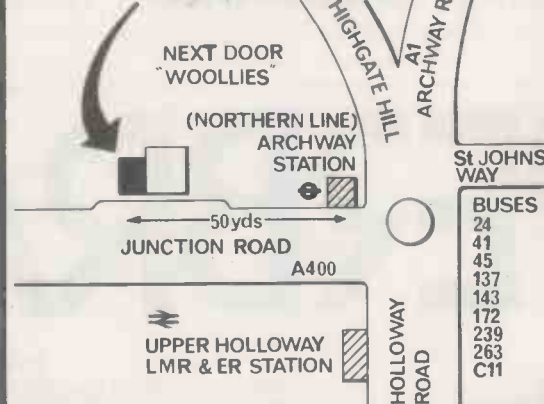

VIDEO GENIE

VIDEO GENIE based on TRS80



Utilises Z80, 12k level II Basic, Integral Cassette Deck, UHF O/P. 16k RAM, all TRS80 features

£289

CASES

Available for U.K. 101, Superboard Nascom. Appx. DIM. 17" x 15" 435 x 384 mm

PRICE £24.50

Post & Packing £1.50

UK101 P.P.I.

BUILT & TESTED. INTERFACES TX80 PRINTER DIRECT, CAN BE PROGRAMMED TO OPERATE RELAYS, MOTORS, VARIOUS OTHER PERIPHERALS 'CENTRONICS COMPATIBLE' PLUGS INTO IC SOCKET. RED IIIIII DISPLAY FULL DOCUMENTED £29.95

UK101

£179 IN KIT FORM
 £229 READY BUILT & TESTED
 £255 COMPLETE IN CASE

5K EXPANSION (8 x 2114) now only **£18.00**

- ★ No extras required
- ★ Free sampler tape
- ★ Full Qwerty keyboard
- ★ 8K basic
- ★ Ram expandable to 8K on board (4K inc)
- ★ Kansas City tape interface
- ★ NEW MONITOR ALLOWS FULL EDITING & CURSOR CONTROL

£22.00



PRINTERS

EPSON TX-80
£349

Dot-matrix printer with Pet graphics interface: Centronics parallel, options: PET, Apple and serial.

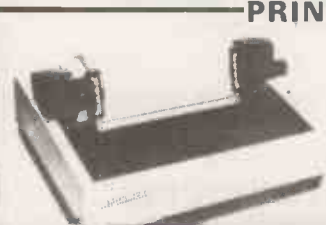

Please add VAT 15% to all prices. Postage on computers, printers and cassette decks charged at cost, all other items P&P 30p. Place your order using your Access or Barclaycard. (Min. tel order £5). Trade and export enquiries welcome, credit facilities arranged.



• Circle No. 320

V. & T. ELECTRONICS

**NASCOM 2
16K RAMB BOARD
V & T ASSEMBLER**

KIT	BUILT
330	385

Z-80 A CPU, 8K BASIC, 2K MONITOR
EASILY & ECONOMICALLY EXPANDABLE &
BRITISH.

NASCOM 2	210	250
16K RAMB BOARD	130	150
3 AMP POWER UNIT	32.50	35
GRAPHICS ROM		15
8 x 4116s TO 32/48K		25
V & T ASSEMBLER ON TAPE		12.50
VERO 19" FRAM/OR MICROCASE		25
		512.50

DISCOUNT IF BOUGHT
COMPLETE

62.50

£450.

I/O BOARD	45	55.
EPROM BOARD (UP TO 32K + BASIC)	55	67.50
NASCOM IMP PRINTER 80CPS		325.

DOUBLE SIDED, DOUBLE DENSITY. 5¼"
DISCS CONTROLLER CARD (NAS BUS
COMPATIBLE) PSU + CP/M. AVAILABLE
MID. NOV. POA.

V & T ASSEMBLER PROGRAM
FULLY RELOCATABLE. SUPPORTS ALL
STANDARD PSEUDO OPS + MNEMONICS.
RUNS UNDER B BUG. T4. NAS SYS 1+3.
ON TAPE **£12.50**

PIO OPTION	£12	ZEAP EPROM	£50
VART OPTION	£16	TAPE	£30
CTC OPTION	£14	NAS DIS	£37.50
NAS SYS 3	£40	NAS DEBUG	£15
NASPEN		£30	

MEMORY

8 x 4116 200 ns DRAM	£25.00
TRS80 U/GRADE KIT	£26.00
1 x 2708 1K x 8 EPROM	£ 4.00
1 x 2716 5V 2K x 8 EPROM	£ 6.50

PLEASE ADD V.A.T. AT 15%

82 CHESTER RD LONDON N19 5BZ TEL (01) 263 2643

• Circle No. 321

SUPERBRAIN™



HARDWARE

64K CPU, Dual Double Density Mini-Floppies 320 KB
Optional extra capacity to 1.6MB
Dual RS232 communications ports
Dynamically Focused 12" CRT. Full ASCII keyboard
CPM 2.2 operating system. Day 1 Maintenance £155 pa.

SOFTWARE

Fully integrated
accounting system
from invoicing to
trial balance/final
accts, or individual
packages supplied on
a building block basis

- payroll
- invoicing/stock control
- sales ledger
- purchase ledger
- nominal & final accts
- word processing

£1495
COMPLETE
(EX VAT)

CONSULTANCY — SPECIAL PROGRAMMING — TRAINING

for further details, please contact: —

ATLANTIC MICRO SYSTEMS
72 HONOR OAK PARK
SE 23 (close Honor Oak BR stat)
TELEPHONE: 01-904 3074

SUPERBRAIN™ is the registered trademark of Intertex Data Systems.

• Circle No. 322

Get the latest on PET...



Dial 01-579 5845.

Adda make it their business to get in first on all that's best and new in PET hardware and software... and in finding out how to make the latest advances work more profitably for you.

All the advice, assistance and arrangement of demonstrations you could ask for are there for the taking. And that's just for starters. Long term Adda look after your future requirements with software, full engineering support and maintenance contracts that can include machine loan.

In addition to the 16k PET 3016 and 32k PET 3032, Adda offer you the new 32k PET 8032—with 80 columns, 12-inch screen and a keyboard that really gets down to business. Recent advances make possible some exciting applications for these mighty micros.

Link the 32k PET up to the Wordcraft word processing program and you have a very sophisticated word processing system for less than £4000. It's a word processor and more—because it can also be used as a small business machine.

The Wordcraft program comes on a mini floppy disc ready for use on a Commodore 3040 diskette drive. The whole system gives you word processing to standards achieved by expensive

purpose-built machines; and you can use a large selection of output printers including dot matrix, golfball and daisy wheel. So much for words—now for some action: phone 01-579 5845.

If you're looking for mainframe access, the Communicator 1 mainframe-PET link enables file transfer to be made in both directions... with a PET Communicator system configured with either dual floppy disc or cassette tape drive and a printer.

Files transferred from mainframe to PET can be manipulated locally and data transfer monitored on the PET screen. It's a fast way of cutting costs on bureau time share—and it also doubles up as a fast normal terminal. The Communicator 1 mainframe-PET link paves the way to big cost savings. Your first step is digital input to 01-579 5845.

More cost savings can be realised when you link up three to eight PETs to one Commodore disc drive and a printer using Mupet (Multi-User PET)—and you don't have to make any program changes. As a Mupet dealer, Adda can put you fully in the picture. Just phone 01-579 5845 for a demonstration of Mupet being put through its paces.



adda

Adda Computers
14 Broadway
West Ealing
London W13 0SR
Entrance in
Kirchen Road

we add up to a great deal.

• Circle No. 323

DATRON of SHEFFIELD

Cromemco the ultimate name in micros



DATRON import direct from Cromemco, California.
 DATRON can supply Nationwide.
 DATRON can provide maintenance nationally
 DATRON can give you the realistic prices.
 DATRON have in stock:-

SYSTEM2 64K £2147

SYSTEM3 64K £3746

Z-2H HARD DISC 10M £5373

DATRON can supply Systems 2 and 3 with
 Multi-Tasking facilities.

DATRON easily accessible - in the centre of
 the country.

Write or telephone for FREE colour brochure on System 3 or Z-2H.
 We use Cromemco for our own business, why not call in for a demonstration.



DATRON MICRO CENTRE
 DATRON INTERFORM LTD

2 Abbeydale Road, Sheffield S7 1FD.
 Telephone 0742-585490. Telex 547151.

• Circle No. 324

Does your microcomputer suffer from hiccups?

If so, quite often the cause of irregular performance or breakdown is very simple.

It's probably a high voltage spike in the electricity supply, called a transient, affecting the performance. Heavy electrical loads in the vicinity of your microcomputer (from domestic electrical appliances to office photo-copiers) can often cause voltage transients, which in turn, play havoc with both hardware and software.

The Reguvolt 'P' Model Constant Voltage Transformer provides the answer to a very simple yet aggravating problem, offering the following benefits to safeguard your supply sensitive computer and equipment.

- Transient suppression — gives software and hardware protection.
- Brownout protection — prevents micro interruptions and system crashes.
- Isolated secondary circuitry — gives complete electrical isolation between mains and computer.
- Fast voltage stabilisation — prevents VDU screen drift and complete system failure.



- Automatic overload current limited — protects equipment against damage during a fault condition.
 - Low frequency mains harmonics removed, preventing VDU flicker and circuit overload.
- The complete range of Reguvolt 'P' models, from 1/2 to 2 amp ratings (ie. 120VA to 500VA) are available from stock.
- Should you require further details, please fill in the coupon, or, if you prefer, give us a call.



Cetronic Limited
 Hoddesdon Road, Stanstead Abbots,
 Ware Herts SG12 8EJ England
 Tel Ware (0920) 871077 Telex 817293

Please send me further information on your range of Reguvolt 'P' Model Constant Voltage Transformers.

Name

Company

Address

Telephone PCI/81

• Circle No. 325

COMPUTECH for apple

COMPUTECH for **ITT**

Well proven software for business applications on the
ITT 2020 and Apple microcomputers.

Prices excluding V.A.T. for cash with order, F.O.B. London NW3

PAYROLL	(300+ Employees, 100 Departments, hourly, weekly, monthly. Very powerful but easy to use).	£375
SALES LEDGER	(500+ Accounts, 100 Departments).	£295
PURCHASES LEDGER	(500+ Accounts, 100 Departments).	£295
GENERAL (OR NOMINAL) LEDGER	(1000 Accounts, 100 Analyses, multi-purpose package). Job costing etc.	£295
UTILITIES DISK 1	(Diskette patch, slot to slot copy, zap etc).	£20
APPLEWRITER	(Word Processing, see below for U/L case).	£42
VISICALC	(Financial Modelling, Costing, Analysis).	£95
CAI	(Converts Apple pictures for ITT display).	£10

Over 500 packages in use, fully supported by us.

AND NOW HARDWARE!

LOWER & UPPER CASE CHARACTER GENERATOR £50
Replaces character generator to display upper and lower case characters on screen, includes patches to work with Applewriter, supplies the missing link! Specify Apple or ITT.

COMPUTECH DIPLOMAT H/S SERIAL INTERFACE £80
This card has been designed and built to the same professional standards that have resulted in the success of our software. The DIPLOMAT observes the proper "handshaking" protocol so that you can drive fast printers and send and receive data from other peripherals at high speeds without loss of data. Switch (& software) selectable baud rates to 19200 and many other options. Plug compatible with 'terminal' or 'modem' wired peripherals. Guaranteed.

MICROLINE M80 PRINTER £425
This neat, reliable machine prints at 10 characters per inch, 80 characters on an 8 inch line, or 40 expanded characters, or 132 very readable characters, upper and lower case and graphics, 9 x 7 dot matrix, 6 or 8 lines per inch. Parallel interface is standard, serial optional. Both friction and sprocket feed are standard, tractor optional. We can also supply the parallel interface card for Apple System computers for £80 and a driver to enable both text and graphics to be used. Optional custom colour matching for Apple or ITT. Optional character sets. *Trade supplied at very generous discounts for modest quantities.*

THE FABULOUS MICROMUX 8000 from £800
This is a brand new product, an asynchronous serial multiplexor with up to 16 ports, any one of which may communicate with any other independently, like a 'telephone exchange' for data! Built in test function. Firmware may be customised for special applications. Available in multiples of 4 ports up to 16.

COMPUTECH SYSTEMS

168, Finchley Road, London NW3 6HP. Tel: 01-794 0202

AGENTS THROUGHOUT THE UK AND OVERSEAS

Micro-Processor Development System for under **£400**

Small Systems offer an S100 card containing up to 8K static RAM (1K increments) accessible from both the system and externally from PROM plugs on flying leads. Simulates up to 8 2708's or 4 2716's sockets and it will access system RAM as if it were ROM or PROM. Allows full use of all CPM facilities. CPM compatible assemblers for: 8080A; 8048 family; 8085A; 6800; 6801; 6802; 6803; 6809; Z80; Z8000 all at £85 each. Development Board £295. Also RCA 1802 family.

no more time consuming PROM programming & erasing !!



small systems engineering limited

2-4 Canfield Place London NW6 3BT Telephone 01-328 7145/6 Telex: 8813085 (Abacus)

• Circle No. 327



MANNESMANN TALLY

Mannesmann Tally, one of the world's leading manufacturers of professional computer output printers, offer for sale a limited number of genuine ex-demonstration printers at bargain prices:

T1602 160 cps bi-directional matrix printer	From £ 273
T1612 1200 Baud KSR terminal	From £ 559
T2000 200 lpm line printer	From £ 662
T3000 300 lpm line printer	From £1145

All of the above equipment carries our full 30 day manufacturer's warranty. Field maintenance contracts are available at normal rates.

To take advantage of this unrepeatable offer whilst stocks last, call
BERNARD LAVELLE on Reading (0734) 580141 now

Mannesmann Tally Ltd.

7 CREMYLL ROAD, READING; RG1 8NQ

• Circle No. 328



Vision Business Systems

FOR YOUR

SUPERBRAIN™

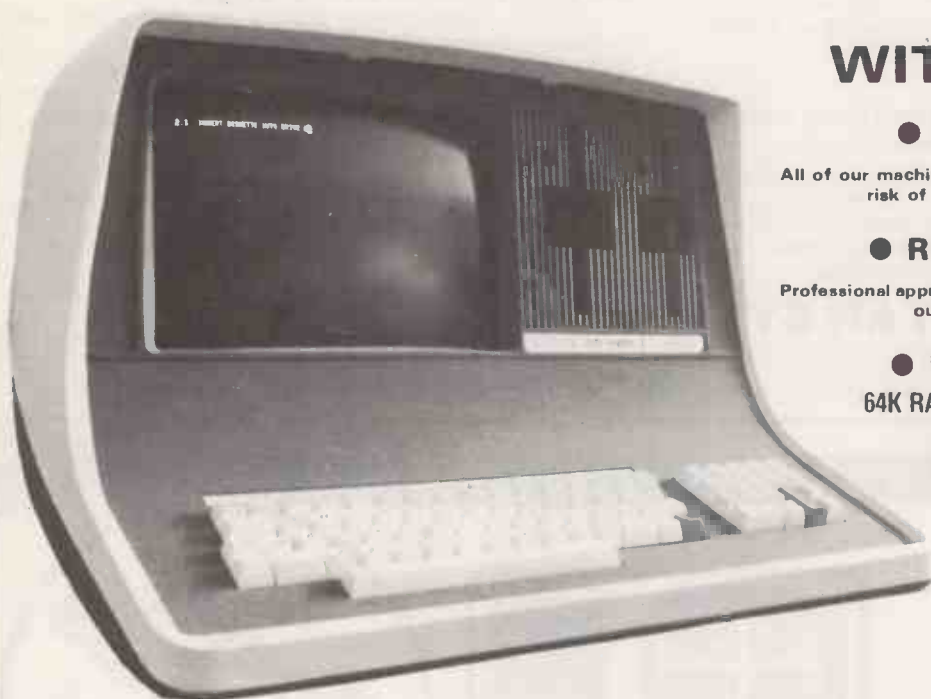

WITH THE 3 Rs

● RELIABILITY —

All of our machines are rigorously tested to minimise the risk of failure during normal operation.

● RIGHT SERVICE —

Professional approach to solving your business problems by our experienced consultants.

● RIGHT PRICE —

64K RAM with 320K Double Density
Dual Mini Floppies

ONLY £1,495

- Single desk top unit
- Dynamically focused 12 inch CRT
- 25 lines by 80 characters
8 x 8 in 8 x 12 field

**THE BUSINESS SYSTEM WITH VERSATILITY
FULL WORD PROCESSING CAPABILITY
FROM
THE 64K RAM (320K) SUPERBRAIN**

With the DIABLO 630 or RICOH RP1600 Daisywheel Printer
Using the Powerful **WORDSTAR** Word Processing Package
SPECIAL ALL INCLUSIVE PACKAGE OFFER

including all interfaces, no hidden extras

*** ONLY £3,150 ***

PLUS SOPHISTICATED APPLICATION PACKAGES designed by Professionals
Full integrated Accounting Package from only £700

CUSTOM BUILT SOFTWARE designed by our Specialist Consultants
to meet your specific requirements.

For further information please contact:

VISION BUSINESS SYSTEMS LTD.,
58 St. Peters Street, St Albans, Herts.
Tel. (0727) 33744

XITAN SYSTEMS LTD

The South's CROMEMCO experts

Need a Hard Disk System with FAST RELIABLE Backup?

Xitan now have the answer with the Z-2H plus DC300 Tape cartridge BACKUP system (S100 controller, drive, psu & software).

The Cartridge BACKUP system is available separately for existing Z-2H users (13.4 Megabyte capacity - 1 Megabyte per 5 minutes).

Utilities/Software for CROMEMCO Systems.

Tired of XFER - use FCOPY or DFCOPY. Single sided 8" copy in 54 seconds, Double sided 8" copy in 104 seconds. £50.00 each.

Need to build Assembler libraries - try LIBR at £50.00.

CP/M 2.2 and MP/M 1.1 available for System 3 and Z-2H systems.

EASYFORM. For creation/Editing of forms on the 3102 VDU with structured Basic. Forms useable from Cobol, Basic, Fortran etc. £160.00.

BUSINESS SOFTWARE.

CROMEMCO systems - a complete Business system based on

the system 3 from CAP-CPP. Phone for an appointment to see it running.

For the smaller customer, we have an integrated Sales, Purchase and Nominal system for the North Star Horizon. NOTHING fancy - but installed and running for over 7 months. IT WORKS!

WHATIF! Cash Flow, Accounts budgetting utility. Just released. Incredible value at £95.00.

Also available an Incomplete Records system for the Horizon.

SPECIALS.

Real Time Clock - S100 - 100 microseconds up to 99,999 days

£185.00 Hi-Tech S100 PAL colour card, 24 x 40 Prestel format

£295.00 Video Vector Fastlib £495.00.

Dual Tandon Double/sided 40 track minifloppy subsystem £625.00.

INTEGRATED SPECIALIST SYSTEMS.

MEDIDATA 32,000 patient Doctors' system. Installed and running. Prices from £7,500.00.

RETURNED ALE. Run a brewery? Keep track of returned ale and reclaim Excise Duty. Track down production and storage problems. Copes with 10,000+ barrels. Prices from £8,500.00.

Xitan Systems also supplies and stocks vdu's, printers, NORTH STAR HORIZON computers, Commodore Business Machines PETs, S100 boards, and books. We are here to demonstrate the range of quality microcomputer systems available for use today. Ring up for an appointment now! You'll not be disappointed. We have Osborne's Sales Ledger and Payable Ledger in source form for use on Cromemco System 3 with CBASIC2, and we can offer a customising service on these programs. Additional software includes Microsoft Basic Interpreter and Compilers, Cbasic, Macro80, and CP/M for the North Star Horizon.

XITAN SYSTEMS LIMITED

23 Cumberland Place, Southampton SO1 2BB

Telephone (0703) 38740. Hours Monday - Friday 9.30am to 5.30pm



• Circle No. 330

The Great British MICRO

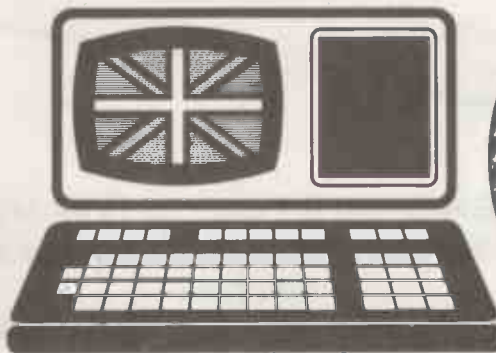

Hytec combine British Ingenuity and a user friendly interface to give

High Performance Large Disc Capacity Business & Communications Software

Hytec further provide comprehensive pre and post sales support for both hardware and software including full training, and user familiarisation

The Hytec H-series starts at around £3,500. For further information please write to or phone Hytec Microsystems Ltd., 1-3, St. George's Place, Oxford OX1 2BL.

Telephone Oxford (0865) 726644/5

HYTEC MICRO SYSTEMS LIMITED



• Circle No. 331

interface components

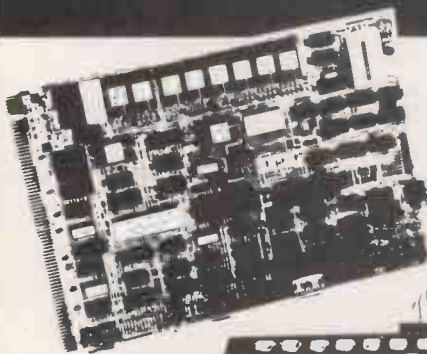

MICRO MART

ICs
EPROMs 2708 £6.50 each
EPROMs 2716 £11.50 each

MEMORIES
21L02 £0.80 each
4027 £1.50 each
4116 £3.95 each
2114 £3.00 each

Z80 DEVICES
MK3880 £9.50 each
MK3881 (P10) £6.25 each
MK3882 (CTC) £6.25 each

VOLTAGE REGULATORS
7805 80p each
7812 80p each
7815 80p each
7824 80p each
7905 65p each
7912 65p each
7915 65p each
7918 65p each
7924 65p each
Add VAT and 30p P&P to all orders

SHARP'S DESK-TOP BRAIN. MZ-80K FROM £480 Plus VAT

An amazing Z-80 controlled personal computer supplied with 78-key ASCII keyboard; 14K extended BASIC; VDU (40 characters x 25 lines); fast cassette facility; 4K monitor ROM; 80 x 50HR Graphics; and a choice of 20K, 32K or 48K of internal random access memory.

A 50-pin universal BUS connector allows the addition of printer, floppy discs, etc. There is also a built-in 3-octave music function.

20K System £480 + VAT
32K System £529 + VAT
MZ80FD (twin floppies with 208K) £780 + VAT
MZ80P3 Printer £517 + VAT
MZ80 I/O Interface £99 + VAT

Stock control & Sales/Purchase ledger software now available.

NASCOM-2

MEMORY ● 8K Microsoft BASIC ● 2K NAS-SYS 1 monitor ● 1K Video RAM ● 1K Workspace/User RAM ● On-board 8 sockets provided for memory expansion using standard 24-pin devices: 2708 EPROMs and MK4118 static RAM. MICROPROCESSOR ● Z80A which will run at 4MHz but is selectable between 2/4 MHz. HARDWARE ● Industrial standard 12" x 8" PCB, through hole plated, masked and screen printed. All bus lines are fully buffered on-board. INTERFACES ● Licon 57 key solid state keyboard (included) ● Monitor/domestic TV interface ● Kansas City cassette interface (300/1200 baud) or RS232/20mA teletype interface.

The Nascom 2 kit is supplied complete with construction article and extensive software manual for the monitor and BASIC.

EXPANSION OPTIONS

● MK4118 £10 + VAT each
16K RAM B Board £140 + VAT
32K RAM B Board £170 + VAT
48K RAM B Board £200 + VAT

£345
Built & tested incl. 16K
Ram A + VAT + £2.00 P&P

£295
+ VAT (Kit)

NASCOM-1

12" x 8" PCB carrying 5LSI MOS packages, 16 1K MOS memory packages and 33 TTL packages. There is on-board interface for UHF or unmodulated video and cassette or teletype. The 4K memory block is assigned to the operating system and video display leaving a 1K user RAM. The MPU is the standard Z80 which is capable of executing 158 Instructions including all 8080 code. Built price £140 + VAT.

Nascom-1 Kit Price
£100 Plus
+ P&P £1.50

NASCOM IMP PLAIN PAPER PRINTER

The Nascom IMP (Impact Matrix Printer) features:

- 60 lines per minute ● 80 characters per line ● Bi-directional printing ● 10 line print buffer ● Automatic CR/LF ● 96 characters ASCII set (includes upper/lower case, \$, £) ● Accepts 8½" paper (pressure feed) ● Accepts 9½" paper (tractor feed) ● Tractor/pressure feed ● Baud rate from 110 to 9600 ● External signal for optional synchronisation of baud rate ● Serial RS232 interface ● Ribbon cartridge £6.60 + VAT + 50p P&P ● 2000 sheets Fan Fold paper £18.00 + VAT + £2.50 P&P

Nascom Imp
£325
Plus VAT + £2.75 P&P

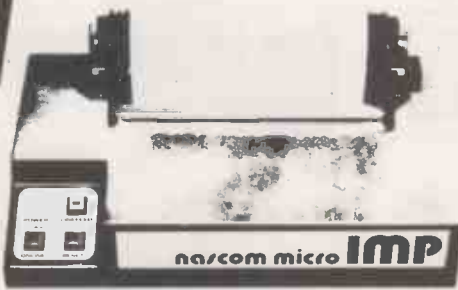

48K SYSTEM
SPECIAL OFFER
£545
+ VAT

NEW POCKET COMPUTER FOR UNDER £100 + VAT. SHARP PC-1211

It's true! A real computer that employs the BASIC programming language and fits into a pocket!

The PC-1211 measures only 175mm wide by 70mm deep by 15mm high and weighs a mere 170g (less than 6 ounces) yet look at its features! Up to 1424 program steps, 80 character input line with full editing features, 18 user definable keys, 24 character alpha-numeric LCD display and built-in tone function are included.

An optional cassette interface is available for loading or dumping programs or data. The PC-1211 is battery operated, has an auto power off function, and maintains all programs and data in its memory even after the power has been turned off.

£91.26
Plus VAT + P&P £1.00
(cassette interface £13.00 plus VAT + P&P 50p)

NASCOM FIRMWARE IN EPROM

NASPEN £30.00 + VAT + 35p P&P
ZEAP 2 £50.00 + VAT + 50p P&P
NAS-SYS 1 £25.00 + VAT + 35p P&P
NAS-DIS £37.50 + VAT + 35p P&P
NAS-DEBUG £15.00 + VAT + 35p P&P
NAS-SYS 3 £40.00 + VAT + 35p P&P

NASCOM SOFTWARE ON TAPE

8K BASIC £15.00 + VAT + 50p P&P
ZEAP 2 £30.00 + VAT + 50p P&P

NASCOM HARDWARE

Motherboard £5.50 + VAT + 50p P&P
Mini Motherboard £2.90 + VAT + 50p P&P
3 amp PSU £32.50 + VAT + £1.50 P&P
VERO DIP board £12.50 + VAT + 50p P&P
FRAME £32.50 + VAT + £2.00 P&P
8 Amp PSU Built £140.00 + VAT + £2.75 P&P
I/O Board £45.00 + VAT + £1.00 P&P
Buffer Board £32.50 + VAT + 50p P&P

Microtype
Model 3 Case £24.50 + VAT + £1.50 P&P

NASBUS EPROM BOARD

Expands Nascoms 1 & 2 with up to 32K of Eprom. Accepts 2708s or 2716s. Also 24 pin socket for 8K ROM. Wait-state fitted for N2 users. Board can also support Nascom Page Mode Scheme.

£55 + VAT (Kit)
£70 (Built & tested) Plus £1.00 P&P + VAT

Prices correct at time of going to press.

INTERFACE COMPONENTS LTD.
OAKFIELD CORNER, SYCAMORE ROAD, AMERSHAM, BUCKS HP6 6SU
TELEPHONE: 02403 22307. TELEX 837788

• Circle No. 332



L&J COMPUTERS

3 CRUNDALE AVENUE, KINGSBURY NW9 9PJ 01-204 7525
THE "PET" SPECIALISTS



NEW LOW, LOW, 'PET' PRICES!!

Pet 8K (Large keys)	£420*
16K	£499*
32K	£630*
Ext cassette decks (+ counter)	£ 55*
PET Friction Feed printers	£350*
AVAILABLE FROM STOCK + VAT	
Printers Disc Drives	Sundries
PET 3023	PET 3040
PET 3022	Compu 400K
Centronic 779	Compu 800K
Spinwriter	Interfaces

**TRY US!
YOU WILL NOT BE
DISAPPOINTED**

SUPERPETS NOW EX-STOCK!

Tool kits: library cases
Disks: C12 Cassettes
Paper (roll & tractor feed)
Labels: Dust covers

SOFTWARE

As well as a full range of Petsoft and Commodore Software, we have some highly reliable "Home-Brewed" programs available.

STOCK CONTROL & INVOICING £60
(Handles up to 500 items — 32K) (180 on 16K). Stock depleted on invoicing, search etc. Cassette, disk (& print option).

CASH BOOK £90
Enter daily/weekly amounts — printout and totals, weekly/monthly analysis, totals and balances.

MACHINE HIRE Typewriter & Plant Hire Firms. £420

STOCK TAKING Cuts out all the hard work £230

OUTSIDE SERVICES (For Mini-Cabs Etc) £220

Sae for free software booklet

SPECIALS FOR THIS MONTH: PETMASTER SUPERCHIPS — UPGRADE YOUR PET EVEN MORE!

A FEW ONLY: Brand New CENTRONIC 779 t/f printers £590*
Brand New PET 2023 f/f printers £320*

THE "MUPETS" ARE HERE!
3 TO 8 PETS ONLY NEED 1 DISK DRIVE...
Daily demonstrations: Ring for details.



COMPLETE SYSTEMS
FROM £1700!!

THE SYSTEMS WE SUPPLY & INSTALL ARE COMPLETE:
ESTIMATES GIVEN FREE WITH NO HIDDEN EXTRAS:
FULL BACK-UP: GUARANTEED EXPERTISE.

* PRICES DO NOT INCLUDE VAT

PERSONAL SHOPPERS WELCOME
Phone & Mail Orders accepted.

ALL GOODS SENT SAME DAY WHEREVER POSSIBLE
LARGE S.A.E. FOR LISTS ETC.



• Circle No. 333

Introducing

PEARL



Product of:
Computer Pathways Unlimited, Inc.

A Powerful Application Generator
Produces Error-Free Automatic Rapid Logid
Generates C BASIC 2 Programs
and Compiles Them

Automatically Produces Programs For:

Menu Selection	Level I	£90
File Update/Edit	Level II	£325
Report Generator	Level III	£625
Indexed File Reorganisation		
Indexed Access		

All Prices Exclude V.A.T.

Contact UK Distributer — Tel: 01-670 4202

THE CLENLO CONQUEROR



A Z-80 Microcomputer in an attractive Metal Cabinet, containing a 12 slot motherboard. Two serial and two parallel I/O ports are standard. Will accept a variety of S-100 compatible floppy and hard disc Drives.

16K RAM 650.00

32K RAM 805.00

48K RAM 960.00

64K RAM 1115.00



8" 500K Double Density Floppy Disc Drive and Controller. 700.00
Add On Unit 410.00

All prices exclude VAT

Clenlo Computing Systems



Crown House
18 Gypsy Hill
London SE19 1NL
01-670 4202

• Circle No. 334



PET 2001



from £425

Commodore authorised dealers

TRS 80



from £365

From Radio Shack Corp.

APPLE II

from £695



authorised dealers

SORCEROR

from £730



authorised dealers

ADVANCED SYSTEMS



209

MICROCOMPUTERS ETC

For Hardware, Software, Peripherals, Consultancy and Competitive Prices.

BASIC SYSTEMS

PET 3016 (16K RAM and large keyboard) * £550.00
+ integral cassette * £425.00
PET 3032 (32K RAM and large keyboard) * £695.00

ACCESSORIES
IEEE-448/Centronics type parallel interface £35.00
IEEE to Pet Cable £19.00
IEEE to IEEE cable £24.00
PETSET 1 16 Channel AD Converter for your Pet - plug in ROM chip 8k and 16k 250k 500k c.w. all interfacing requirements £166.00

BASIC SYSTEMS

TRS 80, 4K Level I consisting of Keyboard with 4K memory, Video Unit, Cassette Drive and 240V power supply unit £365.00
TRS 80, 4K Level II (as above with Level II Basic) £425.00

TVJ 232 serial interface Centronics Parallel Printer Interface (direct to keyboard) £35.00
TRS 80, Voice Synthesizer £345.00
TRS Votbox - speech recognition system £135.00
Slinky floppy drive (complete with manual & wafers) £160.00

BASIC SYSTEMS

TRS 80, 16K Level II (as above with 16K memory) £499.00
TRS 80, Expansion Interface with 16K RAM £275.00
TRS 80, Expansion Interface with 32K RAM £360.00

ACCESSORIES
Radio Shack Phone Modem £160.00
UHF Modulators (encased with leads for 625 lines) £20.00
RAM upgrade (4-16K, 16-32K, 32-48K) supplied and fitted at our premises (Kit £80.00)

BASIC SYSTEMS

Apple II Plus computer - APPLESOFT extended basic in ROM - (16K RAM) - video output £695
ACCESSORIES
Real time clock/calendar card - interrupt, software controllable £14.00
Speechlab - provides voice control for the Apple £79.00
Supertalker - adds human speech output £104.00
ALF Music Synthesizer Card £113.00
A1-02 Data Acquisition Card £132.00
Graphics Tablet £116.00
AC Line Controller £270.00
RAM Upgrade (16-32K, 32-48K) £69.00
Hobby Prototype Card £20.00
Romplus-u, l/c, mixed text/graphic £105.00

BASIC SYSTEMS

Sorcerer (inc. UHF Modulator) Special low prices on limited stock
16K RAM £590.00
32K RAM £650.00
48K RAM £695.00

ACCESSORIES
Eddy Video Disk Unit £240.00
(High Resolution monitor with Integral 630K Dual Drive) £240.00
Eddy Vicoa Monitor £145.00
CP/M on Disk

ADVANCED SYSTEMS

TRS 80 Model II with integral B' floppy disk drive and up to 64K RAM Expandable up to 3 Megabytes Disk Storage (Available for demonstration - by appointment only). From £2,300
SUPERPETSYSTEM - CBX8032 Computer with 30 col. screen, CBM8050 - Dual Disk Drive giving 950K User Storage £695

PET BUSINESS SYSTEM

comprising
CBM 3032 Micro computer, CBM 3040 Dual Disk Drive, CBM 3022 Tractor Feed Printer and all cables
Special Offers!
£1799.00

DISKS

PET
CBM 3040 (dual drive) 343K User storage * £995.00
CompuLink (dual drive) 400K storage £1145.00
CompuLink (dual drive) 800K storage £299

TRSDrive
Microfloppy drive £239
Percom PD200 drive (110k) £275
Microfloppy drive (394K storage) £3500.00
Convus Hard Disk (11mb) £3500.00

APPLE
Apple Drive - 116K storage 1st drive £349.00
Apple Drive - 116K storage 2nd drive £299.00
Convus Hard Disk (11mb) £3500.00

SORCEROR

Eddy
Eddy Dual drive (630K storage) £1195.00
Convus Hard Disk (11mb) £3500.00

PRINTERS

PET
CBM 3022 (80 col) with PET graphics - tractor feed * £425.00
TRS80
TRS 80 Screen Printer (text - graphics) (1100) £345.00
New Radio Shack Micro Printer £245.00

GENERATOR
43 KSR Serial (pin or punch feed) (132 cols) £825.00
RACAL binder Printers - truly professional printers for microcomputers - high speed up to 280 cps, upper/lower case £499.00
OKI - parallel/serial (pin or punch feed) 40, 80, 132 cols (selectable) £825.00
Centronics 779 parallel tractor feed, 132 cols

DOLPHIN B360P tractor printer (125 cps directional) £90.00
Serial, parallel or IEEE interface. Available with Centronics Micro Printer (20, 40, 80 cols selectable) £395.00
GUME daisy wheel printers P O A
Head WH 14 serial (80, 96, 132 cols) £268.00
TCM100/MICROJUSH Thermal Printer (40 cols) inc. interface for PET/APPLE £349
SILENT PRINTER for APPLE... allows printing of high res. graphics

ETC.

Diskettes 5 1/4" (blank) boxed (min order 10) each from £3
C12 Cassettes (min order 10) each £0.35p
Ansaback phonemate telephone answering machine voice operated w/m cassette £190.00
Pace EZ-PHONE - Cordless Telephone £127.15
HiTech Video Monitors 9" 11" resp. £127.15
800KS - Large range of microcomputer related machines

STATIONERY

Letter Paper - most common sizes
Rebonds for MOT Printers - PROGRAMMABLE CALCULATORS, TEXAS INSTRUMENTS, Business Programmable Calculators - complete range. Send for list + prices. (We are authorised TI dealers).
IF YOU DON'T SEE IT - ASK IF WE HAVE IT

SOFTWARE

PET
PETSFT authorised dealers - over 160 programmes on cassette and disk. Send for catalogue.
STAGE ONE COMPUTERS S/W dealers - PETAD, Stock Control, etc. Send for list. £15.00
74 Common BASIC Programs on one tape P.O.A.
PETACT Business Software Sales at Wholesale Ledger, Invoicing, etc. £150.00
CBM DISK-BASIC (S/W) SOFTWARE £150.00
CONVUS (CBM) WORDPRO IV powerful word processor, low/high level esp. £75/150.00
COMBIS - STOCK CONTROL - gives complete stock report £150.00
COMBIS - BUSINESS INFORMATION SYSTEM - Storage & Retrieval of all types of company records £150.00

COM ACCOUNTS - Full Financial Business Accounting System incl: Sales, Purchase, Nominal Ledgers £650.00
COMPAY - Handles hourly, weekly or monthly paid employees £300.00
COMPLANNER - Personal information tool for the busy executive £50.00
IWE are authorised CBM Business Software Dealers. Send for List. £75.00
GO 1001 - Assembler Development System £138
GO 010 - Lisp Interpretive Language (Artificial Intelligence)

BRISTOL SOFTWARE FACTORY S/W dealers -
TRADER, ITEM, MONITOR, etc. - Send for details.
TRS 80
COMAC II SUITE - comprehensive accounting for TRS 80 (TVJ SOFTWARE) £75.00
STOCK CONTROL - complete inventory control - recorder level - P/O's etc. £115.00
CBASIC £75.00
FORTRAN includes compiler, relocatable assembler text editor and linking loader £96.00
PASCAL - tomorrow's programming language today £96.00
ELECTRIC PENCIL - powerful word processor allows full cursor movement, insert/delete, string search block movement, adjustable line length, justification on cassette £39
ELECTRIC PENCIL as above - disk version £95.00
LOWER CASE MOD KIT ONLY/FITTED for Electric Pencil £8.00/£28.00
DATA MANAGEMENT/REPORT GENERATOR - easily formats disk files, allows entry, edit, delete and list of records and retrieves data for display or calculation on screen or printer £180.00
HSM-2D DISK MONITOR - powerful system manipulates disk data, has 280 break routine £25.00
NEWDOS - TRS above but with further facilities: - £60.00
KBIK, Revis, Screen to printer in one step, DOS commands from BASIC, Level II, Superzap, Disassemble, load and save faster, list variables LIBRARY 100 - an assortment of 100 programs £49.00
SARGON CHESS - a 16K Level II, the 1979 Champ Version 1 £14.00

APPLE
CASHIER - Retail Store Management System £195
U-DRAW II - High Resolution graphics editor. Create a figure then rotate, expand, contract etc and store on disk £27.00
LSP - programming language suitable for research in artificial intelligence £30.00
3-MILE ISLAND - Complex disk based game simulating nuclear reactor £27.50
VISICALC - Instant Visual Calculation - provides a powerful planning and forecasting tool £52.00
APPLE WORD PROCESSOR - Complete text editing, storage and retrieval of text (disk based) £42.00
LITTLE GENUS - Comprehensive disk based Apple Soft Tutorial £35.00
ACT Appletwe and MUSE authorised software dealers - Many programs on cassette and disk. Send for list. £1.20
SORCEROR many programs available - send for list. £70.00
Word Processor Rompac Development Pac

* 5% DISCOUNT ALLOWED FOR EDUCATIONAL ESTABLISHMENTS

T&V JOHNSON (MICROCOMPUTERS ETC) LTD

Hours of business
Mon-Fri, 9.30 - 5.30
Sat. 9.00 - 12.30

Member of the TV Johnson Group of Companies
Bristol
148 Cowley Road, Oxford
OX4 1JJ
☎ (0272) 422061

+ Ansbacck eyes
and w/ends.
Telex 856893

Directors: D. R. V. de B. A. J. A. E.
T. S. Johnson, ABIGA, ACMB, FBSC, MBM
A. S. Barton, ACH, AJBIA, CIBAF.

PRICES EXCLUDE VAT, FREIGHT & HANDLING SEND OR
CALL FOR LIST OF MICROCOMPUTERS
(all prices correct at time of compilation)

DATA LINK

Microcomputer Systems Limited

Systems software for business, industrial and scientific applications

APPLE SYSTEMS

Apple II Plus	£695.00
1 MB 8" Disk Drives	£1550.00
Disk Drive with Controller card	£349.00
Disk Drive without Controller card	£299.00
16K Add-ons RAM	£69.00

FULL RANGE OF ACCESSORIES

including: —

Visicalc	£95.00
A1-O2 Data Acquisition Card	£180.00
Clock Card	£160.00
ROM Plus Board	£116.00

ALL PRICES EX VAT

APPLE SYSTEM — Latest Additions

DOS 3.3 (23% extra disc space)	£39.00
H.S. RS232/Bi-directional parallel Combined Interface	£120.00
Desktop Plan (from Visicalc people)	£64.00
H.S. Serial Interface	£80.00
Language Card with Pascal	£299.00
Fortran addition	£120.00
Pilot addition	P.O.A.
Appletel (for Prestel)	£595.00
Apple juice reserve power supply	£148.00
IEEE Interface	£212.00

Printers

Paper Tiger (with graphics)	£598.00
Centronics 737 (5 character sets. Bi-directional paper drive. R. Margin justification)	£580.00
Centronics 701	£1,115.00
Centronics 702	£1,310.00
Centronics 703	£1,625.00
Centronics 704	£1,655.00
Centronics 753	£1,655.00

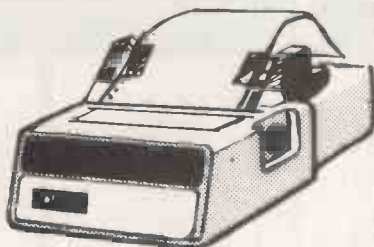

Consultancy Service

If the computer you buy is really going to do the job you want it to do — run your accounts, control your stock, solve your problem, or you name it . . . the selection of the computer system and the programs to run it must be made with the utmost care. Otherwise, grief, hassle and costly frustration may well be your unhappy lot.

As always, the answer is to consult an expert.

We have on tap a team of friendly experts who will happily analyse your problem, discuss with you your hopes and ambitions, and advise you on the feasibility of a computer solution. If the situation is on-going, they will then specify your software requirements and recommend a particular computer system.

Finally, they will cost the whole exercise.

Fortune smiles upon he who . . .

DISKETTES ETC

BASF Top Quality Unconditional 12 Month Guarantee

5.25" Mini Single Sided Soft Sector/Single Density	£25.00	(Box of 10)
5.25" Mini Single Sided Hard Sector/Single Density	£25.00	(Box of 10)
5.25" Mini Single Sided Soft Sector/Double Density	£26.00	(Box of 10)
5.25" Mini Double Sided Soft Sector/Double Density	£30.00	(Box of 10)
8" Single Sided Soft Sector/Single Density	£26.50	(Box of 10)
8" Single sided Soft Sector/Double Density	£27.50	(Box of 10)
8" Double Sided Soft Sector/Single Density	£40.00	(Box of 10)
8" Double Sided Soft Sector Double Density	£40.00	(Box of 10)

DISKETTE LIBRARY CASES

5.25" Mini Diskette Library Case for 10 Diskettes	£2.50
8" Diskette Library Case for 10 Diskettes	£3.00

DISKETTE TRAY WITH LOCKABLE LID

A6 5.25" Mini Diskette Tray with Lockable Lid:	30-40 capacity	£18.00
	60-80 capacity	£20.00

A5 8" Diskette Tray with Lockable Lid:	30-40 capacity	£25.00
	60-80 capacity	£28.00

9" Plain Listing Paper (per 2,000 sheets)	£16.00
---	--------

10% EDUCATIONAL DISCOUNT

STOP PRESS

Programmable Timer for Apple

Software controlled counter/timer for frequency/interval measurement, pulse/event counting, controlled frequency source, etc. 6 input/output channels. 16 bit counter resolution, 2 μ sec max clocking frequency. Remote stop/start.

£110.00

Z-80 Softcard for Apple

You've read about it, we can supply it. Send for full details and specification.

£180.00

WE CAN NOW ARRANGE INSURANCE FOR YOUR COMPUTER

We also stock an extremely comprehensive range of computer books

DATA LINK

10 Waring House, Redcliffe Hill, Bristol BS16TB
Telephone: Bristol (0272) 213427

• Circle No. 336

'TUSCAN' FROM TRANSAM



Take a step up to your next Computer!

THE CONCEPT

How many ways are there to build an S100 system? Not many, and all expensive. TUSCAN changes all that.

Five S100 boards on one single board — just for starters. Plus five extra slots for future expansion.

What a combination! Z80 and S100 with the TRANSAM total package of system and applications software.

THE PRICE RANGE

From £235 for complete main board kit to £1481 for 48K assembled with 2 x 5¼ drives.

THE HARDWARE

The first Z80 single board computer with integral S100 expansion. British designed to the new IEEE (8 BIT) S100 specification, the TUSCAN offers total system flexibility. A flexibility available now.

The board holds the equivalent of a Z80 cpu card, 8k ram, 8k rom video and I/O cards with 5 spare S100 expansion slots and offers a price/performance ratio which is hard to beat.

Just compare our price with a commercial S100 ten slot motherboard with this specification.

THE SOFTWARE

TUSCAN offers the user the choice of system monitor, editor, resident 8k basic, resident Pascal compiler or full CP/M disk operating system. All options are upwards

compatible and fully supported with applications software. Both 5¼" and 8" drives are supported in double density.

THE PACKAGE

TUSCAN is available in kit form or assembled. With several hardware and software options to suit your requirements and budget. Attractive desk top case also available holds 2 x 5¼" Drives.

TRANSAM

NOBODY DOES IT BETTER!

Send to Transam Components Ltd., 59/61 Theobald's Road, London WC1.

I am interested in the TUSCAN Z80 based single board computer
NEW LOW PRICES, send S.A.E. for further details.

Name _____

Address _____

Telephone _____

PCI/81

TRANSAM COMPONENTS LTD., 59/61 THEOBALD'S ROAD, LONDON WC1. TEL: 01-405 5240/2113

• Circle No. 337

£1150
+ VAT

VISUAL 100



The VISUAL 100 is a new microprocessor based video display terminal that offers total compatibility with the DEC VT100* from both a software and operator point of view.

For the operator, the detachable solid-state keyboard has been customized so that all key positions and LED indicators are in identical location to that of the VT100.

For the software, all codes and features have been implemented in a manner identical to the VT100 assuring plug-to-plug compatibility.

The big difference between the VISUAL 100 and the DEC VT100 is that the VISUAL 100 offers features not available on the VT100, or available only as extra-cost options. These added features include:

- ETCHED NON-GLARE FACEPLATE
Your operator will appreciate viewing characters through an etched non-glare faceplate. This feature assures crisp, sharp character resolution even in the brightest office environ-

ments. Further, the tilt screen feature allows an adjustable viewing angle, 10° to 15°, for optimal viewing comfort.

- ADVANCED VIDEO PACKAGE IS STANDARD
Blink, bold, reverse video, and underline video attributes which can be used alone or in any combination for enhanced video presentations.
- CURRENT LOOP INTERFACE IS STANDARD
A 20mA current loop interface as well as an EIA RS232C interface.
- BUFFERED PRINTER INTERFACE OPTION
This option allows independent print/communication baud rates and independent parity. The printer option also allows the VISUAL 100 to function as a controller between host and printer, using "XON XOFF" protocol. Printer busy can also be monitored using XON XOFF, or control line.

Seeing is believing, so see for yourself. For a demonstration and a pleasant surprise on quantity pricing of the VISUAL 100, call or write us today.

• Circle No. 338

£675
+ VAT

VISUAL 200



The VISUAL 200 is a new, low cost, microprocessor based video display terminal which truly stands above competitive teletype compatible terminals in its price range.

In addition to the most popular features available (or partially available) on competitive terminals, such as numeric pad, upper/lower case, editing, current loop, cursor addressing, columnar and field tab, etc., standard features which set the VISUAL 200 apart and reach the optimum in human engineering and operator comfort include:

- Detachable Keyboard
- Smooth Scroll
- Tilt Screen (10° to 15° viewing angle)
- Large 7 x 9 Dot Matrix Characters

Perhaps the most distinctive feature of the VISUAL 200 is the Switchable Emulation capability. A switch on the rear panel programs the terminal for code-for-code emulation of a Hazeltine 1500, ADDS 520, Lear Siegler ADM-3A or DEC VT-52. To an O.E.M. customer it means no change in software to displace the older, less powerful terminals in his product line with the new, reliable and low cost VISUAL 200. To a Distributor it means offering a single modern terminal which is compatible with all the software his customers have written for the older terminals. And you're not limited to merely emulating these older terminals; you can outperform them at the same time by taking advantage of the additional features of the VISUAL 200.

Reliability designed into the VISUAL 200 is evidenced by its solid state keyboard, single P.C. Board and self test diagnostics on power up.

Seeing is believing, so see for yourself. For a demonstration and a pleasant surprise on quantity pricing of the powerful, easy to use and reliable VISUAL 200, call or write us today.

Standard Features

- 24 x 80 Screen Format
- 7 x 9 Dot Matrix
- Upper/Lower Case
- Numeric Pad
- Background/Foreground
- Blink Line
- Insert/Delete Line & Character
- Columnar and Field Tab
- Set/Clear Tab
- Security Mode (non-display)
- Clear End Line, Field & Page
- Clear Line
- Clear Screen
- Line Drawing
- Current Loop or RS-232 Interface
- Secondary Channel
- Composite Video
- Serial Copy Port
- Hold Screen
- Baud Rates to 19,200
- Self Test
- Cursor Addressing
- Cursor Control Keys
- Read Cursor Address
- Typamatic Keys
- Smooth Scroll
- Microprocessor
- Detachable Keyboard
- Solid State Keyboard
- Read Terminal Status
- Tilt Screen
- Switchable Emulations

• Circle No. 339

THE FIRST MICROCOMPUTER WHOLESALER



We offer products from many manufacturers including:

Altos
Centronics
Century Data
Control Data
Datasouth
Dyna Byte
Exidy
Hazeltine
Houston Inst.

Impact Data
Industrial Micro
Integral Data
Intertec
Konan
LRC Eaton
Malibu
Micro Peripherals
N.E.C.

North Star
Ohio Scientific
Onyx
PerSci
Qume
Soroc
Televideo
Texas Instruments
Visual Technology

SIGMA (U.K.)
6, THE JAYS
BURGESS HILL,
SUSSEX

Telephone: 04446-44159

DATASOUTH DS180 HIGH SPEED MATRIX PRINTER

£1490
+ VAT



The Datasouth DS180 is a dot-matrix serial impact printer designed for high performance at an economical price. Application flexibility and a long list of standard features make the DS180 an ideal device for small business systems, distributed communications networks and intelligent terminals.

HIGH SPEED PRINTING

Utilizing 180 cps optimized bidirectional printing, the DS180 offers higher throughput than any printer in its class. Its 9-wire printhead produces highly legible 9x7 characters with decenders for lower case letters and true underlining. All 96 ASCII characters may be printed across a 132 column line at 10 characters per inch. Expanded characters (5 cps) may be selected for highlighting portions of the text.

USER PROGRAMMABLE

The DS180 offers a large number of user programmable features, yet is easy to operate. A unique programming keypad with a non-volatile memory makes printer set-up quick and simple. Top of form, horizontal and vertical tabs, perforation skip-over and auto line feed are just a few of the features the user may select. Communications status may also be programmed and monitored using the indicator panel lights and LED display.

ATTRACTIVE DESIGN

Compact desk-top packaging allows the DS180 to fit into almost any installation. Its noise dampening cover makes it suitable for use in a quiet office environment. The cartridge ribbon makes routine changes clean, fast and convenient.

MICROPROCESSOR ELECTRONICS

Through the use of state-of-the-art microprocessor electronics, reliability and maintainability have been greatly improved. The simple modular design of the DS180 provides easy access to all major components. A single printed circuit board contains both

the power supply electronics and digital controller for the printer. A self-test feature and diagnostic display panel help the user verify proper operation of the unit and isolate problems should they occur.

COMMUNICATIONS

Interfaces on the DS180 include RS232 and 20mA current loop serial interfaces, and a Centronics compatible parallel interface. Baud rates from 110-9600 and parity selection may be keyed in by the user for his specific application.

FORMS HANDLING

Adjustable tracings accommodate forms from 3-15 inches wide. A head-to-platen gap adjustment ensures optimum print quality on up to 8-part forms. Fanfold paper may be fed from the front or bottom of the DS180. A paper out sensor may be programmed to send a stop transmission character and sound an audible alarm.

QUALITY MANUFACTURING

Reliable performance is ensured by a stringent quality control program. Datasouth uses pretested, high reliability parts from leading manufacturers. Multiple tests are performed on sub-assemblies during each stage of production, with each completed unit undergoing a final 24 hour print test and burn-in. The DS180 carries a 90 day warranty on materials and workmanship.

• Circle No. 340

Micro General

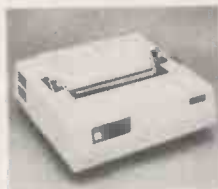

Presenting the **MICROLINE** family
Low cost, high performance **MATRIX** printers
featuring ...

- Quality and reliability using 9 x 7 matrix
- Programme selectable character size and line spacing
- 96 ASCII characters plus 64 Block Graphic Shapes
- No routine maintenance

Prices include 90 days part and labour warranty plus
FREE DELIVERY to U.K. Mainland. Price
excl. VAT

MICROLINE 80 — 80 cps uni-directional printing £360.00
— Parallel Centronics Interface
— Pin and Friction Feed

M80 Tractor Feed Option £ 38.00
M80 RS 232 Serial Interface £ 78.00

microline 82 — 80 cps bi-directional, short line seeking £510.00
— Parallel and Low Speed RS 232 Serial I/F
— Pin and Friction Feed

M82 Tractor Feed Option £ 38.00
M82 Roll Paper holder £ 13.00

M82 High Speed RS 232 Serial I/F + 256 char buffer £ 98.00
M82 High Speed RS 232 Serial I/F + 2048 char buffer £143.00

MICROLINE 83 — 120 cps bi-directional, short line seeking £799.00
— Parallel and Low Speed RS 232 Serial I/F
— 136 columns on up to 15 inch forms
— Tractor Feed standard fitting

M83 High Speed RS 232 Serial I/F + 256 char buffer £ 98.00
M83 High Speed RS 232 Serial I/F + 2048 char buffer £143.00

INTERFACE CABLES — State full details of Micro (Serial: £ 23.00)
(2 metres long) model plus I/O features. (Parallel: £ 27.00)

Maintenance Service available.
Educational discounts on request.

Remittance including VAT please to:
Micro General, 6 The Birchwoods, Tilehurst, Reading, Berks RG3 5UH
Tel: 0734 25226

• Circle No. 341

NOTICE TO ADVERTISER

From November 7th 1980
the **Practical Computing**
Advertising dept. will be at:

Practical Computing
room L311
Quadrant House
The Quadrant
Sutton
Surrey SM2 5AS

Tel: 01-661 3500 EXTN 3612

Advertisement Index

A		Datron Microcentre	202	Liveport	54	R	
Adda	201	Digitus	40	L & J Computers	208	Rair	118
Acorn Computers	52	3D Digital Design	194	Logitek	116	Research Machines	155
Aculab	30	DDP	34	London Computer Centre	171	Research Resources	26
ADJ Direct Supplies	184	Digitus	40	Lowe Electronics	21, 164, 168, 172		
AJ Harding (Molimerx)	22	Dragon Systems	176	LP Enterprises	35	S	
Almarc	128					Sadektronics	154
Anaspc	108	E		M		Science of Cambridge	80, 81
Anglia Consultants	165	Easicomp	176	MAP	196	Scope	38
Apex Micro Systems	200, 164	Electronic Systems	20	MAP21	38	Sharp Computer Applications	12, 13
Atlantc Data Systems	164	EMG	172	Melbourne House	198	SGS ATES	8, 9
Audiogenic	176	Encotel	159	Mendip	180	Sigma UK	212
		Equinox	33	Metrotech	39	Sirton	191
		Europhonics	151	M.H.G.	30	Small Developments	59
B				MIBF	187	Small Systems Engineering	36, 186, 204
Back Numbers	167	F		Micro 80	178	Software House	191
Barcellos	196	Feldon Audio	157	Microbusiness Centre	107	Southdata	28
BFI	190	Formdown	75	Microbyte	177	S Perry Univa	107
Beaver Systems	160	Fortronic	147	Microcentre	2	Stack	3
Bits & PCs	32	Friar Grove	38	MicroComputer Applications	24	Stage One	183
Business & Leisure Micros	174			Microdata	38	Strutt	59
Business Technology	192	G		Micro Digital	107	Strutt Semel	23
Buss Stop	28	Gate Microsystems	164	Micro General	213	Sumlock Bondain	162
Butel Comco	43	GP Industrial Electronics	173	Micropute	32	Supervision	192
Byte Shop Computerland	166	Graffcom	75	Microsense	63	Swanley Electronics	154
Bytronix	156	Gram Winter	14, 15	Microsolution	4	Systematics International	98, 150
		Guestel	101	Microsolve	34		
C				Micro systems	161	T	
Caddis	170	H		MicroStyle	192	Tags	51
Cambridge Computer Store	110	Hal Computers	189	Microtek	186	Tally Printers	204
Camden Electronics	150, 26	H B Computers	18	Microtrend	45	Tandy Computers	6, 7
Capital Computer Systems	152	Hebbitt Electronics	150	Mighty Micro	27	Tayburn (Fortronic)	31
Castle Electronics	25	Henry's Radio	187	Millbank	20	TBS	186
Centralex	158	Hewlett Packard	48			Telesystems	156
CB World	198	Hytech	206	N		Technomatic	185
Cetronic	202			Nascom Dealers	181	Tim Orr Design	160
Chromasonic	184, 199	I		Newbear	154	Transam	169, 211
Clearsons	180	ICE	188	Newtronics	195	Transdata	108
Clenlo	208	Infra	182	Northern Software Consultants	157	T & V Johnson	209
Codified	56	Instem	160	O		U	
Comart	115	Intelligent Artefacts	152	Owl Computers	160	U. Microcomputers	19
Commodore	88, 90, 92	Interface Components	207			V	
Compshop	214, 215	Intex Datalog	174	P		Paper Shack	23
Computech	203	Ithaca Intersystems	216	Practical Computing Announcement	213	Viasak	53
Computerbits	197			Personal Computers	117	Vision Business Systems	205
ComputerShop	188	K		Pete & Pam Computers	172	V & T Electronics	200
Computopia	36	Kansas City Systems	158	Petsoft	113	W	
Control Universal	178	Karradawn	182	Phippis Associates	110	Warren Point	194
Crofton	26	Keytronics	180	Portable Micro Systems	163	Westwood	196
Crystal	19, 194	KGB	175	Professional Data Systems	190	Weyfringe	179
CS SC	184	Knight TV	24	Professional Software	124		
Cumana	153	KSL	28	Program Power	78	X	
Currys Micro-C	10, 11			PR Daly & Co	168	Xitan	206
				Purley	190	Z	
D		L				Zenith Heathkit	19, 21, 23
Datalink	210	Leicester Computer Centre	124	Q		Zilog	79
David Richards	170	Lifeboat Associates	16, 17	Qtek	182		
Davincl	21	Lionhouse Micros	72				

NEW REDUCED PRICES

8K £399
16K £499
32K £599
RRP £795 for 32K



EXTENDED WARRANTY BY COMPUKARE

The PEDIGREE PETS Very popular for home & business use. 8K Microsoft Basic in ROM. 8K Pet 32K & 16K with new improved keyboard. All with green screen. Cassette Deck £55 extra. Full range of software available. Interface PET IEEE — Centronics Parallel Decoded **£77.00 + VAT**

**NOW IN STOCK
SUPER 80 COLUMN PET**
only **£825 + VAT**

SPECIAL SCOOP GET YOURSELF A PRINTER FOR YOUR PET AND SAVE A FORTUNE

only **£299 + VAT**



Interface Cards £49
Full Pet Graphics including cables. Ready to go. **EX-STOCK.**
Interfaces with APPLE, PET, EXIDY, TRS80, COMPUKIT and NASCOM.

NASCOM 2 DISC DRIVES

Add a powerful, double density, mini floppy disc to your Nascom system.

- Disc Controller Card (includes Nasbus 6 S100 interface)
- Will control 4 Drives.
- CPM operating system.
- Extended Disc Basic Compiler.
- Power supply included



One Disc System — **£499 + VAT**
Additional Disc Unit — **£299 + VAT**

NASCOM 2 GAMES TAPE

featuring Space Invaders and Android Nim, Re-numbering program and other goodies!

£7.50 + VAT

NEC SPINWRITER

only **£1490 + VAT**



NEC's high quality printer uses a print "thimble" that has less diameter and inertia than a daisy wheel, giving a quieter, faster, more reliable printer that can cope with plotting and printing (128 ASCII characters) with up to five copies, friction or tractor fed. The ribbon and thimble can be changed in seconds. 55 characters per second bidirectional printing — with red/black, bold, subscript, superscript, proportional spacing, tabbing, and much, much more.

TEAC DISK DRIVES

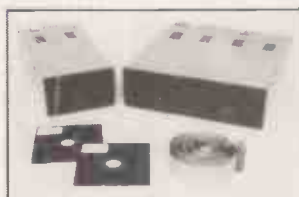

- TEAC FD-50A has 40 tracks giving 125K Bytes unformatted single density capacity.
- The FD-50A can be used in double density recording mode.
- The FD-50A is Shugart SA400 interface compatible.
- Directly compatible with Tandy TRS80 expansion interface.
- Also interfaces with Video Genie, SWTP, Heathkit, North Star Horizon, Superbrain, Nascom, etc, etc.
- Address selection for Daisy chaining up to 4 Disks.
- Disks plus power supply housed in an attractive grey case.

Single Disk Drive **£225 + VAT** Double Disk Drive **£389 + VAT**

COMP POCKET COMPUTER GREATEST BREAKTHROUGH YET

£99.90 + VAT



COMPUTER POWER THAT ONCE FILLED A ROOM CAN NOW BE CARRIED IN YOUR POCKET!

- Programs in BASIC • "QWERTY" Alphabetic Keyboard • 1.9K Random Access Memory • Long Battery Life.

Computer power that once filled a room can now be carried in your pocket! It's easy to load with ready-to-run software from cassette tape (interface and recorder optional) or program it yourself in easy-to-learn BASIC. 24-character liquid crystal readout displays one line at a time. Special feature is advanced non-volatile memory allows you to power on and off without losing the contents of memory. Note: Memory must be transferred to tape before changing batteries. Automatic statement compaction squeezes every ounce of memory space. Features power-off retention of programs and data. Powerful resident BASIC language includes multiple statements, math functions, editing, strings, arrays and much more. Multiple program loading capability subject to RAM availability. Carrying case and batteries included.

Program	Each	Program	Each
Real Estate	£13.95	Games 1	£8.95
Civil Engineering	£13.95	Business Statistics	£10.95
Aviation	£13.95	Business Financial	£10.95
Math Drill	£8.95	Personal Financial	£10.95

EXTENDED WARRANTY BY COMPUKARE



ACULAB FLOPPY TAPE

The tape that behaves like a disc, for TRS-80 LEVEL 2.

only **£169 + VAT**

Connects directly to TRS-80 Level 2 Keyboard. Operating and file handling software in ROM. 8 commands add 12 powerful functions to Level 2 BASIC.

COMMERCIAL • EXPANDABLE • COMPLETE TRS 80 • MODEL II



EXTENDED WARRANTY BY COMPUKARE

COMING SOON
26 megabyte
Hard Disc
multi-user
DOS

WE USE THIS MACHINE IN OUR BUSINESS

1 DISK EXPANSION Room for 3

500K per Drive gives total of 1.5M Byte — 1 Drive plus Cabinet **£799 + VAT**



This new unit from the world's most successful micro company is now available immediately with software.

The basic unit comes complete with 64 thousand characters (bytes) of Memory. The built in 8" Floppy disc adds another 1/2 million extra characters including the disc operating system. More disc expansion is now available.

The Model II is a complete unit with a full keyboard including a numeric pad and 12" screen which gives 24 lines of 80 characters. The computer is supplied with both the disc operating system and the Level III Basic.

A full self test routine is written into the power up procedure to eliminate incorrect operation. Both serial and parallel expansion sockets are standard. A printer is a plug-in operation. Both hardware and software necessary to talk to a mainframe are included. Terminal usage is very possible. With the addition of CPM2 you can operate with COBOL, FORTRAN, MBASIC, CBASIC in which languages are many other applications packages i.e. accounting, payroll stock etc.

64K 1-Disk Model II **£1995.00 + VAT**
RRP £2250.00

CP/M2	£95.00	C BASIC	£75.00	FORTRAN	£220.00
CIS COBOL	£400.00	M BASIC	£155.00	WORDSTAR	£255.00

EPROM 2716 **£12.50 + VAT**

EXTENDED WARRANTY BY COMPUKARE

only **£325 + VAT**



TRS80 LEVEL 2 16K

Fully converted to UK T.V. Standard. Comes complete with easy to follow manuals. UK Power Supply — Cassette Leads — Sample tapes. Special box to enable you to plug into your own TV. Recommended for first-time-buyers. Just plug in and go. Full Range of Software Available

Interface to Centronics Parallel for TRS80 **£75.00 + VAT**

only **£295 + VAT**

Expand your TRS80 by 32K

TRS80 EXPANSION INTERFACE

32K Memory on board. Centronics parallel port. Disk controller card. Real time clock. Requires Level II Basic. Interface for 2 cassette decks, complete with power supply.



THE VIDEO GENIE SYSTEM

EG3000 Series



16K **£289 + VAT**

WITH 16K user RAM plus extended 12K Microsoft BASIC in ROM • Fully TRS-80 Level II software compatible • Huge range of software already available • Self contained, PSU, UHF modulator, and cassette • Simply plugs into video monitor or UHF TV • Full expansion to disks and printer • Absolutely complete — just fit into mains plug.

COMING SOON
THE MARTELL TV GAME

NOBODY CAN GET NEAR OUR PRICES EXCEPT OUR CUSTOMERS

RRP £540

only **£399** + VAT

ANADEX DP8000

Super Quality — Low cost printer. Tractor Feed with full 96 ASCII character set. Accepts RS232C at band rates between 100 and 9600 and Parallel Bit data. Attaches either directly or through interfaces to Pet, Apple TRS80, Sorcerer, Nascom, Compukit etc.

EXTENDED WARRANTY BY COMPCARE

THE NEW ANADEX DP9501

A PROFESSIONAL PRINTER

- Bi-directional printing
- Up to 220 chars/line with 4 print densities
- 500 char buffer
- RS232C and Centronics Parallel interface built in
- Full software control of matrix needles allowing graphics capability
- 200 chars/sec • Adjustable width tractor feed.

All this for only **£895 + VAT.**

EXTENDED WARRANTY BY COMPCARE

THE ATARI VIDEO COMPUTER GAMES SYSTEM

Atari's Video Computer System now offers more than 1300 different game variations and options in twenty Game Program™ cartridges!

Most Cartridges only **£13.90 + VAT**

Prices may vary with special editions Basic Maths, Airsea Battle, Black Jack, Breakout Surround, Spacewar, Video Olympics, Outlaw, Basketball Hunt & Score*, Space War, Sky Diver, Air Sea Battle, Codebreaker*, Miniature Golf.

Extra Paddle Controllers — **£14.90 + VAT**

Keyboard Controllers — **£16.90 + VAT**

SPACE INVADERS NOW IN STOCK £25

EXTENDED WARRANTY BY COMPCARE

NEW TV GAME BREAK OUT

Has got to be one of the world's greatest TV games. You really get hooked. As featured in ET1. Has also 4 other pinball games and lots of options. Good kit for up-grading old amusement games.

MINI KIT — PCB, sound & vision modulator, memory chip and de-code chip. Very simple to construct. **£14.90 + VAT**

OR PCB £2.90 MAIN LSI £8.50 Both plus VAT

WE ARE NOW STOCKING THE APPLE II EUROPLUS AT REDUCED PRICES

16K **£599**

32K **£649**

48K **£659** + VAT

Getting Started APPLE II is faster, smaller, and more powerful than its predecessors. And it's more fun to use too because of built-in features like:

- BASIC — The Language that Makes Programming Fun.
- High-Resolution Graphics (in a 54,000-Point Array) for Finely-Detailed Displays.
- Sound Capability that Brings Programs to Life.
- Hand Controls for Games and Other Human-Input Applications.
- Internal Memory Capacity of 48K Bytes of RAM, 12K Bytes of ROM; for Big-System Performance in a Small Package.
- Eight Accessory Expansion Slots to let the System Grow With Your Needs.

You don't need to be an expert to enjoy APPLE II. It is a complete, ready-to-run computer. Just connect it to a video display and start using programs (or writing your own) the first day. You'll find that its tutorial manuals help you make it your own personal problem solver.

EUROPE'S FASTEST SELLING ONE BOARD COMPUTER

COMPUKIT UK101

- ★ 6502 based system — best value for money on the market.
- ★ Powerful 8K Basic — Fastest around
- ★ Full Qwerty Keyboard
- ★ 4K RAM Expandable to 8K on board.
- ★ Power supply and RF Modulator on board.
- ★ No Extras needed — Plug-in and go.
- ★ Kansas City Tape Interface on board.
- ★ Free Sampler Tape including powerful Disassembler and Monitor with each Kit.
- ★ If you want to learn about Micros, but didn't know which machine to buy then this is the machine for you.

40 pin Expansion Jumper Cable for Compukit expansion **£8.50 + VAT**

Build, Understand and Program your own Computer for only a small outlay. **KIT ONLY £179 + VAT NO EXTRAS NEEDED**

Available ready assembled, tested & ready to go **£229 + VAT**

NEW MONITOR FOR COMPUKIT UK101

- In 2K Eprom 2716
- Allows screen editing
- Saves data on tape
- Flashing cursor
- Text scrolls down

£22.00 + VAT

FOR THE COMPUKIT	Game Packs		
Assembler/Editor	1. Four Games	£5.00	Super Space Invaders (8K) £8.50
Screen Editor Tape	2. Four Games	£5.00	Space Invaders £5.00
	3. Three Games 8K only	£5.00	Chequers £3.00
			Real Time Clock £3.00
			Case for Compukit £29.50

All Prices exclusive VAT

HITACHI PROFESSIONAL MONITORS

9" — ~~£129~~ **£99.95**

12" — ~~£199~~ **£149**

- Reliability Solid state circuitry using an IC and silicon transistors ensures high reliability.
- 500 lines horizontal resolution Horizontal resolution in excess of 500 lines is achieved in picture center.
- Stable picture Even played back pictures of VTR can be displayed without jittering.
- Looping video input Video input can be looped through with built-in termination switch.
- External sync operation (available as option for U and C types)
- Compact construction Two monitors are mountable side by side in a standard 19-inch rack.

EXTENDED WARRANTY BY COMPCARE

ENGLISH COLOUR TV/ AMERICAN NTSC COLOUR MONITOR

Suitable for Apple, Atari and Texas 99/4 **£295 + VAT**

8MHz Super Quality Modulators	£4.90
6MHz Standard Modulators	£2.90
C12 Computer Grade Cassettes	10 for £4.00
Anadex Printer Paper — 2000 sheets	£25.00
Floppy Discs 5 1/4" Hard and Soft Sector	£3.50
Floppy Disc Library Case 5 1/4"	£3.50
Verocases for Nascom 1 & 2 etc.	£24.90
Keyboard Cases	£9.90

MEMORY UPGRADES

16K (8 x 4116) **£29.90 + VAT**

4K Compukit (8 x 2114) **£29.90 + VAT**

SPECIAL OFFER

We will part exchange your Sinclair ZX80 for any of our products.

Refurbished ZX80's — fully guaranteed **£69.90 + VAT** (Supply dependant upon stocks).

We have one of the largest collections of Computer Books under one roof, along with racks of software for the PET and TRS80. **Come and see for yourself.**

NOW OPEN

OUR NEW SHOWROOM & SALES CENTRE AT

311 Edgware Road, London W2.

Telephone: 01-441 2922

We give a full one year's warranty on all our products.

SPECIAL — ONCE IN A LIFETIME OFFER!

RRP £740 + VAT

16K **£399**

32K **£449** + VAT

48K **£499** + VAT

EXIDY SORCERER

For Personal or Business Use.

32K or 48K memory. 8K Microsoft Basic in ROM. Dual Cassette I/O, RS232 I/O. Parallel I/O (Centronics). Expansion available through optional extra S100 Motherboard. 69 Key keyboard including 16 key numeric pad.

EXTENDED WARRANTY BY COMPCARE

Please add VAT to all prices — including delivery. Please make cheques and postal orders payable to **COMP SHOP LTD.**, or phone your order quoting **BARCLAYCARD, ACCESS, DINERS CLUB** or **AMERICAN EXPRESS** number. **CREDIT FACILITIES ARRANGED** — send S.A.E. for application form.

MAIL ORDER AND SHOP:

14 Station Road, New Barnet, Hertfordshire, EN5 1QW (Close to New Barnet BR Station — Moorgate Line). Telephone: 01-441 2922 (Sales) 01-449 6596 Telex: 298755 TELCOM G

NEW WEST END SHOWROOM:

311 Edgware Road, London W2. Telephone: 01-262 0387

OPEN — 10am - 7pm — Monday to Saturday

★ IRELAND: 80 Marlborough Street, Dublin 1. Telephone: Dublin 749933

★ **COMP SHOP USA**, 1348 East Edinger, Santa Ana, California, Zip Code 92705. Telephone: 0101 714 5472526

COMP SHOP "Europes Largest Discount Personal Computer Stores"

BARCLAYCARD VISA DINERS CLUB INTERNATIONAL

COMP COMPUTER COMPONENTS (Part of the Compshop Ltd. Group)

At Intersystems, "dump" is an instruction.

Not a way of life.

(Or, when you're ready for IEEE S-100, will your computer be ready for you?)



We're about to be gadflies again.

While everyone's been busy trying to convince you that large buses housed in strong metal boxes will guarantee versatility and ward off obsolescence, we've been busy with something better. Solving the *real* problem with the first line of computer products built from the ground up to conform to the new IEEE S-100 Bus Standard. Offering you extra versatility in 8-bit applications today. And a full 16 bits tomorrow.

We call our new line Series II™. And even if you don't need the full 24-bit address for up to 16 megabytes (!) of memory right now, they're something to think about. Because of all the perform-

ance, flexibility and economy they offer. Whether you're looking at a new mainframe, expanding your present one or upgrading your system with an eye to the future. (Series II boards are compatible with most existing S-100 systems and *all* IEEE S-100 Standard cards as other manufacturers get around to building them.)

Consider some of the features: Reliable operation to 4MHz and beyond. Full compatibility with 8- and 16-bit CPUs, peripherals and other devices. *Eight* levels of prioritized interrupts. Up to 16 individually-addressable DMA devices, with IEEE Standard overlapped operation. User-selectable functions addressed by DIP-switch or jumpers, eliminating soldering. And that's just for openers.

The best part is that all this heady stuff is available *now!* In our advanced processor—a full IEEE Bus Master featuring Memory Map™ addressing to a full megabyte. Our fast, flexible 16K Static RAM and 64K Dynamic RAM boards. An incredibly versatile and

economical 2-serial, 4-parallel Multiple I/O board. 8-bit A/D-D/A converter. Our Double-Density High-Speed Disk Controller. And what is undoubtedly the most flexible front panel in the business. Everything you need for a complete IEEE S-100 system. Available separately, or all together in our new DPS-1 Mainframe!

Whatever your needs, why dump your money into obsolete products labelled "IEEE timing compatible" or other words people use to make up for a lack of product. See the future now, at your Intersystems dealer or call/write for our new catalog. We'll tell you all about Series II and the new IEEE S-100 Bus we helped pioneer. Because it doesn't make sense to buy yesterday's products when tomorrow's are already here.

InterSystems™

Ithaca Intersystems (UK) Ltd.,
Coleridge Lane, Coleridge Road,
London N8 8DD.

Telephone: 01-341-2447/Telex: 299568

